



Products Catalog

COMMERCIAL AND INDUSTRIAL
SB300

A Regal Brand



Quick Reference Guide

1	General Information
11	Application Information
17	Variable Speed Information
21	Single Phase
36	General Purpose Three Phase
68	Severe Duty
77	Explosion Proof
85	Medium Voltage
87	Inverter Duty "Max" Family
94	PMDC
96	IEC Motors
99	Brake Motors
101	Farm Duty / Agricultural
107	Washdown - Painted and Stainless Steel
113	Pump Motors (Fluid Handling)
140	HVAC / Air Moving
162	OEM Replacements
168	Definite Purpose
177	Modifications through MOD Central
188	Kits and Accessories
212	Index
254	Terms and Conditions

Our Founding Principles

- Serve customers according to their needs
- Produce the most efficient and long-lasting motors
- Commit to new technology and research
- Expand and diversify into new markets

Defining the Next Generation of Power

Since 1913, Marathon Electric has developed a reputation for conservative motor designs and highly engineered products used in a vast array of commercial and industrial applications around the world.

Marathon Electric has built on our legacy of innovation by combining magnetics and motors into a single leading technology. The use of Magnology™ has led to the development of the next generation of technology in motor efficiency and performance, the SyMAX™ motor.

The SyMAX™ permanent magnetic AC motors offer unique solutions for today's demanding applications. This product's unparalleled power density, unprecedented performance and unmatched efficiency is another industry first. Turn to page 206 for more information on the SyMAX™ motor solution.

SyMAX™

THE NEXT GENERATION OF POWER



Our New Corporate Identity is Simply "Regal"



SIMPLE.

Regal-Beloit Corporation, the parent of Marathon Electric, is in the midst of simplification. We are streamlining our business processes, standardizing our computer systems, and improving our communications – all with the idea of making it easier for customers to do business with us.

DYNAMIC.

As a corporation, we are becoming a more dynamic enterprise—continuously innovating and growing to reach more customers in more markets. And we are doing so with the confidence that comes with our years of industry experience.



BOLD.

As we bring life to the new Regal identity, our brand boldly reflects our corporate objective to become a more focused, integrated and customer centric company.

As a premier Regal brand, Marathon Electric will continue as a dynamic and customer focused brand serving partners around the world. The Marathon Electric brand promise remains providing customers with a vast array of efficient solutions for commercial and industrial applications performing every day for the long run.

REGAL

Table of Contents

	Page No.	Page No.
One Regal	1	
General Information	5 - 9	
Nameplate Information	5	
Model number nomenclature	6	
Doing business with Marathon Electric	7	
Operation, Maintenance and Storage	8	
Service and Warranty	9	
Submittal data	9	
Application Information	11 - 18	
Agency Information	11	
Mechanical and Electrical considerations	11	
Hazardous Duty™ overview	12	
Terminology	15	
Formulas and Conversion factors	16	
Variable Speed Information	17 - 18	
Guidelines for general purpose motors on VFD	17	
Application considerations	18	
NEMA MOTORS (AC Induction)		
General Purpose Single Phase (NEMA Service Factor)		
Dripproof		
Rigid Base	21	
Extended Thru-Bolt, Split Phase, Steel endshield	22	
Resilient Base (Single and Two-Speed)	24	
C-Face Footless	27	
C-Face Footed (Rigid Base)	28	
Totally Enclosed		
Rigid Base	29	
C-Face Footless	31	
C-Face Footed (Rigid Base)	32	
C-Face Footed (Removable Base) - Four in One	33	
Hazardous Duty™ Division 1 Explosion Proof, Class I and II, Groups C (as noted), D, F, G		
Rigid Base and Resilient Base	34	
C-Face Footless and C-Face Footed (Rigid Base)	35	
Special Purpose Single Phase (1.0 Service Factor)		
Dripproof		
Rigid Base	23	
Resilient Base	25	
General Purpose Three Phase		
Dripproof		
Rigid Base, 50 Hz, Standard Efficiency	176	
Rigid Base,	36	
C-Face Footless	40	
C-Face Footed (Rigid Base)	41	
Rigid Base, NEMA Premium® XRI® Efficiency	42	
Rigid Base, NEMA Premium® Globetrotter®	45	
Medium Voltage - NEMA Premium® XRI® Efficiency	86	
Totally Enclosed		
Rigid Base,	47	
Blue Chip®, Rigid Base, Standard and EPAct Efficiencies	48	
C-Face Footless	53	
C-Face Footed (Rigid and Removable Base)	55	
Rigid Base, NEMA Premium® XRI® Efficiency	58	
C-Face Footed (Rigid Base), NEMA Premium® XRI® Efficiency	62	
Rigid Base, NEMA Premium® Globetrotter®-NEMA Efficiency	63	
C-Face Footless NEMA Premium® Globetrotter®-NEMA Efficiency	66	
C-Face Footed (Rigid Base), NEMA Premium® Globetrotter®-NEMA Efficiency	66	
Severe Duty	68	
Blue Chip® Severe Duty, Rigid Base, NEMA Premium® XRI® Efficiency	69	
Blue Chip® Severe Duty IEEE-841, Rigid Base, NEMA Premium® XRI® Efficiency	74	
Medium Voltage - NEMA Premium® XRI® Efficiency	86	
Hazardous Duty™, Division 1 Explosion Proof, Class I only, Groups C (as noted), D		
Blue Chip®, Rigid Base, EPAct Efficiency	77	
Hazardous Duty™, Division 1 Explosion Proof, Class I and II, Groups D, F, G		
Blue Chip® Severe Duty, C-Face Footed (Rigid Base)	78	
Hazardous Duty™, Division 1 Explosion Proof, Class I and II, Groups C (as noted), D, F, G		
Steel frame, Rigid Base	79	
Blue Chip® Severe Duty, Rigid Base, EPAct Efficiency	73	
C-Face Footless, Standard Efficiency	80	
Blue Chip® Severe Duty, Rigid Base, NEMA Premium® XRI® Efficiency	82	
Black Max® Vector Duty Explosion Proof, C-Face Footed (Rigid Base)	90	
Blue Max® Vector Duty Explosion Proof with Encoder, C-Face Footed (Rigid Base)	91	
Hazardous Duty™, Division 2/Zone 2		
Totally Enclosed, Class I		
Blue Chip®, Severe Duty, Rigid Base, NEMA Premium® XRI® Efficiency	69	
Blue Chip® Severe Duty IEEE-841, Rigid Base, NEMA Premium® XRI® Efficiency	74	
Medium Voltage	85	
Inverter (Vector) Duty: "MAX"-series		
AC Variable Speed motors		
microMAX® Totally Enclosed, C-Face Footless and C-Face Footed (Rigid Base)	87	
Max-Plus (with Encoder), Totally Enclosed, C-Face Footed (Rigid Base)	88	
Black Max® Totally Enclosed, C-face Footed (Rigid Base)	89	
Blue Max® Totally Enclosed, Rigid Base and C-Face Footed (Rigid Base)	91	
Black Max® Explosion Proof, C-Face Footed (Rigid Base)	90	
Blue Max® Explosion Proof, with Encoder, C-Face Footed (Rigid Base)	92	
Blue Max® Brakemotor, Totally Enclosed, C-Face Footed (Rigid Base)	93	
NEMA MOTORS (Permanent Magnet DC)		
SCR Rated, Totally Enclosed, C-Face Footed (Removable Base)	94	
Washdown, SCR Rated, Totally Enclosed, C-Face Footed (Removable Base)	95	
Low Voltage, Totally Enclosed, C-Face Footed (Removable Base)	95	
IEC METRIC MOTORS (AC Induction)		

Table of Contents

	Page No.		Page No.
General Purpose Three Phase			
Totally Enclosed			
Globetrotter® - B3 mount	96	Condenser Fan/Heat Pump, PSC, Dripproof, Resilient Ring, Thru-Bolt	144
Globetrotter® - B14 and B35 (flange) mount	98	Condenser Fan/Heat Pump, PSC, Open Air Over, Thru-Bolt, Shaft Up or Horizontal	141
Flange Kits	213	Condenser Fan/Heat Pump, PSC, Open Air Over, Thru-Bolt, Shaft Down	142
Definite Purpose Motors			
Air Compressor 168			
Automotive Duty			
T-Frame: GM 7E-TA (Blue ChipR Severe Duty IEEE-841, . Rigid Base, NEMA Premium® XRI®	74	Condenser Fan/Heat Pump, PSC, Open Air Over, Resilient Ring, Thru-Bolt	143
T-Frame: Ford EM-1 (Blue Chip®, Severe Duty, Rigid Base, NEMA Premium® XRI®	69	Condenser Fan/Heat Pump, PSC, Open Air Over, Rigid Base, Shaft Up or Horizontal	143
Brakemotors			
Single Phase, Totally Enclosed, C-Face Footed (Removable Base)	99	Condenser Fan/Heat Pump, Three Phase, Open Air Over, Belly Band/Resilient Ring, Shaft Up or Horizontal	146
Three Phase, Totally Enclosed, Rigid Base	99	Commercial Condenser Fan/Heat Pump, PSC, Open Air Over, Belly Band, Shaft Up	144
Three Phase, Totally Enclosed, C-Face Footless	99	Commercial Condenser Fan/Heat Pump, PSC, Resilient Base, Shaft Up or Horizontal	145
Three Phase, Totally Enclosed, C-Face Footed (Removable Base)	100	Commercial Condenser Fan/Heat Pump, Three Phase, Dripproof, Belly Band, Shaft Up	145
Blue Max® Vector Duty Brakemotor, C-Face Footed (Rigid Base)	93	Exhaust Ventilator, Single Phase, Dripproof, C-Face Footless - Single and Two Speed	155
Brake kits: Four-in-One and Black Max.	214	Exhaust Ventilator, Single Phase, Explosion Proof, C-Face Footless	35
Cooling Tower			
Single-Speed, Blue Chip® Severe Duty, Three Phase, Totally Enclosed, Rigid Base	68	Fan & Blower - Direct Drive, ME-CAN-DO mutli-horsepower	160
Two-Speed, Blue Chip® XRI® Severe Duty, Three Phase, Totally Enclosed, Rigid Base	169	Fan & Blower - Direct Drive, PSC, Open Air Over, Resilient Ring	149
Farm Duty / Agricultural			
Aeration Fan, Single Phase, TEAO, Rigid Base (see HVAC/Air Moving section)	140	Fan & Blower - Direct Drive, PSC, Open Air Over, Resilient Ring, Thru-Bolt mount	147
Fan - Single Phase Capacitor Start, TEAO, Rigid Base - High Efficiency	102	Fan & Blower - Direct Drive, PSC, Open Air Over, Extended Thru-Bolt, 460 Volt	148
Fan - Single Phase, TEAO, Resilient Base- Thru Bolt	104	Fan & Blower - Direct Drive, PSC, Open Air Over, Torsion Flex mount	148
Fan - PSC, TEAO, Resilient Base-Thru Bolt - Variable Speed	103	Fan & Blower - Direct Drive, PSC, Open Air Over, Belly Band Thru-Bolt, Double Shaft	149
Fan - Single Phase, TEAO, Direct Drive-Thru Bolt - Single and Two Speed	106	Fan & Blower - Split Phase, Dripproof, Resilient Base - Single and Two Speed	150
High Torque, Single Phase, TEFC, Rigid Base	101	Fan & Blower - Capacitor Start, Dripproof, Resilient Base - Single and Two Speed	152
High Torque, Single Phase, TEFC, C-Face Footed (Rigid Base)	101	Fan & Blower - Split Phase and Capacitor Start, Totally Enclosed, Resilient Base - Single and Two Speed	153
Extra-High Torque Chore Motor®, Single Phase, TEFC, Rigid Base	102	Fan & Blower - Single Phase, Explosion Proof, Resilient Base	34
Auger Drive, Single Phase, TEFC, N-Flange	102	Fan & Blower - Three Phase, Dripproof, Resilient Base - Single and Two Speed	154
Crop Dryer, Single Phase, Dripproof/Air Over, Rigid Base	105	Fan & Blower - Three Phase, TEAO, Resilient Base	153
Crop Dryer, Three Phase, Dripproof/Air Over, Rigid Base	105	Furnace Blower (see Fan & Blower motors)	
Grain Stirring, Single Phase, TEFC, Rigid Base	103	Furnace Blower - PDQ mount	155
Incubator/Hatchery Vent Fan, PSC, TEAO, Thru-Bolt	106	Kiln Duty	172
Center Pivot Irrigation, Three Phase, TEFC, with Drip Cover	106	ME-CAN-DO (Multi-Horsepower), Condenser Fan, PSC, TEAO, Thru-Bolt	160
HVAC motors (Air Moving)			
Aeration Fan (see also Farm/Ag Duty)	140	ME-CAN-DO (Multi-Horsepower), Fan & Blower - Direct Drive, PSC, Open Air Over, Resilient Ring, Thru-Bolt	161
Attic Fan	140	Two-Speed, One-Winding and Two-Winding, Variable Torque, Three Phase, Dripproof, Rigid Base	170
Centrifugal Fan	141	Oil Burner, PSC, 48M flange mount	156
Circulator Pump, Single Phase, Dripproof - see also Pump/Fluid Handling section	159		
Condenser Fan/Heat Pump, "ME-CAN-DO" multi-horsepower	160		



Table of Contents

	Page No.		Page No.
Oil Burner, Split Phase and Capacitor Start, 48M and 48N flange mount	156	Close Coupled Pump, JP, Three Phase, Totally Enclosed, C-Face Footed (Rigid Base).	130
Oil Burner, Split Phase and Capacitor Start, 56C Footless.	157	Fire Pump, Three Phase, Dripproof, Rigid Base	131
Oil Burner, Three Phase, C-Face Footless (see also Centrifugal Pump, Three Phase)	157	Jet Pump (single compartment) - See Centrifugal Pump.	115
Pedestal Fan, PSC, TEAO, Yoke Mount.	167	Jet Pump, Two-Compartment, Single Phase, Dripproof, C-Face Footless, 56C/56J	114
Refrigeration Fan - Single Phase	158	Jet Pump, Two-Compartment, Single Phase, Dripproof, Square Flange.	114
Refrigeration Fan - Three Phase (see also Condenser Fan/Heat Pump, Three Phase)	158	Oil Well Pump.	173
Transformer Cooling Fan, TEAO, Single Speed, Rigid Base	159	Spa and Jetted Tub, Single Compartment, Single Phase, Dripproof, Rigid Base, Single and Two Speed	133
Unit Heater Fan, PSC, TEAO, Resilient Base	159	Pool (Above-Ground), Spa and Jetted Tub, Single Compartment, Single Phase, Dripproof, C-Face Footless	134
OEM replacement aftermarket motors	162	Pool (In-Ground), Single Compartment, Single Phase, Dripproof, Square Flange, Single and Two Speed	135
Instant Reversing		Pool (In-Ground), Two-Compartment, Single Phase, Dripproof, Square Flange, Single and Two Speed	136
Single Phase Capacitor Start and PSC, Dripproof and Totally Enclosed.	171	Pool (In-Ground), Single Compartment, Single Phase, Dripproof, C-Face Footless, 56C/56J	137
Kiln Duty	172	Pool (In-Ground), Two-Compartment, Single Phase Dripproof, C-Face Footless, 56C/56J, Single and Two Speed	138
Multi-Speed		Pool (In-Ground), Spa, Three Phase, Dripproof, C-Face Footless, 56C/56J and Square Flange.	139
Two-Speed, One-Winding and Two-Winding, Variable Torque, Three Phase, Dripproof, Rigid Base.	170	Sump Pump, Split Phase, Dripproof	113
Oil Well Pump	173	Washdown - Painted and Stainless Steel	
Pressure Washer		PowerWash™ XT Washdown Duty, Single Phase, C-Face Footless	107
Single Phase, Dripproof, Rigid Base and C-Face Footed (Rigid Base)	174	PowerWash™ Washdown Duty, Single Phase, C-Face Footed (Rigid Base)	107
Single Phase, Totally Enclosed, Rigid Base and C-Face Footed (Rigid Base)	175	PowerWash™ XT Washdown Duty, Three Phase, Rigid Base.	108
Pump motors (Fluid Handling)		PowerWash™ XT Washdown Duty, Three Phase, C-Face Footless	109
Carbonator Pump, Split Phase, Dripproof.	113	PowerWash™ XT Washdown Duty, Three Phase, C-Face Footed (Rigid Base).	110
Centrifugal Pump (Jet Pump), Single Phase, Dripproof, C-Face Footless, 56C/56J	115	PowerWash™ SXT Washdown Duty, Three Phase, Stainless, C-Face Footless.	111
Centrifugal Pump (Jet Pump), Single Phase, Dripproof, C-Face Footed (Rigid Base), 56J	115	PowerWash™ SXT Washdown Duty, Three Phase, Stainless, C-Face Footed (Rigid Base)	111
Centrifugal Pump (Jet Pump), Single Phase, Totally Enclosed, C-Face Footless, 56C/56J	115	PowerWash™ SXT Washdown Duty, Three Phase, Stainless/BISSC, C-Face Footed (Rigid Base).	112
Centrifugal Pump (Jet Pump), Three Phase, Dripproof, C-Face Footless, 56C/56J	116	Woodworking/Power Tool	176
Centrifugal Pump (Jet Pump), Three Phase, Dripproof, C-Face Footed (Rigid Base), 56J	116	50 Hertz	176
Centrifugal Pump (Jet Pump), Three Phase, Totally Enclosed, C-Face Footless, 56C/56J	117	Modifications through MOD Central	177
Centrifugal Pump (Jet Pump), Three Phase, Totally Enclosed, C-Face footed (Removable Base), 56J	117	Accessory Kits	188
Circulator Pump, Single Phase, Dripproof - see also HVAC/Air Moving section.	155	"Specials are our Specialty"	210
Close Coupled Pump, JM, Single Phase, Dripproof, C-Face Footed (Rigid Base)	118	Index	
Close Coupled Pump, JM, Single Phase, Totally Enclosed, C-Face Footed (Rigid Base).	118	Catalog to Model Number.	212
Close Couple Pump, JM, Three Phase, Dripproof, C-Face Footed NEMA Premium® Globetrotter®- NEMA Efficiency	123	Model to Catalog Number.	234
Close Coupled Pump, JM, Three Phase, Dripproof, C-Face Footless (Vertical) and C-Face Footed (Rigid Base)	119	Terms and Conditions of Sale	254
Close Coupled Pump, JM, Three Phase, Totally Enclosed, C-Face Footed (Rigid Base).	125	Warnings and Cautions	256
Close Coupled Pump, JP, Single Phase, Dripproof, C-Face Footed (Rigid Base)	126	EISA - Frequently Asked Questions	257
Close Coupled Pump, JP, Three Phase, Dripproof, C-Face Footless (Vertical) and C-Face Footed (Rigid Base)	127	NEMA MG-1 Table 12-11 EAct Efficiencies	258
		NEMA MG-1 Table 12-12 NEMA Premium® Efficiencies	259
		NEMA Quick Reference Dimensional Chart	260
		Footnotes	Flip Out
		Blue Chip® Product Line Comparison	IBC
		IEC Quick Reference Dimensional Chart	Flip Out

General Information

MARATHON ELECTRIC

Since 1913, Marathon Electric's name has been recognized for engineering excellence, custom-designed products and an extensive product line of industrial quality motors. Available in all popular enclosures from 1/12 HP through 3000 HP and in a variety of mounting configurations, Marathon Electric's unique designs provide more ways in which to add accessories, such as blowers, brakes and encoders, to our motors than anyone else in the motor business. Our state-of-the-art lab facilities are equipped and staffed with the finest resources available to ensure successful utilization of our products. Finally, as the preferred supplier of motors to most of the top drive manufacturers in North America, we have what it takes to be a leader in understanding the interaction of drives as they are applied with AC induction motors.

WEBSITE AND E-COMMERCE

Information can be accessed instantly, any time of the day on ME-business. Marathon customers can sign-up for ME-business by contacting their sales representative.

ME-business can be accessed through: www.marathonelectric.com.

- Stock Availability
- Order Status
- Shipping Information
- Invoice Information
- Product features and performance data



Marathon Electric Nameplate Information - HOW TO READ THE NAMEPLATE

The nameplate is the key to selecting the proper replacement motor.

marathon electric
WAUSAU, WISCONSIN 54401 U.S.A.

XRI
HIGH EFFICIENCY

MARINE DUTY
IEEE45
USCG
IEEE841
NEMA Premium
API RP14F

MODEL AN 256THFNA9026ABL
PART NO 5
TYPE TFS 7
ENCL TEFC 13
MTH/YR MFG. 12/2003 18
ALTITUDE 1000M/3300 FT
HZ 60 21
HP 20 23
F.L.AMPS 24.1 25
PF(COS) ϕ 84.0 27
NOM EFF 93.0 29
SHAFT END BEARING 45BC03XPP30X 30

MTG. F1 3
SER. 6
INS CL F 10
IP 56 15
WT/LBS 412 19
SHAFT END BRG 6309 32
HZ 50
HP 15
F.L.AMPS 21.5
PF(COS) ϕ 82.0
NOM EFF 93.0
OPP. END BEARING 50BC02XPP30X 31

FRAME 256T 4
DUTY CONT 11
MAX AMB ϕ 40°C 12
IC 41 16
CODE G 17
WT/KG 187 20
OPP. 6210 33
VOLTS 460 22
VOLTS 400
KW 15 24
SF 1.25 26
RPM 1775 28
RPM 1475

FOR USE ON PWM VFD 10:1 VT, 20:1 CT, 1.0 SF.

CSA CERTIFIED FOR CLASS I, GROUP A, B, C, D, DIV. 2/ZONE 2 GROUP IIA, IIB, IIC; TEMPERATURE CODE T3 @ 1.0SF OR T2B @ 1.15SF ON SINE-WAVE POWER, OR T2D @ 1.0SF ON PWM TYPE VFD POWER.

CSAT EEV102077
UL E49747
CE
SIF LR21839
CC003A

- CSA Verification Mark - Complies with CSA's Energy Efficiency Verification Service and their Standard C390 - C390 is the Canadian efficiency equivalent of EPAct.
- Underwriters Laboratories, Inc. UL Recognized Component Mark
UL file #
- CE (Conformité Européene) Marking
This mark signifies the motor complies with the European Low Voltage Directive.
- CSA Mark - Certified by the Canadian Standards Association
CSA file #
- CC# - Compliance Certification Number as per assigned by the Department of Energy. Motors meeting EPAct efficiencies or higher will have this number.

Motor Specifications (Example)

Agency Symbols

- MODEL** - The ID number
- DATE CODE** - The month and year manufactured
- MTG.** - Mounting
- FRAME** - The size & mounting
- PART NO.** - Customer part number
- SER.** - Serial number
- TYPE** - Electrical type
- DES.** - Code by NEMA or IEC
- PH** - Electrical phase usually 1 or 3
- INS CL** - Insulation Class
- DUTY** - Time rating under load
- MAX AMB** - The allowable surrounding air temperature
- ENCL** - Enclosure (i.e. TEFC)
- RISE** - The temperature rise over ambient expressed in degrees Celsius when the motor operates at nameplated HP or KW
- IP** - Inherent Protection of the enclosure to solids and liquids as defined by IEC 34-5
- IC** - Inherent Cooling
- CODE** - NEMA locked-rotor KVA
- MTH/YR MFG.** - Month and year motor was manufactured
- WT/LBS** - Motor weight in pounds
- WT/KG** - Motor weight in kilograms
- HZ** - Input frequency of the power supply, usually 50 or 60 HZ
- VOLTS** - Voltage rating of the motor at the operating frequency
- HP** - Rated horsepower the motor will produce
- KW** - Rated output in watts
- F.L. AMPS** - The rated load current expressed in amps at nameplated horsepower with nameplate voltage and frequency
- S.F.** - Percentage of the rated horsepower the motor can safely operate at: Example: 1.15 SF (115% of rated HP)
- PF / COS** - Power Factor / Cosine is the ratio of actual power to the apparent power
- RPM** - Full load speed at rated frequency
- NOM EFF** - Average Efficiency
- SHAFT END BEARING** - Manufacturer drive end bearing number
- OPP. END BEARING** - Manufacturer opposite drive end bearing number
- SHAFT END BRG** - Drive end bearing size
- OPP** - Opposite drive end bearing size



General Information

HOW TO READ A MODEL NUMBER:

Each Marathon Electric motor carries a model number that can be used to define some of the motor's physical and electrical characteristics.

Example (For Fractional): 1PC48C17D2000AP

This is a breakdown of the model on the nameplate:

1	P	C	48	C	17	D	2000	A	P
1	2	3	4	5	6	7	10	11	12

This is a breakdown of the model in the catalog:

48	C	17	D	2000
4	5	6	7	10

Example (For Integral): 2QA215TBDR A7076ALL

This is a breakdown of the model on the nameplate:

2	Q	A	215T	B	D	R	A	7076	AL	L
1	2	3	4	5	7	8	9	10	11	12

This is a breakdown of the model in the catalog:

215T	B	D	R	A	7076
4	5	7	8	9	10

- Date Code** - Year of Manufacture (Not shown in catalog listings.)
- Thermal Protection** (Not shown in catalog listings.)

	UL Recognized Motor Protector Combination	UL Recognized Motor Construction
Automatic Reset	Automatic Reset	Automatic Reset
Q	Yes	Yes
S	No	No
U	No	Yes
W	#	Yes
Manual Reset	Manual Reset	Manual Reset
P	Yes	Yes
Z	No	Yes
X	No	No
None	None	None
V	No	Yes

Motor protector combination is U.L. recognized only if motor is used in direct drive fan duty application, and is under locked rotor condition, or is running under no-load condition.

- Date Code** - Month of Manufacturer (Not shown in catalog listings.)
- NEMA Frame Size** - (Integral motors - T and U designate standard shaft, TS and US designate short shaft)

5. Electrical Type

Single Phase:

- A = Permanent split capacitor
- B = Capacitor start, capacitor run
- C = Capacitor start, induction run
- N = Split phase start, capacitor run
- S = Split phase

Three Phase:

- T = Three phase
- H = Inverter Duty/IEEE841 Inverter Duty
- V = Medium Voltage

DC Power:

- E = Permanent Magnet DC

6. RPM or Speed at 60 Hz (Fractional Only)

- 34 = 2-Pole, 3600 rpm
- 17 = 4-Pole, 1800 rpm
- 11 = 6-Pole, 1200 rpm
- 8 = 8-Pole, 900 rpm

7. Enclosure

- D = Dripproof
- E = Explosion proof, non-ventilated
- F = Totally enclosed, fan cooled
- G = Explosion proof, fan cooled
- O = Open
- P = Partial
- S = Semi-enclosed
- T = Totally enclosed, non-ventilated
- V = Washdown, non-ventilated
- W = Washdown, fan cooled

8. Frame Construction

Integral

- L = Aluminum (Full Frame)
- Y = Aluminum (Full Frame)
- Z = Aluminum (High Mount Down Frame)
- H = Aluminum - Sourced
- R = Rolled Steel (Full Frame)
- W = Rolled Steel (Full Frame)
- X = Rolled Steel (High Mount Down Frame)
- B = Rolled Steel - Sourced
- S = Cast Iron (Full Frame)
- N = Cast Iron (Full Frame)
- P = Cast Iron (High Mount Down Frame)
- C = Cast Iron - Sourced
- D = Stainless Steel

Fractional (where applicable)

- B = Rolled Steel - Sourced
- D = Stainless Steel - Sourced
- U = Frameless - Sourced

9. Style Letter (A, B, C, etc. indicate redesign)

10. Sequence Number

11. Minor Modification Letter(s)

Fractional - 1 letter; Integral - 2 letters

12. Manufacturing Code - A code for the factory where the motor was manufactured.

General Information

HOW TO READ A MODEL NUMBER: Continued

Example ("harmonized" motor design):

A	B	C	D	E	F	G	H	I
5	KH	3	6	K	G	142	-	X

A. Rotating Device

B. Type of Winding

- KH - Split Phase
- KC - Capacitor Start, Induction Run
- K - Polyphase
- KCP - Permanent Split Capacitor
- KCR - Capacitor Start, Capacitor Run

C. Lamination Size

- 3 - 48 frame, 4 - 56 frame

D. Length of Frame

	48 frame	56 frame
2	5.17	5.73
3	5.42	6.63
4	None	None
5	5.80	7.11
6	6.23	None
7	6.63	7.63
8	7.23	8.44
9	Spec.	Spec.

E. Stack Length

A - 5/8"	F - 1-1/4"	L - 1-7/8"	S - 3.0"
B - 3/4"	G - 1-3/8"	M - 2.0"	T - 3-1/4"
C - 7/8"	H - 1-1/2"	N - 2-1/4"	U - 3-1/2"
D - 1.0"	J - 1-5/8"	P - 2-1/2"	W - 4.0"
E - 1-1/8"	K - 1-3/4"	R - 2-3/4"	Q - Spec.

F. Endshield Construction

- G & N - Aluminum
- K - Steel
- C - Cap/Can

G. Sequence Number

H. Current Revision (blank if original)

I. Type of Overload

- X - UL Auto running & locked rotor
- Y - UL Manual running & locked rotor
- S - UL Auto locked rotor
- T - Non-UL Auto running & locked rotor
- U - Non-UL Manual running & locked rotor
- V - Thermostat
- W - UL Motor Parts

ORDERING INFORMATION

When ordering, please include the model number, catalog number, description of the motor, quantity, shipping and billing instructions. For pricing of non-stock motors, or if you need assistance in selecting the proper motor, please contact your nearest Marathon Electric sales representative or local Marathon Electric Distributor. **All prices and data are subject to change without notice.**

CANCELLATIONS AND RETURNS

Stock Product

Stock product can be returned for credit as defined herein. Equipment must be in original packaging, unused in "as shipped" condition and is **limited to products currently maintained in stock inventory**. The quantity returned cannot exceed Marathon Electric's normal stock quantity level. All motors returned must have date codes no older than 18 months from date of manufacture. The minimum restocking charge is 15% of the original net purchase price. Modified and build to order motors cannot be returned for credit. Return freight charges are the responsibility of the customer returning the motor for credit. **No returns will be accepted without prior authorization.**

Non-stock Product Cancellation policy:

Cancellation charges for non-stock orders received and entered will be determined based on the percentage of completion in the engineering and manufacturing process, accounting for all costs plus a reasonable profit. Marathon Electric's determination of the cancellation charges shall be conclusive.

DISCOUNTS AND MULTIPLIERS

Except as noted, all prices in this catalog are list prices. 200 and 575 volt 3 phase ratings utilize the same list price as 230/460 volt. NEMA short shaft (TS) utilize the same list price as standard shaft (T). Contact Marathon Electric for special bearing systems, including all requirements for sleeve or roller bearing. For your discount and multiplier, contact your local Marathon Electric sales representative or local Marathon Electric Distributor.

MODIFICATION/ACCESSORIES

See the Modification/Accessories Sections for more information on modifications to create special motor variations.



General Information

STOCK, NON-STOCK AND BUILD UP MODELS

Standard motors listed in this catalog, as indicated with a check mark (√) next to the catalog number, are normally in stock. There is no minimum order quantity or minimum billing charge associated with stock motors, unless stated otherwise in your quotation or agreement with Marathon Electric.

Production of non-stock catalog models and all build-up models is subject to minimum order quantities or setup charges listed below.

48-140 Frame = 25 piece minimum

180-210 Frames = 5 piece minimum or \$200 set-up/model

250-320 Frames = 5 piece minimum or \$300 set-up/model

Build-up motors must be thoroughly described at time of order, and/or associated with a formal quotation issued by Marathon Electric. **Inclusion of product features for similar motors documented in this catalog should not be assumed.**

SERVICE

For service on any Marathon Electric motor, contact your nearest Marathon Electric Authorized Service Station. For a complete listing of all domestic and foreign service stations, refer to www.marathonelectric.com.

OPERATION AND MAINTENANCE

For information on operation and maintenance, please consult the manual or card shipped with your new motor. Additional copies of "Installation, Operation & Maintenance Instructions" (brochure SB181) are available upon request or through our website, www.marathonelectric.com.

STORAGE PROCEDURES

In the event that long-term storage of motors is required, Marathon Electric recommends the following precautions and procedures. This information is also contained in "Installation, Operation and Maintenance Instructions" (SB181).

A. Keep motors clean

1. Store indoors
2. Keep covered to eliminate airborne dust and dirt.
3. Cover openings for ventilation, conduit connections, etc., to prevent entry of rodents, snakes, birds and insects.

B. Keep motors dry

1. Store in a dry area indoors
2. Temperature swings should be minimal to prevent condensation.
3. Space heaters are recommended to prevent condensation.
4. Treat unpainted flanges, shafts and fittings with a rust inhibitor.
5. Check insulation resistance before putting motor into service.

C. Keep bearings lubricated

1. Once per month, rotate shaft several turns to distribute grease in bearings.
2. If unit has been stored more than one year, add grease before start-up (refer to lubrication procedure).

DIMENSION DRAWINGS

See Marathon Electric's website: www.marathonelectric.com or request certified drawings through your Marathon Electric Sales Engineer, Representative or local Marathon Electric Distributor.

General Information

WARRANTY

Marathon Electric warrants Fractional and Integral motors to be free from defects in materials and workmanship and to conform to Marathon's written specifications.

Motor Type	Warranty Period from Date of Installation*	Warranty Period from Date of Manufacture*
Standard Warranty for any product not shown below	12	18
Medium Voltage	12	18
EPA compliant (aluminum, steel & cast iron frame)	24	30
Blue Chip Severe Duty Explosion Proof	24	30
Blue Max®, Black Max®, & microMax™ Inverter Duty	36	42
All NEMA Premium® incl. ODP, Blue Chip, Severe Duty, Explosion Proof, etc.	36	42
U-Frame Automotive Duty	60	66
Blue Chip IEEE-841	60	66

* Warranty period shown is in months, and is valid for whichever period expires first.

Note: Brake discs are considered a normal maintenance item and are not covered under warranty.

For more information, on Marathon Electric's warranty policy, refer to the "Terms and Conditions of Sale" (MPN411) in the back of this catalog.

SUBMITTAL DATA

Mechanical and electrical submittal data is available on many stock catalog motors through our website www.marathonelectric.com by following the three steps listed on the next page. All other submittal data is available upon request when accompanied by a purchase order for the specified motor, **subject to the following additional charges**

SUBMITTAL CHARGE SCHEDULE

TYPE	ELEMENTS	NET/EA
BASIC (.PDF format)	Nameplate data	No-Charge
	Motor characteristics	
	Performance data	
	Outline drawing	
	External connection diagram	
	Add for .dxf or .dwg format	\$25
BASIC-PLUS (.pdf format)	All "BASIC" elements, tailored to specific order.	\$75
	"Cut sheets" of installed accessories	
	Add for .dxf or .dwg format	\$25
	Speed/Torque curve	\$50
	Torque capability curve	\$50
ADDITIONAL ITEMS (.pdf formats)	Commercial (end of line) test results (not available for West Plains motors)*	\$50
	Certificate of conformance	\$100
	Thermal damage curve (48-326T frame)	\$500 + cost of additional motor
	Thermal damage curve (364T-6805 frame)	\$1500 +cost of additional motor
* Does not imply retesting		

General Information

1. From our homepage, click on the Motors link. From the Motors page, enter in the Marathon Catalog number or Model number.

Then click on Model number in results window.

(Note: If you already have a Marathon Electric motor and are looking for the performance data, make sure the model number off the nameplate is what you use for your search. Ex. 056H17T5301).



2. The Motor Model Details page will appear. You will be able to print dimensional drawings and connection diagrams in PDF format for the motors. Under the Technical Data section, click on the link, [Certification Data Sheet](#).

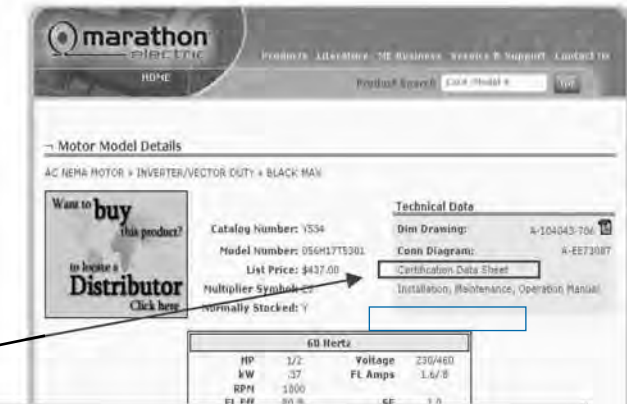

3. Your results will look similar to the example shown to the right for Marathon's 1/2 HP, Black Max® motor, model # 056H17T5301. It's that easy!

HP	FL KVA	FL KW	FL AMP	FL TORQUE	FL SPEED	FL EFF	FL COS φ	FL INERTIA	FL WEIGHT
1/2	0.37	0.27	0.85	1.5	1800	80.0	0.85	0.0001	1.5

Application Information

AGENCY LISTINGS

UL and CSA

Marathon Electric's Fire Pump and Explosion Proof motors are UL Listed. Other motor types are UL Recognized, including models with inherent overheating protection as noted (i.e. thermally protected models). Marathon motors are also CSA Certified for both explosion proof and non-explosion proof enclosures.

AC Motors

Non-Explosion Proof	UL File No.	CSA File No.
NEMA 48-449 Frame	E49747	LR2025
All 5K type models numbers	E46035	MC236833
NEMA 500 and 5000 Frame	—	LR2025*
IEC 63-90 Frame	E49747	LR2025
IEC 100-280 Frame	E49747	LR2025†
Thermally Protected motors	E6312	LR2025
Thermally Protected 5K motors	E14133	MC236833
Insulation Systems	E37900	LR2025
* Does not include coverage for use with VFD		
† Domestic product only		
Explosion Proof	UL File No.	CSA File No.
NEMA 56-326 Frame	E12044	LR47504
NEMA 364-449 Frame	E12044	LR21839
Fire Pump Motors	UL File No.	CSA File No.
NEMA 143-510	EX5190	LR2025
Class I, Division 2/Zone 2	UL File No.	CSA File No.
NEMA 48-449, 5000 Frame	—	LR21839
European ATEX Zone 2	Intertek Certificate No.	
NEMA 143-449, IEC 112-280	ITS06ATEX45370	

PMDC Motors

Non-Explosion Proof	UL File No.	CSA File No.
NEMA 56-145	E49747	E49747

CE (Conformity Europeenne)

CE marking on the nameplates of Marathon Electric motors is available upon request for most motors rated 600V or less. We do not apply the CE Marking to explosion proof motors. The European "Low Voltage" Directive applies to electric motors. Contact a factory representative for details. Non-explosion proof microMAX™, BlackMax® and BlueMax® (TENV and TEFC) standard (catalog) models have the CE Mark on the nameplate.

ATEX Directive (ATmospheres EXplosibles)

Mandatory by law, the European Union (EU) Directive 94/9/EC requires that electric motors for use in explosive atmospheres carry the CE mark, notified body identifier, Ex symbol, equipment group and category, plus the date code. See "European Installations" for additional details, located on the next page.

NEMA (National Electrical Manufacturers Ass'n)

Marathon Electric motors are manufactured in accordance with all applicable areas of NEMA standards in MG1-2006. When applied in accordance with the "Guidelines for Application of Three Phase Motors on Variable Frequency Drives", **Marathon Electric motors are in full compliance with NEMA MG1-2006, Part 31, Section 4.4.2**, as pertaining to voltage spikes. 460 volt motors must withstand voltage

spikes of up to 1426 volts; 575 volt motors must withstand spikes up to 1788 volts. See "Insulation Systems" for additional detail on this subject.

Commitment to RoHS and WEEE European Directives

European Directive 2002/95/EC "Restriction of Use of Certain Hazardous Substances" (RoHS) and Directive 2002/96/EC "Directives on Waste Electrical and Electronic Equipment" (WEEE) were enacted to control the amount of certain hazardous substances contained in products shipped into the E.U. Restricted substances include lead, mercury, cadmium, hexavalent chromium, polybrominated biphenyls and polybrominated dipheynl ethers.

The scope of products covered, affecting motors, is:

- Large household appliances
- Small household appliances
- IT and telecommunications equipment
- Consumer equipment
- Electrical and electronic tools (except large scale stationary and industrial tools)
- Toys, leisure and sports equipment
- Automatic dispensers

The Directives do not currently apply to medical devices, monitoring and control instruments, spare parts for the repair or reuse of electrical and electronic equipment placed on the market before July 1, 2006, and most military and state security equipment.

Regal Beloit Corporation worked closely with suppliers to assure that product falling within the scope of these Directives meets the specified levels of these substances. The Directives took affect July 1st, 2006 however many products were converted in May and June. The products converted are motors in NEMA frame size 145 and below, both AC and DC motors with the following exceptions:

- Sleeve bearing motors
- Brake motors in 56-145 frame **will have to be ordered specifically as RoHS compliant.**
- **Some motors with specialty electro-mechanical components.**

BEARINGS

FRAME SIZE	STANDARD TYPE	COMMENTS
48	Shield Ball	
56 - 145T	Sealed Ball	
182 - 444T	Double Shield Ball	
284 - 449TS	Single Shield Ball	
445T - 6805	Double Shield Ball	Direct - coupled loads
445T - 6805	Roller (DE)/Ball	Belted loads

* **Beltting data must be provided on all belted applications**

Standard horizontal motors can be mounted in a vertical shaft down orientation (except brakemotors). Contact a factory representative for shaft up mounting arrangements.

Motors for use in vertical shaft up or shaft down configurations must be reviewed by Engineering before ordering.

Continued on next page.



Application Information

Marathon Electric motors employ the use of Mobil POLYREX[®] EM grease, a specially formulated bearing grease designed for electric motors. POLYREX[®] EM provides superior lubricity, durability and resists corrosion, rust and washout. POLYREX[®] EM is a registered trademark of Mobil Corporation.

Maximum safe mechanical speed capability is a function of bearing size, type and grease selection, as well as rotor balance specifications. Consult the "Maximum Safe Mechanical Speed Limits" chart in the "Overspeed Capability" section.

Note that these values do not imply maximum constant horsepower RPM.

EFFICIENCY

The efficiency of a motor is the ratio of its useful power output to its total power input and is usually expressed in a percentage. Marathon Electric offers standard, high efficient EPAct, and **NEMA Premium[®]** efficient (XRI) ratings. Standard efficiency motors may only be used on applications that are exempt from legislated efficiencies. The high efficient motor line is in compliance with the Energy Policy Act of 1992 (EPAct) and/or Canadian efficiencies as set by NRCAN. The Energy Independence and Security Act of 2007 (**EISA07**) will become law on December 19, 2010, requiring current EPAct-compliant motors to meet NEMA Premium[®] efficiencies, and most EPAct-exempt motors to meet EPAct levels. XRI Premium efficient motors in this catalog meet NEMA Premium[®] unless otherwise noted.

The XRI[®] line is a premium efficiency line, which exceeds mandated efficiencies of EPAct and /or NRCAN. Unless otherwise noted, XRI[®] premium efficient motors in this catalog meet NEMA Premium[®] the newly promoted efficiency levels by NEMA and the Consortium for Energy Efficiency (CEE).

ELECTRICAL TYPE/STARTING METHOD

Motors in this catalog are capacitor start, split phase, permanent split capacitor, or three phase. Capacitor Start motors have high starting torque, high breakdown torque, and relatively low starting current. Split phase motors have medium starting torque and medium starting current. Permanent split capacitor motors have low starting torque and low starting current. Three phase motors have high starting, extra breakdown torque, and typically very low starting current. Single phase motors cannot be applied on variable frequency drives with three phase output.

ENCLOSURE AND METHOD OF COOLING

Marathon Electric motors are available in various enclosures; Dripproof (DP), Dripproof Force Ventilated (DPFV), Totally Enclosed Fan Cooled (TEFC), Totally Enclosed Non-Ventilated (TENV), Totally Enclosed (TEAO) and Totally Enclosed Blower Cooled (TEBC). Application conditions will determine the type of motor enclosure required.

Dripproof motors have open enclosures and are suitable for indoor use and in relatively clean atmospheres. Dripproof motors have ventilating openings constructed so that drops of liquid or solid particles falling on the machine at an angle of not greater than 15 degrees from the vertical cannot enter the machine.

Totally enclosed motors are suitable for use in humid environments or dusty, contaminated atmospheres. Totally enclosed non-ventilated motors are NOT cooled by external means. Totally enclosed fan cooled motors are cooled by external means that are part of the motor but not in the internal workings of the motor. Totally enclosed air over motors are sufficiently cooled by external means, provided by the customer.

HAZARDOUS DUTY™

Hazardous Duty™ motors are totally enclosed (fan cooled or non-ventilated) motors designed for applications in hazardous atmospheres containing explosive gases and/or combustible dusts.

North American installations

North American standards for electric motors generally fall into one of two divisions. Division 1 Explosion Proof motors are UL Listed in accordance with NFPA Class I (Flammable Gases) or Class II (Combustible Dusts) and Groups (gases or dusts), depending upon the atmosphere. Division 2 motors are CSA Certified and are marked similarly to Division 1 equipment. Inverter Duty motors through 449T frames are CSA Certified for use in Division 2 locations.

European installations

Motors for hazardous locations in Europe must meet a different set of standards and require different markings than those of North America. CENELEC sets the standards for equipment in hazardous locations for Europe. Motors for use in explosive atmospheres in Europe are often referred to as flameproof (Zone 1) or non-sparking (Zone 2) motors. These motors must comply with the ATEX Directive. The ATEX Directive covers all electrical equipment used in explosive atmospheres. To ensure compliance with the Directive, equipment must meet the essential ATEX requirements and carry the CE mark on the nameplate. Other information required on the nameplate includes the Ex symbol, group & category, Ex protection method, gas group, and temperature code, example (Ex) II 3 G Ex nA IIC T3).

The tables on the next page describe Marathon Electric's capabilities by Area Classification and by Temperature Code.

IEC DEGREES OF PROTECTION vs. MARATHON ELECTRIC'S STANDARD CONSTRUCTION

The enclosure terminology for an IEC motor is a combination of the IP (Ingress Protection) and IC (Inherent Cooling) codes. Each number in the IP code stands for a different degree of protection.

- IP12 - Dripproof
- IP22 - Dripproof with screens, or die cast aluminum bracket
- IP43 - Totally Enclosed
- IP54 - Totally Enclosed Severe Duty
- IP55 - Totally Enclosed Severe Duty with V-Ring Shaft seals, and/or "Smart Ring" rotating shaft seal and Neoprene gaskets
- IP56 - Totally Enclosed Severe Duty with rotating Shaft seals (eg. Inpro/Seal[®] VBX bearing isolator) and Neoprene gaskets

Application Information

Marathon Electric Hazardous Duty Motor Area Classification Chart

Class I Area Classification (Flammable Gases, Vapors or Mists)				Class II Area Classification (Combustible Dusts)			
North America		Europe - ATEX (Category G - Gases)		North America		Europe - ATEX (Category D - Dusts)	
Division 1 Explosion Proof	Division 2 TEFC & TENV	Zone1 Flameproof	Zone 2 Non-Sparking	Division 1 Explosion Proof	Division2	Zone 21 Flameproof	Zone 22 Non-Sparking
Group A ^①	Group A	Contact Marathon Electric for ATEX Zone 1 capabilities	Group IIC, Category G	-	-	-	-
Group B ^②	Group B		Group IIC, Category G	-	-	-	-
Group C	Group C		Group IIB, Category G	-	-	-	-
Group D	Group D		Group IIA, Category G	-	-	-	-
-	-	-	-	Group E	-	Category D	Category D
-	-	-	-	Group F	Group F ^①	Category D	Category D
-	-	-	-	Group G	Group G ^①	Category D	Category D

- Group is not applicable to that Division or Zone, or is not defined.

① Group is not available from Marathon Electric.

② Contact factory representative for availability.

APPLICATION INFORMATION

Marathon Electric Hazardous Duty Motor Temperature Code Chart

	TEMPERATURE CODES		Division 1 Explosion Proof/Zone 1 Flameproof		Division 2/Zone 2 Non-Sparking
			Class I Area Classification (Flammable Gases, Vapors or Mists)	Class II Area Classification* (Combustible Dusts)	Class I Area Classification (Flammable Gases, Vapors or Mists)
Temp.	UL/CSA	ATEX	Division 1/Zone 1	Division 1/Zone 21	Division 2/Zone 2
280°C	T2A	T2(280)	Explosion Proof - Class I, Group D (Group C as noted)		
260°C	T2B	T2(260)			XRI® Severe Duty & IEEE-841 @ 1.15 S.F., Class I, Groups A,B,C,D (Sine wave power)
215°C	T2D	T2(215)			Available through Marathon's Mod Central on Totally Enclosed EPAct, XRI®, XRI® Severe Duty or IEEE-841 @ 1.0 S.F. on PWM VFD, Class I, Groups A, B, C, D
200°C	T3	T3			Available through Marathon's Mod Central on Totally Enclosed EPAct, XRI®, XRI® Severe Duty or IEEE-841 @ 1.0 S.F., Sine wave power Class I, Groups A, B, C, D
165°C	T3B	T3(165)	Explosion Proof - Class I, Group D (Group C as noted), Sine wave or PWM power	Explosion Proof - Class II, Groups F & G, Sine wave or PWM power	
160°C	T3C	T3(160)	Available through Marathon's Mod Central on Explosion Proof - Class I, Group C & D @ 1.0 S.F. - Contact Factory	Available through Marathon's Mod Central on Explosion Proof - Class II, Group F & G @ 1.0 S.F. - Contact Factory	
135°C	T4	T4	ATEX compliant motors	ATEX compliant motors	

Division I & II ambient range is -25°C to +40°C

ATEX ambient range is -20°C to +40°C

Consult Marathon Electric for higher ambients



Application Information

INSULATION SYSTEMS

Class B – General Purpose motors that employ Class B insulation systems have a total temperature rating of 130°C and maximum allowable temperature rise of 80°C at 1.0 S.F.

Class F – Motors with a Class F system have a total temperature rating of 155°C, with a maximum temperature rise of 105°C at 1.0 S.F. Many Marathon Electric designs utilize a Class F system but limit temperature rise to no higher than “B” rise, providing thermal “headroom” for longer insulation life.

Class H – Class H insulated motors have a total temperature rating of 180°C and maximum allowable temperature rise of 125°C. All Marathon Electric motors that employ a Class H system are designed to operate between “B” and “F” rise, giving the user a generous thermal cushion.

“CR200” – Corona Resistant, 200° rated magnet wire is utilized in numerous general purpose and inverter duty motor designs to extend insulation life under the rigors of steep fronted voltage spikes, common with today’s IGBT inverters. Refer to page 14 for product lines that employ the use of CR200 magnet wire.

Motors with the CR200 insulation system can be operated at up to 475 feet from the drive on 460 volt systems, at 3 KHz carrier frequency. For other voltages and/or carrier frequency combinations, contact a factory representative.

MAX GUARD® – All Black Max®, Blue Max®, Blue Chip®, XRI® Severe Duty and XRI®-841 (IEEE841) motors feature the MAX GUARD® insulation system, either in conjunction with Class F or Class H materials. Combining corona-resistant magnet wire (CR200) with our patented “low stress” winding configuration and uncompromising quality standards, MAX GUARD® delivers long, dependable motor life under the adverse thermal and dielectric stresses imposed by IGBT-based variable frequency drives. **MAX GUARD® surpasses the requirements of NEMA MG1-2006, Part 31, Section 4.4.2.**

460 Volt (or lower) motors equipped with MAX GUARD® can be operated at any distance from the drive and at any carrier frequency. 575 Volt motors can be operated at up to 650 feet cable length at 3 KHz.

MOUNTING

Most Marathon Electric motors are designed for horizontal mounting (shaft parallel with ground), unless designed otherwise, such as Vertical P Base motors. As a general rule, a horizontal motor can also be mounted in a vertical shaft down orientation. Horizontal motors should never be mounted in a vertical shaft up orientation without consulting your application engineer, as this practice can cause damage to the motor, which is not covered under warranty. Brakemotors should not be mounted vertically (up or down), unless the brake has been specifically designed for such.

NEMA SERVICE FACTOR RATINGS

The table below lists the NEMA service factors for single phase, dripproof motors. Totally enclosed and explosion proof motors have 1.0 service factor except where noted.

Single Phase

NEMA SERVICE FACTOR @ RPM LISTED

HP	3600	1800	1200	900
1/12	1.4	1.4	1.4	1.4
1/8	1.4	1.4	1.4	1.4
1/6	1.35	1.35	1.35	1.35
1/4	1.35	1.35	1.35	1.35
1/3	1.35	1.35	1.35	1.35
1/2	1.25	1.25	1.25	1.15
3/4	1.25	1.25	1.15	1.15
1	1.25	1.15	1.15	1.15
1.5 & Up	1.15	1.15	1.15	1.15

OVERLOAD PROTECTION

There are four choices in protection: manual (inherent type), automatic (inherent type), thermostats, and none. A manual overload must be physically reset to restart the motor. An automatic thermal overload will stop the motor when it is overloaded or overheated and restart it after the motor has cooled down. None means the motor has no protection. Thermostats are embedded in the winding and connected to the motor starter control circuit. Marathon Electric’s standards are normally closed thermostats, one per phase.



A motor with an automatic reset protector must not be used where automatic restarting (after motor cool-down) would endanger personnel or equipment. Such applications should use a manual reset protector.

PHASE/POWER SUPPLY

Is the power supply three phase or single phase? Most home and farm applications require single phase motors, while most factories, large commercial and industrial users require three phase motors. Single phase motors can be used on three phase systems. Three phase motors, however, cannot be operated from single phase systems. Motor damage will result.

ROTATION

Most motors in this catalog are reversible by electrical reconnection or by physical orientation. Marathon Electric’s standard rotation from the factory for single phase motors is counterclockwise, when viewing the opposite shaft end of the motor

SPEED/RPM

3600, 1800, and 1200 are the most common 60 HZ synchronous speeds with full load speed equivalents of 3450, 1725, and 1150.

Application Information

TERMINOLOGY

Ambient Temperature – Temperature of the medium, such as air, water or earth, into which the heat of the equipment is dissipated.

Ampere (AMP) - A measure of the rate of current through the motor.

Base Speed – Nameplate rating where the motor will develop rated HP at rated load and voltage. With AC systems, it is commonly the point where 60 Hz is applied to the induction motor.

Breakaway Torque – The torque required to start a machine from standstill.

Breakdown Torque (BDT) – The maximum torque that an AC motor will develop with rated voltage applied at rated frequency while rotating.

Cogging – A condition in which a motor does not rotate smoothly but “steps” or “jerks” from one position to another during shaft revolution. Cogging is most pronounced at low motor speeds and can cause objectionable vibrations in the driven machine.

Continuous Duty – The continuous rating is the maximum constant load that can be carried continuously without exceeding established temperature rise limitations under prescribed conditions of load and within the limitations of established standards.

Definite Purpose Motor – Any motor design, listed and offered in standard ratings with standard operating characteristics and mechanical construction, for use under service conditions other than usual or for use on a particular type of application (NEMA).

Duty Cycle – The relationship between the operating and resting times or repeatable operation at different loads and/or speeds.

Efficiency – Ratio of power output to power input indicated as a percentage. In motors, it is the effectiveness with which a motor converts electrical power into mechanical power.

Frequency – Number of cycles per second of alternating current 60HZ used primarily in the United States, 50HZ normally used overseas.

Full Load Torque (FLT) – The torque necessary to produce rated horsepower at full load speed.

General Purpose Motor – This motor has a continuous duty rating and NEMA A or B design, listed and offered in standard ratings with standard operating characteristics and mechanical construction for use under usual service conditions without restriction to a particular application or type of application (NEMA).

Inertia – A measure of a body’s resistance to changes in velocity, whether the body is at rest or moving at a constant velocity. The velocity can be either linear or rotational. The moment of inertia (WK^2) is the product of the weight (W) of an object and the square of the radius of gyration (K^2). The radius of gyration is a measure of how the mass of the object is distributed about the axis of rotation. WK^2 is usually expressed in units of $lb-ft^2$.

Intermittent Duty – A motor that never reaches equilibrium temperature, but is permitted to cool down (to ambient temperature) between operations. For example, a crane, hoist or machine tool motor is often rated for 15, 30 or 60 minute duty.

Load Sharing – An application condition in which two or more similar-sized AC Induction motors are mechanically connected to each other and powered from the same inverter. Optimum load sharing is achieved with higher slip (NEMA Design B or C) motors.

Locked Rotor Current (LRA) – Steady state current taken from the line with the rotor at standstill, at rated voltage and frequency. This is the current when starting the motor and load across the line.

Locked Rotor Torque (LRT) – The minimum torque that a motor will develop at rest for all angular positions of the rotor, with rated voltage applied at rated frequency.

No Load (Conditions) – The state of a machine rotating at normal speed under rated conditions, but when no output is required from it.

Power Factor – Power factor is the ratio of real power (kW) to total kVA, or the ratio of actual power (W) to apparent power (volt-amperes).

Reactance – The opposition to the flow of current made by an induction coil or a capacitor. Performance data expresses stator reactance as X1 and rotor reactance as X2.

Resistance – The opposition to voltage or current in an electrical circuit. Performance data expresses stator resistance as R1 and rotor resistance as R2.

Rotor – The rotating member of a machine with a shaft.

Service Factor (SF) – When used on a motor nameplate, a number which indicates how much above the nameplate rating a motor can be loaded intermittently without causing serious degradation (i.e. a motor with 1.15 SF can produce 15% greater torque than one with 1.0 SF, within temperature constraints).



Application Information

TERMINOLOGY

Shock Load – The load seen by a clutch, brake or motor in a system that transmits high peak loads. This type of load is present in crushers, separators, grinders, conveyors, winches and cranes.

Slip – The difference between the speed of the rotating magnetic field (synchronous speed) and mechanical rotational speed (rotor speed) of AC induction motors. Usually expressed as a percentage of synchronous speed.

Special Purpose Motor – A motor with special operating characteristics, special mechanical construction, or both, designed for a particular application and not falling within the definition of a general purpose or definite purpose motor (NEMA).

Speed Range – The minimum and maximum speeds at which a motor must operate under constant or variable torque load conditions. A 50:1 speed range for a motor with top speed of 1800 RPM means the motor must operate as low as 36 RPM and still operate within specifications.

Starting Torque – The torque exerted by the motor during the starting period.

Stator – The stationary portion of the magnetic circuit and the associated windings and leads of a rotating machine.

Synchronous Speed – The speed of an AC induction motor's rotating magnetic field. It is determined by the frequency applied to the stator and the number of magnetic poles present in each phase of the stator windings. Mathematically, it is expressed as Sync Speed (RPM) = 120 x Applied Frequency (Hz)/Number of Poles per phase.

Torque – A turning force applied to a shaft, tending to cause rotation. Torque is normally measured in "pound-feet" and is equal to the force applied times the radius through which it acts.

Torque-to-Inertia Ratio – The rated motor torque divided by its rotor inertia. Helps determine a motor's ability to accelerate loads and/or respond to commands from a drive to change speed or direction.

FORMULAS & CONVERSION FACTORS

$$\text{Torque (lb-ft)} = \frac{\text{HP} \times 5250}{\text{RPM}}$$

$$\text{HP} = \frac{\text{Torque (lb-ft)} \times \text{RPM}}{5250}$$

$$\text{Synchronous RPM} = \frac{120 \times \text{Frequency}}{\# \text{ Poles}}$$

$$\text{Ohms} = \text{Volts} / \text{Amperes} (R = E/I)$$

$$\text{Amperes} = \text{Volts} / \text{Ohms} (I = E/R)$$

$$\text{Volts} = \text{Amperes} \times \text{Ohms} (E = IR)$$

$$\text{Newton-meters (torque)} = 1.3558 \times \text{lb-ft}$$

$$\text{Pound-feet (torque)} = .7376 \times \text{Newton-meters}$$

$$\text{Horsepower} = 746 \text{ watts} (.746 \text{ KW})$$

$$\text{Kilowatts (KW)} = 1.341 \times \text{Horsepower}$$

$$\text{Temperature (}^\circ\text{ Celsius)} = 5/9 \times (^\circ\text{F} - 32)$$

$$\text{Temperature (}^\circ\text{ Fahrenheit)} = (9/5 \times ^\circ\text{C}) + 32$$

Variable Speed Operation

Guidelines for Application of General Purpose, Three Phase, Single Speed Motors on Variable Frequency Drives Meets NEMA MG1-2006 Part 30 and Part 31 Section 4.4.2 Unless stated otherwise, motor nameplates do NOT include listed speed range.

ENCLOSURE	EFFICIENCY	VARIABLE TORQUE	CONSTANT TORQUE								
		ALL FRAMES	56	143-215		254-286		324-365		404-449	
NEMA Motors		ALL POLES	ALL POLES	2-Pole	4&6 Pole	2-Pole	4&6 Pole	2-Pole	4&6 Pole	2-Pole	4&6 Pole
ODP	Standard (EPAAct exempt)	10:1	2:1	2:1	2:1	Contact Engineering					
	EPAAct compliant	10:1	N/A	2:1	2:1	2:1	2:1	Contact Engineering			
	NEMA Premium (XRI)	10:1	N/A	10:1	10:1	10:1	10:1	10:1	10:1	2:1	2:1
TEFC	Standard (EPAAct exempt)	10:1	2:1	2:1	2:1	Contact Engineering					
	EPAAct compliant	10:1	N/A	2:1	10:1	2:1	10:1	2:1	2:1	2:1	2:1
	NEMA Premium (XRI)	10:1	N/A	2:1	20:1	2:1	20:1	2:1	20:1 (1)	2:1	20:1 (1)
TENV	EPAAct compliant	10:1	N/A	1000:1	1000:1	1000:1	1000:1	1000:1	1000:1	1000:1	1000:1
	NEMA Premium (XRI)	10:1	1000:1	1000:1	1000:1	1000:1	1000:1	1000:1	1000:1	1000:1	1000:1
Washdown TEFC	Standard (EPAAct exempt)	10:1	10:1 (2)	10:1 (2)	10:1 (2)	N/A	N/A	N/A	N/A	N/A	N/A
	EPAAct compliant	10:1	N/A	10:1 (2)	10:1 (2)	N/A	N/A	N/A	N/A	N/A	N/A
Washdown TENV	Standard (EPAAct exempt)	10:1	1000:1	1000:1	1000:1	N/A	N/A	N/A	N/A	N/A	N/A
	EPAAct compliant	10:1	N/A	1000:1	1000:1	N/A	N/A	N/A	N/A	N/A	N/A
Explosion Proof	All efficiency levels	Explosion Proof motors must be properly nameplated with inverter duty information prior to use on VFD. See Marathon catalog pages for specific rating capabilities. Motors with automatic overload protectors cannot be used on VFDs.									
IEC Motors		ALL FRAMES	63-90	100-225							
All Enclosures	All efficiency levels	10:1	20:1	Up to 20:1							

- Notes: (1) 324-449T, 4 & 6 Pole XRI motors are rated for 20:1 C.T. with fan modification; otherwise rated for 2:1 C.T. continuous duty, or 20:1 C.T. 60 minute duty at lowest RPM.
 (2) Washdown TEFC motors are rated for 10:1 C.T. 60 minute duty or 2:1 C.T. continuous duty at lowest RPM.
 Model numbers beginning with 5K are not suitable for use with Variable Frequency Drives.

Application Notes

Bearing currents	Marathon Electric recommends that any motors used with Variable Frequency Drives be equipped with suitable means to protect the motor bearings from shaft currents caused by common mode voltages inherent with operation on a non-sinusoidal power supply. Marathon Electric offers several options for motors in non-classified (non-hazardous) locations, including ground brushes, insulated bearings and non-contact shaft grounding rings. For more information on ground brushes and bearing currents, see the VARIABLE SPEED OPERATION section. For installation cost and available options, see the MOD CENTRAL section.
Restricted use	DO NOT APPLY THE FOLLOWING MOTORS ON VARIABLE FREQUENCY DRIVES: Single Phase motors, Motors with inherent overload protection, Multi-Speed motors, Motors with 1.0 Service Factor on sine wave power. Fire Pump motors should not be used with variable frequency power supplies, due to the critical nature of these applications.
Hazardous Locations	Consult with Marathon Electric when applying motors and drives into Hazardous Locations, either Division/Zone 1 or Division/Zone 2 areas. UL and CSA policies prohibit the installation of bearing protection devices, such as shaft grounding brushes, rings or insulated bearings on motors in Hazardous Locations.

Maximum Cable Lengths from the Motor to Drive

PRODUCT DESCRIPTION	3 kHz CARRIER FREQUENCY (PHASE TO PHASE)*		
	230 VOLT	460 VOLT	575 VOLT
56-326 NEMA, 100-225 IEC Frames	600 ft.	125 ft.	40 ft.
364-5013 NEMA, 250-315 IEC Frames	1000 ft.	225 ft.	60 ft.
Motors with CR ²⁰⁰ Corona Resistant Magnet Wire	1500 ft.	475 ft.	140 ft.
Motors with MAX GUARD [®] insulation system	Unlimited	Unlimited	650 ft.
Form-wound low voltage motors	Unlimited	Unlimited	650 ft.

* Higher carrier frequencies require shorter cable length to obtain normal (50Khrs) insulation life.

Standard Motor Insulation Systems

CR200 CORONA-RESISTANT MAGNET WIRE	Max Guard*
microMAX inverter duty	Black Max Vector Duty
"4 - in - 1" Three Phase, C-Face with Removable Base	Blue Max Vector Duty
Standard Three Phase stock Brakemotors	Three Phase PowerWash XT and SXT washdown
Blue Chip Severe Duty Explosion Proof,	Blue Chip XRI Severe Duty
EPAAct Efficiency	Blue Chip XRI-841 (IEEE841 compliant)
	Automotive Duty "T" Frame
	Blue Chip Explosion Proof, XRI Premium Efficiency
	Globetrotter IEC Metric motors



Variable Speed Operation

VARIABLE SPEED INFORMATION

Marathon Electric Vector-Duty and Inverter-Duty motors, unless otherwise stated, are rated for continuous operation in a 40°C ambient and for altitudes up to 3300 feet (1000 meters) above sea level. Special application considerations, such as high or low ambient, intermittent ratings, high altitude, duty cycle rated, extended constant horsepower range, special base speed, voltage or frequency, or any other special requirements, should be reviewed by a factory representative.

It is the responsibility of the startup personnel during commissioning of the VFD/motor system to properly tune the drive to the motor for the specific application. The correct voltage boost and volts/hertz settings are application dependent and unique to each motor design. Procedures for these adjustments should be in your VFD user manual. Many Vector Duty and Inverter Duty motors in this catalog are equipped with thermostats; warranty coverage may be denied if they are not properly utilized.

 **WARNING** *Power factor correction capacitors should never be installed between the drive and the motor.*



INVERTER DUTY OR INVERTER RATED

“Inverter Duty” (often called “Inverter Rated”) motors are suitable for use with Variable Frequency Drives, as long as operation is within the application guidelines published in this catalog. In general, Marathon Electric’s three phase, general purpose, NEMA Design B motors are considered “Inverter Duty”, and meet or exceed the requirements of NEMA MG1, Part 30. As required under Federal law, these motors comply with EPAAct efficiencies when operating from utility power.

Many of Marathon’s motor product lines have been enhanced to facilitate reliable operation on today’s variable speed drives, including wider constant torque speed range (up to 20:1) and improved insulation systems that withstand voltage spikes common with variable frequency operation.

Inverter Duty (Rated) motors are most often used in 10:1 speed range, variable torque or constant torque applications. A vector control is usually required for operation beyond 10:1 CT.

Refer to “Guidelines for Application of General Purpose, Single Speed Three Phase Motors on Variable Frequency Drives” in this section of this catalog for the allowable speed range and cable length restrictions (from VFD to motor). Additional detail regarding a specific product’s capabilities is available on its catalog page, or by consulting your application engineer.

VECTOR DUTY – “Vector Duty” describes a class of motors that are used in conjunction with Open- (without encoder) or Closed-Loop (with encoder) Vector controls, that provide enhanced performance under low speed operating conditions, or in cases where torque (rather than speed) must be controlled. “Vector Duty” motors can be applied to Volts/Hertz (scalar) drives, as well.

Marathon Electric’s “MAX” family, consisting of Blue Max®, Black Max® and microMAX™ motors, have been specifically designed for optimal operation on vector or volts/hertz controls. These motors feature a wide constant torque (up to 2000:1) and/or constant horsepower (up to 4:1) speed range and are performance-matched to all current technology IGBT drives. Vector Duty motors meet or exceed the requirements of NEMA MG1, Part 31, and are equipped with an enhanced insulation system (MAX GUARD® or CR²⁰⁰) to provide many years of trouble-free service. Consult the catalog page for each product’s capabilities and features. As these motors are specifically designed for operation through an inverter, they are exempt from EPAAct legislation. Model numbers contain the letter “H” in the “Electrical Type” field.

VARIABLE TORQUE LOADS – Applications include fans, blowers and centrifugal pumps. Torque varies as the square of the speed, and horsepower as the cube of the speed. Operation below base speed significantly lightens the load on the motor. While most variable torque applications do not require the motor to operate below half speed, the motor is fully capable of operation to zero speed. Operation above base speed significantly adds to the load on the motor; therefore, a factory representative must review applications requiring variable torque above base speed. Refer to the application chart found on page 14 for use of general purpose three phase motors on variable frequency drives. Marathon’s microMAX™, Black Max® or Blue Max® motors are not necessarily required for operation of variable torque loads. A bypass circuit is often employed in Variable Torque applications. If this device is intended to be used, selection of a NEMA Design B motor is recommended, to withstand the inrush current during across-the-line starting.

CONSTANT TORQUE LOADS – Applications include conveyors, elevators, hoists, extruders, positive displacement pumps, mixers and converting equipment. Torque remains constant throughout the range of operation, and extra care should be taken in the proper application of motors, especially at very low speeds. Most constant torque applications don’t require operation below 10:1 (i.e. 6 Hz operation on a 60 Hz motor), but an increasing number of applications historically reserved for servo and/or stepper systems are being served with motors capable of operation beyond 20:1, up to 2000:1 (zero speed, constant torque). Refer to the application chart found on page 17 for use of general purpose three phase motors on variable frequency drives.

Continued on next page.

Variable Speed Operation

CONSTANT TORQUE LOADS (Cont'd.)

Applications requiring greater than 20:1 C.T. are ideal for microMAX™, Black Max® or Blue Max® motors. These motors provide full rated torque within their listed speed range, without exceeding a Class F temperature rating while under inverter power (many operate at Class B). Ratings in this catalog have been developed, based on extensive testing on IGBT inverters, set at a minimum 3 KHz (or equivalent) carrier frequency.

Vector Duty and Inverter Duty motors from Marathon Electric are designed for operation at 150% of rated load for one minute, up to the base speed of the motor (overload capability declines to 100% as the motor reaches maximum constant HP speed). These motors accommodate constant horsepower operation to 1-1/2 to 2 times base speed, subject to the motor's maximum safe mechanical speed limit. Refer to the Maximum Safe Mechanical Speed Chart, as well as the performance section for each motor's capability.

Motors rated for zero RPM continuous duty (1000:1 or 2000:1) must be powered by vector drives to produce rated torque without overheating. Optimum zero speed and low-speed full torque performance may require a closed loop vector drive (with encoder feedback).

CONSTANT HORSEPOWER LOADS – Applications include coil winders, band saws, grinders, and turret lathes. Operation requires the motor to deliver the same horsepower rating, regardless of shaft speed. Torque increases at low speed and decreases at higher speed. Most general purpose motors can deliver constant horsepower up to 1 1/2 times base speed (consult a factory representative to verify performance). However, many constant HP applications require operation to twice base speed, and some, such as coil winders, up to 4 times base speed. microMAX™, Black Max® and Blue Max® motors are designed for 1 1/2 to 2 times base speed, and the Wide CHP motors, found in Marathon's SB371 Catalog, deliver up to 4 times constant horsepower performance.

BEARING CURRENTS – As stated in NEMA MG1-31.4.4.3, to protect a motor from inverter-sourced shaft voltages, either both bearings must be insulated or the motor shaft must be effectively grounded. Marathon Electric offers several effective means to protect the bearings from inverter sourced EDM (electrical discharge machining). A Shaft Grounding device is standard in Blue Max® motors, in frame sizes 444T and larger. Insulating the motor bearings will not prevent damage to bearings of a connected load, and insulated couplings should be employed to protect the load. Adding a ground brush to a motor with insulated bearings will divert motor shaft currents and help protect the bearings of the connected load. At this time, UL policy prohibits the use of ground brushes or insulated bearings in Hazardous Locations (Div 1 & 2, Zones 1, 2, 21 & 22).

MOTOR GROUNDING - Frames and accessories of all motors must be grounded in accordance with the National Electric Code (NEC) Article 430. Refer to NEC Article 250 for general

information on grounding. Proper grounding of inverter-driven motors is essential to protect personnel and livestock from inverter-sourced common mode voltages, which may reach hazardous levels on the frame of ungrounded or poorly grounded motors.

LOW INPUT VOLTAGE – If, due to lower utility supply voltage, the input voltage from the VFD to the motor is lower than the motor's rated voltage, de-rating of the motor's base frequency, horsepower, full load RPM, and constant HP RPM is required. The revised values can be calculated by multiplying by the ratio of the voltage change. For example, to operate a 460 volt motor from an inverter fed by 50 or 60 HZ, 400 volt utility power, the multiplier is 400/460 or 0.87.

The VFD can be reprogrammed to match the new base point values, allowing the motor to provide rated torque at rated current from the new base speed down to its original minimum Constant torque speed. The motor's CHP range will begin at the new base frequency and will be shortened by the same ratio as described above.

OVERSPEED CAPABILITY – Maximum safe mechanical speed capability is a function of bearing size and type, lubrication, rotor balancing technique and specifications, air gap, enclosure, frame construction and connection to the driven load. In addition, consideration must be given to ambient noise levels, as operation above base speed will increase motor noise and vibration, and reduce bearing life. Under no circumstances should bearing hub temperature exceed 100°C. Belted loads should not exceed 60 Hz operating RPM by more than 25% (NEMA "TS" shafts are not suitable for belted loads). Due to external cooling fans, TEFC (and Explosion Proof Fan Cooled) motors are limited to 4000 RPM maximum speed.

Marathon Electric, through extensive testing in our state-of-the-art laboratory and in actual field experience, has developed a number of high speed motors whose maximum safe mechanical speed exceeds the values in the table below. The following table depicts maximum safe speed limits for continuous operation, direct-coupled, non-explosion proof motors, and does not imply constant horsepower capability. Please consult a factory representative for requirements beyond those listed, or for intermittent duty limits.

**Maximum Safe Mechanical Speed Limits
(ODP, TENV, DPFV OR TEBC ENCLOSURES)
60 Hz base frequency**

Frame Size	2-Pole	4, 6 or 8-Pole
56-184	7200	5400
213-256	5400	4200
284-286	5400	3600
324-326	4000	3600
364-365	4000	2800
404-449	3600	2800
5000 Fr	N/A	CALL
6800 Fr	N/A	CALL



Variable Speed Operation

OTHER APPLICATION CONSIDERATION

For proper selection, the following should be considered:

- Horsepower or torque requirements at various speeds.
- Desired speed range of the load and motor.
- Acceleration and deceleration rate requirements of the process being controlled.
- Starting requirements including the frequency of starting and a description of the load (reflected inertia at the motor, load torque during starting).
- Whether the application is a continuous process or duty cycle of starts, stops and speed changes.
- A general description of the type of application including the environment in which the VFD system components must operate (determines motor enclosure and/or explosion proof classification).
- Description of the available electrical power supply and wiring.
- Special performance requirements, if any.
- Whether the drive will be configured with a by-pass circuit. In case of its deployment, the motor will operate like its fixed speed counterpart and may require a NEMA B design which limits in-rush current, or selection of a larger motor starter or other protective circuitry.
- Load sharing
- Mounting and other mechanical considerations

Typical Temperature Rise Of Various Enclosures

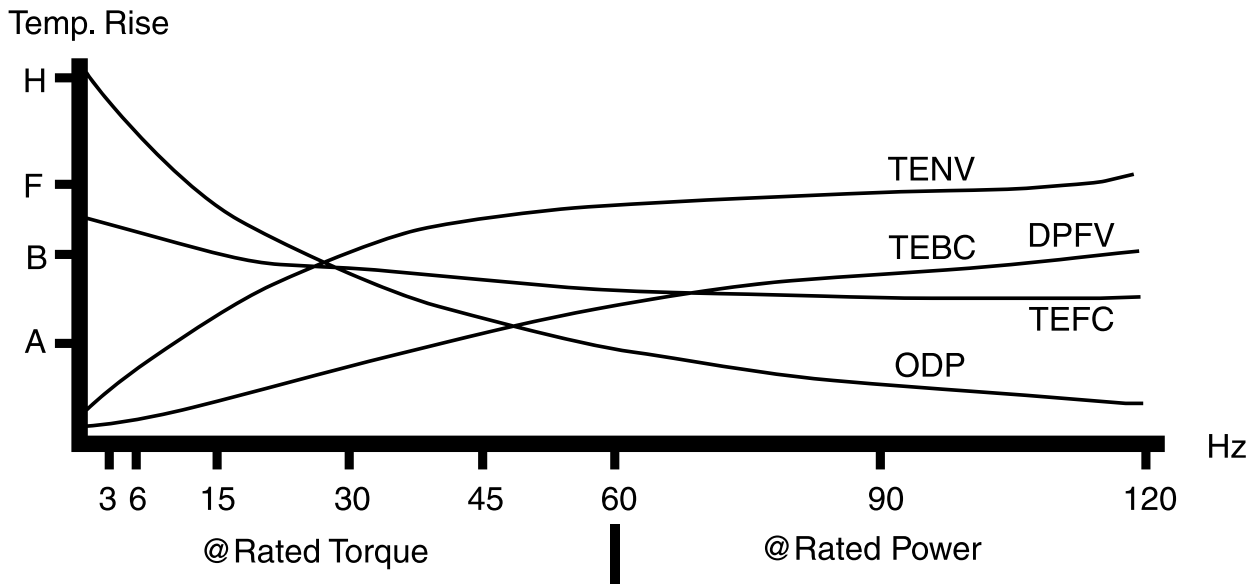

General Purpose, Single Phase (NEMA Service Factor), Dripproof



Features:

- Heavy gauge steel frame and base
- Ball bearings (except as noted)
- Economical split phase or capacitor start designs, as noted
- Service Factor, as noted
- UL Recognized and CSA Certified

Rigid Base

HP	RPM	VOLTS	FRAME	OVER LOAD	CAT. NO.	MODEL NO.	STOCK	LIST PRICE	MULT. SYMB.	F.L. AMPS	WEIGHT	"C" DIM.	FOOT NOTES
1/6	1800	115	48	AUTO	4349	5KH39QN9537X	✓	\$143	F1	3.9	12	8.94	3,7,20
1/4	1800	115	48	NONE	4354	5KH39QN9538	✓	\$146	F1	5.1	13	8.94	3,7,20
	1800	115	48	NONE	H239	5KH33FN6	✓	\$197	F1	5.6	13	8.87	d,3,7,20
	1800	115	48	AUTO	4362	5KH39QN9686X	✓	\$151	F1	5.1	13	8.94	3,7,20
	1800	115/208-230	48	MANUAL	G078	48C17D2034	✓	\$202	F1	5.0/2.3-2.5	17	9.84	2,20
	1800	115/208-230	48	NONE	C147	5KC35JN10	✓	\$187	F1	5.2/2.7-2.6	16	9.25	2,7,20
	1800	115/208-230	48	AUTO	C148	5KC35JN10X	✓	\$253	F1	5.2/2.7-2.6	16	9.25	2,7,20
	1800	115/230	48	AUTO	C145	5KC35JN8X	✓	\$227	F1	5.2/2.6	16	9.57	d,2,7,20
	1500	110/220	48	NONE	C431	5KC36LN18	✓	\$275	F1	5.6/2.8	17	9.66	2,7,20,50
1/3	3600	115/208-230	48	NONE	G091	48C34D2025		\$161	F1	4.4/2.2-2.2	17	10.09	2,20
	1800	115/208-230	48	NONE	C153	5KC36LN30	✓	\$268	F1	6.0/3.2-3.0	18	9.66	2,7,20,68
	1800	115/208-230	48	AUTO	C154	5KC36LN30X	✓	\$280	F1	6.0/3.2-3.0	18	9.66	2,7,20,68
	1800	115/208-230	56	NONE	C158	5KC36LN7	✓	\$227	F1	6.0/3.2-3.0	18	10.32	2,7,20,68
	1800	100-120/200-240	56	NONE	E253	5KCR46JN0085	✓	\$327	F1	4.0-3.8/2.0-1.9	23	10.77	ES,1,20,68
	1800	115/208-230	56	AUTO	C159	5KC36LN7X	✓	\$235	F1	6.0/3.2-3.0	18	10.32	2,20,68
	1800	115/208-230	56	MANUAL	G095	56C17D2010	✓	\$242	F1	6.4/3.0-3.2	18	10.22	2,20
	1200	115/230	56	NONE	C1252	5KC49PN6070	✓	\$338	F1	8.6/4.3	89	11.48	2,20,68
1/2	3600	115/230	48	NONE	G1098	5KC36JN266	✓	\$180	F1	7.6/3.8	15	9.66	2,7,19
	3600	115	56	MANUAL	9031	5KC49MN2043Y	✓	\$215	F1	11.5	20	11.14	2,17
	3600	115/230	56	MANUAL	C1474	5KC37LN502Y	✓	\$265	F1	7.4/3.7	17	10.72	2,17
	3000	110/220	48	NONE	C459	5KC37MN96	✓	\$300	F1	7.8/3.9	20	10.06	2,7,19
	1800	115/230	48	NONE	C164	5KC37NN15	✓	\$332	F1	9.2/4.6	20	10.40	2,7,19
	1800	110-120/200-240	56	NONE	E262	5KCR46MN0092	✓	\$384	F1	5.8-5.6/2.9-2.8	27	10.77	ES,1,19,68
	1800	115/208-230	56	NONE	C167	5KC49GN0010	✓	\$253	F1	8.8/4.2-4.4	21	10.38	2,19
	1800	115/230	56	AUTO	C168	5KC49GN0010X	✓	\$277	F1	8.8/4.4	21	10.38	2,19
	1800	115/230	56	MANUAL	C169	5KC49GN0010Y	✓	\$284	F1	8.8/4.4	31	10.38	2,19
	1200	115/230	56	NONE	C1263	5KC48UN6073	✓	\$433	F1	9.4/4.7	34	12.76	2,19
3/4	3600	115/208-230	56	NONE	G915	56C34D2100	✓	\$233	F1	9.6/4.4-4.8	21	10.97	2,19
	3600	115	56	MANUAL	9032	5KC49MN2049Y	✓	\$249	F1	12.5	27	11.14	2,17
	3600	115/230	56	MANUAL	C1475	5KC37NN501Y	✓	\$321	F1	10.2/5.1	18	10.72	2,19
	1800	100-120/200-240	56	NONE	EG271	5KCR49PN0097	✓	\$482	F1	9.0-8.8/4.5-4.4	31	11.37	ES,1,19,68
	1800	115/208-230	56	NONE	C175	5KC46LN0153	✓	\$317	F1	13.2/6.2-6.6	25	10.78	2,19
	1800	115/230	56	AUTO	C176	5KC46LN0153X	✓	\$366	F1	13.2/6.6	24	10.78	2,19
	1800	115/208-230	56	MANUAL	G919	56B17D2010	✓	\$346	F1	11.0/5.5-5.5	26	11.47	1,19
	1800	115/208-230	56	MANUAL	C1298	5KC46NN0758Y	✓	\$346	F1	11.2/5.8-5.6	26	10.34	2,19
	1800	115/230	56	MANUAL	C177	5KC46LN0153U	✓	\$388	F1	13.2/6.6	24	10.78	2,19
	1200	115/230	56	NONE	C178	5KCR49WN6075	✓	\$554	F1	12.6/6.3	44	13.96	ES,1,18
1	3600	115/208-230	56	NONE	C179	5KC38RN60	✓	\$264	F1	12.4/6.4-6.2	24	11.04	2,19
	3600	115/208-230	56	AUTO	C180	5KC38RN60X	✓	\$338	F1	12.4/6.4-6.2	24	11.04	2,19
	3600	115/230	56	MANUAL	9033	5KC49NN2050Y	✓	\$285	F1	16.0/8.0	23	11.14	d,2,17
	3600	115/208-230	56	MANUAL	D010	56B34D2029	✓	\$285	F1	10.6/5.5-5.3	23	11.72	1,18
	3600	115/230	56	MANUAL	C702	5KC38RN4153Y	✓	\$407	F1	12.8/6.5	20	11.04	2,18
	1800	100-120/200-240	56H	NONE	E280	5KCR48UN0104	✓	\$343	F1	11.8-11.4/5.9-5.7	39	12.66	ES,1,18
	1800	115/208-230	56	NONE	C181	5KC49PN0161	✓	\$343	F1	13.6/6.7-6.8	31	11.38	2,18
	1800	115/208-230	56	AUTO	C182	5KC49PN0161X	✓	\$365	F1	13.6/6.6-6.8	31	11.38	2,18
	1800	115/230	56	MANUAL	C1480	5KC49PN0161U	✓	\$377	F1	13.6/6.8	31	11.38	2,18
	1800	115/208-230	143T	NONE	C188	5KC49PN0162	✓	\$343	S1	13.6/6.7-6.8	31	11.77	2,11,18
	1200	115/230	56H	NONE	C183	5KCR49QN6076	✓	\$499	F1	12.6/6.3	54	14.93	ES,1,18
	1200	115/230	182T	NONE	I141	182TCDR17079		\$574	S1	15.0/7.5	87	15.72	13,18

SINGLE PHASE

Continued on next page.



General Purpose, Single Phase (NEMA Service Factor), Dripproof



Rigid Base

HP	RPM	VOLTS	FRAME	OVER LOAD	CAT. NO.	MODEL NO.	STOCK	LIST PRICE	MULT. SYMB.	F.L. AMPS	WEIGHT	"C" DIM.	FOOT NOTES
1 1/2	3600	115/208-230	56	NONE	G937	56B34D2026	✓	\$352	F1	14.8/8.0-7.4	25	11.72	1,18
	3600	115/230	56	MANUAL	C1477	5KC49PN2144Y	✓	\$463	F1	16.8/8.4	29	11.82	2,18
	3600	115/230	56	MANUAL	C704	5KC49PN2521Y	✓	\$369	F1	21.3 / 10.6	31	11.91	2,18
	3600	115/208-230	143T	NONE	I101	143TCDR5303		\$366	S1	18.8/9.7-9.4	30	10.99	2,14,18
	1800	115/230	56	NONE	C1299	5KCR48WN0756Y		\$443	F1	13.4/6.7	35	12.45	ES,1,110
	1800	115/208-230	56H	MANUAL	G951	56C17D5308	✓	\$443	F1	18.0/9.3-9.0	39	12.44	2,14,18
	1800	115/208-230	56H	NONE	C185	5KCR49SN0068	✓	\$408	F1	18.2/9.1-9.1	35	11.90	ES,1,18
	1800	115/208-230	56H	AUTO	C186	5KCR49SN0068X	✓	\$424	F1	18.2/9.1	35	11.90	ES,1,18
	1800	115/208-230	145T	NONE	C191	5KCR49SN0065	✓	\$415	S1	18.2/9.1-9.1	35	12.30	ES,1,18
	1200	115/230	184T	NONE	I142	184TCDR7076		\$714	S1	23.0/11.5	72	15.72	2,13,18
2	3600	115/230	56	NONE	C187	5KC48TN2169	✓	\$424	F1	21.2 / 10.6	38	12.66	2,18
	3600	115/230	56	MANUAL	9035	5KCR48TN2650Y	✓	\$462	F1	15.0/7.5	38	12.76	ES,1,17
	3600	115/230	56	MANUAL	C703	5KC49RN2520Y	✓	\$579	F1	23.8/11.8	33	11.91	2,18
	3600	115/208-230	145T	NONE	I102	145TBDR5302	✓	\$436	S1	19.2/10.5-9.6	35	11.49	1,18
	1800	115/208-230	56HZ	NONE	C193	5KCR49WN0270	✓	\$433	F1	22.0/10.9-11.0	44	14.33	ES,1,11,18
	1800	115/208-230	56HZ	AUTO	CG381	5KCR49WN0270T	✓	\$556	F1	22.0/10.9-11.0	44	14.33	ES,1,11,18
	1800	115/208-230	145T	MANUAL	I127	145TBDR5337	✓	\$531	S1	18.8/10.2-9.4	48	13.49	1,11,18
	1800	115/208-230	182T	NONE	I112A	182TCDW7026	✓	\$484	S1	23.0/12.3-11.5	62	13.19	2,13,18
	1200	115/208-230	213T	NONE	I143	213TCDW7076	✓	\$887	S1	30.0/15.5-15.0	138	16.55	2,18
3	3600	230	56	MANUAL	9036	5KCR48UN2653Y	✓	\$602	F1	14.5	40	12.64	ES,1,17
	3600	115/230	145T	NONE	C194	5KCR48TN8062	✓	\$610	S1	29.4/14.7	38	13.13	ES,1,18
	3600	208/230	145T	NONE	I145	145TBDR5303		\$472	S1	13.5-12.5	40	11.99	1,7,17
	3600	115/208-230	182T	NONE	I103A	182TCDW7001	✓	\$544	S1	32.0/17.1-16.1	62	13.69	2,13,18
	1800	115/208-230	184T	NONE	I113A	184TCDW7026	✓	\$566	S1	33.5/17.4-16.8	78	14.21	2,13,18
	1200	230	215T	NONE	I144	215TBDW7079		\$1,222	S1	16.0	134	18.05	1,18
5	3600	230	56H	MANUAL	D017	56B34D5302	✓	\$640	F1	20.0	55	13.94	1,5,18
	3600	208-230	184T	NONE	I104A	184TBDW17008	✓	\$731	S1	24.0-22.0	79	14.69	2,13,18
	1800	208-230	184T	NONE	I114A	184TBDW7026	✓	\$686	S1	23.0-21.0	82	14.71	1,13,18
	1800	208-230	213T	NONE	I117	213TCDW7026		\$934	S1	30.5-28.0	108	16.55	2,18
7 1/2	3600	208-230	184T	NONE	I108A	184TBDW7001	✓	\$770	S1	34.0-31.0	103	16.69	1,13,18
	3600	208-230	213T	NONE	I105	213TCDW7001	✓	\$1,041	S1	40.0-37.0	105	16.55	2,18,F
	1800	208-230	215T	NONE	I115	215TBDW7026	✓	\$1,027	S1	37.2-34.5	115	18.05	1,18
10	3600	208-230	215T	NONE	I106	215TCDW17002	✓	\$1,335	S1	51.0-46.0	193	18.05	2,18,F
	1800	208-230	215T	NONE	I116	215TBDW7028	✓	\$1,322	S1	49.0-44.0	140	19.30	1,7,18

SINGLE PHASE

Extended Thru-Bolts, Split Phase - Steel Endshields

HP	RPM	VOLTS	FRAME	OVER LOAD	CAT. NO.	MODEL NO.	STOCK	LIST PRICE	MULT. SYMB.	F.L. AMPS	WEIGHT	"C" DIM.	FOOT NOTES
1/4	1800	115	48Z	NONE	H901	5KH32DNA612	✓	\$126	F1	5.1	11	9.83	9,18,28
	1800	115	48Z	AUTO	H902	5KH32DNA612X	✓	\$131	F1	5.1	11	9.83	9,18,28
1/3	1800	115	48Z	NONE	H903	5KH32FNA611	✓	\$130	F1	5.5	14	9.83	9,18,28
	1800	115	48Z	AUTO	H904	5KH32FNA611X	✓	\$135	F1	5.5	12	9.83	9,18,28
1/2	1800	115	56Z	NONE	H905	5KH36JNA769	✓	\$153	F1	8.1	16	10.89	10,18,28
	1800	115	56Z	AUTO	H906	5KH36JNA769X	✓	\$158	F1	8.1	16	10.89	10,18,28
3/4	1800	115	56Z	NONE	H907	5KH37NNA768	✓	\$187	F1	11.2	18	11.29	10,17
	1800	115	56Z	AUTO	H908	5KH37NNA768X	✓	\$192	F1	11.2	33	11.29	10,17

Special Purpose, Single Phase (1.0 Service Factor), Dripproof

Features:

- Heavy gauge steel frame and base
- Ball bearings (except as noted)
- Economical split phase or capacitor start designs, as noted
- 1.0 Service Factor
- UL Recognized and CSA Certified



Rigid Base

HP	RPM	VOLTS	FRAME	OVER LOAD	CAT. NO.	MODEL NO.	STOCK	LIST PRICE	MULT. SYMB.	F.L. AMPS	WEIGHT	"C" DIM.	FOOT NOTES
1/4	1800	115	48	NONE	4351	5KH39QN9542	✓	\$112	F1	5.7	13	8.94	d,3,7
	1800	115	48	NONE	S003	48S17D2089	✓	\$112	F1	5.7	12	9.09	3,7
	1500	110/220	48	AUTO	H689	5KH35JN603X	✓	\$230	F1	5.2/2.6	15	9.23	3,7,50
1/3	1800	115	48	AUTO	4380	5KH39QN9681X	✓	\$161	F1	6.2	14	8.94	d,3,7
	1800	115	48	AUTO	S026	48S17D2113	✓	\$130	F1	6.6	14	9.34	3,7
	1800	115	48	NONE	4368	5KH39QN9397	✓	\$125	F1	6.2	14	8.94	3,7
	1800	115	48	NONE	S006	48S17D2090	✓	\$125	F1	6.6	14	9.34	3
	1800	115	48	NONE	H229	5KH35HN9	✓	\$204	F1	6.8	15	9.25	3,7
	1800	115/230	48	NONE	S010	48C17D2023	✓	\$169	F1	7.0/3.5	15	9.34	2
	1800	115/230	48	MANUAL	S030	48C17D2027	✓	\$202	F1	7.0/3.5	16	9.34	2
	1800	115/230	48	AUTO	S011	48C17D2024	✓	\$177	F1	7.0/3.5	16	9.34	
	1800	230	48	NONE	4373	5KH39QN9543	✓	\$176	F1	3.3	14	8.94	3,7
	1800	115	48Z	NONE	4376	5KH39QN9547		\$168	F1	6.2	15	10.36	3,7
	1800	115	56Z	NONE	4372	5KH39QN9546	✓	\$172	F1	6.2	15	8.94	3,7
	1800	115	56Z	NONE	H676	5KH35GNA229	✓	\$204	F1	6.2	14	9.57	3,7
	1800	115/230	56	MANUAL	CG105	5KC35JN27Y	✓	\$242	F1	6.6/3.3	16	9.89	d,2
	1500	110/220	48	AUTO	H691	5KH36LN488X	✓	\$246	F1	7.0/3.5	17	9.66	3,7
	1/2	1800	115	48	NONE	H696	5KH36LNA504	✓	\$243	F1	8.3	15	9.68
1800		115	56	AUTO	9029	5KC49NN0221X	✓	\$219	F1	8.7	20	11.14	2
1800		115	56	AUTO	S027	56S17D2066	✓	\$166	F1	9.2	19	10.22	3
1800		115	56	NONE	H230	5KH39QN9091		\$159	F1	8.3	16	10.32	3,7
1800		115	56	NONE	S022	56S17D2046	✓	\$159	F1	9.2	17	10.22	3
1800		115/230	56	NONE	S012	56C17D2098	✓	\$208	F1	9.2/4.6	18	10.22	2
1800		115/230	56	MANUAL	S033	56C17D2064	✓	\$242	F1	9.2/4.6	18	10.22	2
1800		115/230	56	AUTO	S013	56C17D2051	✓	\$217	F1	9.2/4.6	18	10.22	2
1800		115/230	56Z	NONE	CG393	5KC36MN20	✓	\$292	F1	8.2/4.1	17	12.30	2
3/4		3600	115/230	48	NONE	CG111	5KC37LN91	✓	\$416	F1	11.2/5.6	19	10.06
	1800	115/230	56	MANUAL	S036	56C17D2067	✓	\$284	F1	10.4/5.2	24	11.97	2
	1800	115/230	56	AUTO	S015	56C17D2055	✓	\$259	F1	10.4/5.2	24	11.97	2
	1800	115/230	56	NONE	S014	56C17D2054	✓	\$249	F1	10.4/5.2	24	11.97	2
1	3600	115/230	56Z	NONE	C449	5KC37NN160	✓	\$327	F1	13.4/6.7	20	12.60	2
	1800	115/230	56	MANUAL	S039	56C17D5320	✓	\$369	F1	13.6/6.8	27	10.94	2
	1800	115/230	56	AUTO	S038	56C17D5343	✓	\$343	F1	13.6/6.8	27	10.94	2
	1800	115/230	56	NONE	S037	56C17D5319	✓	\$335	F1	13.6/6.8	28	10.94	2
1 1/2	3600	115/230	56	MANUAL	9034	5KC49NN2044Y	✓	\$281	F1	19.0/9.5	29	11.14	2
2	3600	115/230	56	MANUAL	9035	5KCR48TN2650Y	✓	\$462	F1	17/8.5	38	12.76	ES,1
3	3600	208-230	145T	NONE	1145	145TBDR5303		\$472	S1	13.5/12.5	40	12.49	1
5	3600	230	56H	MANUAL	9038	5KCR49ZN2151U	✓	\$640	F1	21.0	49	15.04	ES,1

SINGLE PHASE

General Purpose, Single Phase (NEMA Service Factor), Dripproof

Features:

- Heavy gauge steel frame and base
- Ball bearings (except as noted)
- Thermal protection, as noted
- Capacitor start design for high starting torque
- Capacitor start/capacitor run design for higher efficiency, as noted
- 48Y and 48YZ have 48/56 Fr mounting holes
- Service Factor, as noted
- UL Recognized and CSA Certified



Resilient Base

HP	RPM	VOLTS	FRAME	OVER LOAD	CAT. NO.	MODEL NO.	STOCK	LIST PRICE	MULT. SYMB.	F.L. AMPS	WEIGHT	"C" DIM.	FOOT NOTES	
1/4	1800	115	48	AUTO	CG201	5KC35JN12X	✓	\$223	F1	5.2	16	9.57	d,4,7,20	
	1800	115	48	NONE	C200	5KC35JN12	✓	\$218	F1	5.2	16	9.57	d,7,20	
	1800	115/230	48	NONE	G1114	5KC35JN7	✓	\$173	F1	5.2/2.6	16	9.57	7,20	
	1800	115/230	48	AUTO	G1115	5KC35JN7X	✓	\$183	F1	5.2/2.6	16	9.57	7,20	
	1500	110/220	48	AUTO	C460	5KC36LN19X	✓	\$281	F1	5.6/2.8	18	10.00	7,20,50	
1/3	3600	115/230	48	AUTO	C208	5KC35FN51X	✓	\$237	F1	6.8/3.4	15	9.57	7,20	
	1800	100-120/200-240	56	AUTO	E254	5KCR46JN0086X	✓	\$337	F1	4.0-3.8/2.0-1.9	25	10.77	ES,1,20,68	
	1800	115/208-230	48	NONE	C209	5KC36LN26	✓	\$269	F1	6.0/3.2-3.0	18	10.00	7,20,68	
	1800	115/208-230	48	AUTO	C210	5KC36LN26X	✓	\$284	F1	6.0/3.2-3.0	18	10.00	7,20,68	
	1800	115/230	56	AUTO	G135	56C17D2088	✓	\$221	F1	6.4/3.2	18	10.22	20	
	1800	115/208-230	56	NONE	C215	5KC36LN1	✓	\$292	F1	6.0/3.2-3.0	18	10.32	20,68	
	1800	115/208-230	56	AUTO	C216	5KC36LN1X	✓	\$241	F1	6.0/3.2-3.0	18	10.32	20,68	
	1500	110/220	56	AUTO	C457	5KC37NN14T	✓	\$341	F1	7.4/3.7	20	10.72	20,50	
	1200	115/230	56	NONE	C1258	5KC49PN6051	✓	\$396	F1	8.6/4.3	28	11.38	20	
	1200	115/230	56	AUTO	C548	5KC49PN6051X	✓	\$407	F1	8.6/4.3	28	11.38	20	
1/2	3600	115/208-230	48	AUTO	C1152	5KC39QN3220X	✓	\$175	F1	8.2/3.9-4.1	19	11.00	7,19	
	1800	100-120/200-240	56	AUTO	E263	5KCR46MN0054X	✓	\$405	F1	5.8-5.6/2.9-2.8	27	10.77	ES,1,19,68	
	1800	115/208-230	56	NONE	B1316	5KC49GN0001	✓	\$259	F1	8.8/4.2-4.4	21	10.38	19	
	1800	115/208-230	56	AUTO	C1153	5KC49GN0022X	✓	\$293	F1	8.6/4.1-4.3	21	10.38	19	
	1800	115/208-230	56	AUTO	B317	56C17D2072	✓	\$299	F1	8.0/4.1-4.0	20	10.47	CF,19,31	
	1800	115/230	56	AUTO	CG223	5KC49GN0001X	✓	\$314	F1	8.8/4.4	21	10.38	19	
	1800	115/230	56	AUTO	D111	56C17D2079	✓	\$263	F1	7.2/3.6	20	10.72	19	
	1800	115/230	56	AUTO	G151	56C17D2025	✓	\$263	F1	8.6/4.3	24	11.72	19	
	1200	115/230	56	NONE	C1264	5KC48UN6052	✓	\$564	F1	9.4/4.7	40	12.76	19	
	1200	115/230	56	AUTO	C552	5KC48UN6052X	✓	\$576	F1	9.4/4.7	36	12.76	19	
	3/4	3600	115/208-230	48	AUTO	C1154	5KC38NN413X	✓	\$322	F1	10.0/4.9-5.0	17	11.00	7,19
		3600	115/208-230	56	AUTO	C1155	5KC38NN410X	✓	\$228	F1	10.0/4.9-5.0	17	11.32	19
		1800	100-120/200-240	56	AUTO	EG272	5KCR49PN0098X	✓	\$501	F1	9.0-8.8/4.5-4.4	31	11.37	ES,1,17,68
1800		115/208-230	56	NONE	G156	56B17D2012	✓	\$324	F1	11.0/5.5-5.5	26	11.47	1,19	
1800		115/208-230	56	AUTO	C1156	5KC46LN0149X	✓	\$353	F1	13.3/6.5-6.6	27	10.78	19	
1800		115/208-230	56	AUTO	B319	56C17D2074	✓	\$363	F1	10.0/5.2-5.0	23	11.72	CF,19,31	
1800		115/208-230	56	NONE	CG230	5KC46LN0158	✓	\$326	F1	13.2/6.2-6.6	25	10.78	19	
1800		115/208-230	56	NONE	B318	56C17D2073	✓	\$337	F1	10.0/5.2-5.0	24	11.72	CF,19,31	
1800		115/208-230	56	AUTO	C138	5KC46JN0002X	✓	\$352	F1	11.4/5.6-5.7	23	10.78	19	
1800		115/230	56	AUTO	D1113	5KC46LN0158X	✓	\$325	F1	13.2/6.6	25	10.78	19	
1500		110/220	56	AUTO	C1187	5KC49NN0224X	✓	\$463	F1	12.2/6.1	28	11.38	19,50	
1200		115/230	56	NONE	CG232	5KCR49WN6007	✓	\$652	F1	12.6/6.3	42	13.96	1,18	
1		3600	115/208-230	56	AUTO	C1157	5KC39RN383X	✓	\$284	F1	13.4/6.7-6.6	25	11.90	19
		3600	115/208-230	56	AUTO	D118	56C34D2106	✓	\$266	F1	12.0/6.2-6.0	25	12.22	18
	1800	100-120/200-240	56H	AUTO	E281	5KCR48UN0105X	✓	\$526	F1	11.8-11.4/5.9-5.7	40	12.65	ES,1,18,68	
	1800	115/208-230	56	AUTO	C1158	5KC49PN0164X	✓	\$369	F1	14.7/7.2-7.4	29	11.38	18	
	1800	115/208-230	56	NONE	C235	5KC49PN0155	✓	\$344	F1	13.6/6.7-6.8	31	11.38	5,18	
	1800	115/230	56	AUTO	CG236	5KC49PN0155X	✓	\$418	F1	13.6/6.8	30	11.38	18	

Continued on next page.

General Purpose, Single Phase (NEMA Service Factor), Dripproof

Resilient Base

HP	RPM	VOLTS	FRAME	OVER LOAD	CAT. NO.	MODEL NO.	STOCK	LIST PRICE	MULT. SYMB.	F.L. AMPS	WEIGHT	"C" DIM.	FOOT NOTES
1 1/2	3600	115/208-230	56H	AUTO	C1159	5KC49RN2152T	✓	\$370	F1	19.6/9.8-9.8	33	12.01	d,18
	3600	115/208-230	56	AUTO	D115	56B34D2027	✓	\$370	F1	13.4/7.4-6.7	28	11.72	1,18
	1800	115/208-230	56H	NONE	B336	56C17D5347	✓	\$413	F1	18.0/9.3-9.	39	12.85	5,18,32
	1800	115/208-230	56H	AUTO	CG239	5KCR49SN0012X	✓	\$491	F1	18.2/9.1	35	11.91	ES,1,5,18
	1800	115/208-230	56H	AUTO	C1160	5KCR49SN0150X	✓	\$429	F1	16.4/8.4-8.2	35	11.90	ES,1,18
	1800	115/208-230	145T	NONE	I146	145TCDR5331	✓	\$419	S1	18.0/9.3-9.	42	13.22	18,32
2	3600	115/208-230	56H	AUTO	K152	56B34D5320	✓	\$450	F1	19.2/10.5-9.6	33	11.85	d,1,5,18
	3600	115/208-230	56H	AUTO	C1161	5KCR49RN2148T	✓	\$451	F1	19.6/10.4-9.8	33	11.91	ES,1,5,110
	1800	115/208-230	56H	AUTO	B325	56B17D5331	✓	\$547	F1	21.0/11.3-10.5	50	13.85	1,5,18
	1800	115/208-230	145T	NONE	I147	145TBDR5345	✓	\$440	S1	21/11.3-10.5	49	14.22	1,18

Two Speed, Variable Torque, Resilient Base

HP	RPM	VOLTS	FRAME	OVER LOAD	CAT. NO.	MODEL NO.	STOCK	LIST PRICE	MULT. SYMB.	F.L. AMPS	WEIGHT	"C" DIM.	FOOT NOTES
1/2-1/6	1800/1200	115	56	AUTO	C419	5KC49PN3027X	✓	\$499	F1	8.2/3.9	28	11.38	19
3/4-1/4	1800/1200	115	56	AUTO	C474	5KCR49PN3011X	✓	\$545	F1	9.0/6.4	31	11.48	ES,1,19
	1800/1200	115	56	NONE	C420	5KCR49PN3011	✓	\$463	F1	9.0/6.4	31	11.48	ES,1,19
	1800/1200	208-230	56	AUTO	C486	5KCR49PN3012X	✓	\$472	F1	4.3-4.4/3.1-3.2	38	11.48	ES,1,19
1 1/3	1800/1200	115	56	AUTO	C1478	5KCR49SN3009X	✓	\$601	F1	10.8/7.4	30	12.01	ES,1,18
	1800/1200	115	56	NONE	C475	5KCR49SN3009	✓	\$578	F1	10.8/7.4	35	12.01	ES,1,18
	1800/1200	208-230	56	NONE	C476	5KCR49SN3010	✓	\$601	F1	5.3-5.4/3.6-3.7	35	12.01	ES,1,18
	1800/1200	208-230/190-220	56H	AUTO	C1479	5KCR48TN3084X	✓	\$613	F1	5.3-5.4/3.6-3.7	36	12.54	ES,1,17

Special Purpose, Single Phase (1.0 Service Factor), Dripproof

Features:

- Heavy gauge steel frame and base
- Ball bearings (except as noted)
- 1.0 Service Factor
- Economical split phase or capacitor start designs, as noted
- 48Y and 48YZ have 48/56 Fr mounting holes
- UL Recognized and CSA Certified



Resilient Base

HP	RPM	VOLTS	FRAME	OVER LOAD	CAT. NO.	MODEL NO.	STOCK	LIST PRICE	MULT. SYMB.	F.L. AMPS	WEIGHT	"C" DIM.	FOOT NOTES
1/4	1800	115	48	AUTO	S103	48S17D2091	✓	\$125	F1	5.7	13	9.06	3,7,31
	1800	115	48	NONE	S102	48S17D2042	✓	\$119	F1	5.7	13	9.06	3,7
	1800	115/230	48	AUTO	S119	48C17D2046	✓	\$173	F1	6.2/3.1	13	9.06	2,7
	1800	115/230	48	NONE	S118	48C17D2045	✓	\$164	F1	6.2/3.1	14	9.06	2,7
	1800	115	48	NONE	H675	5KH33FNA230	✓	\$197	F1	5.0	14	9.19	3,7
	1800	115	48Z	AUTO	S126	48S17D2104	✓	\$125	F1	5.3	14	9.72	3,53
	1800	115	56Z	AUTO	4364	5KH39QN5541X	✓	\$169	F1	5.7	13	9.19	3,4,7
	1800	115	56Z	NONE	4359	5KH39QN5523	✓	\$165	F1	5.7	13	9.19	3,4,7
	1500	220	48	NONE	H645	5KH39QNB810	✓	\$223	F1	3.4	14	9.57	3,7,50
	1500	110/220	56Z	AUTO	HG690	5KH35JN602X	✓	\$237	F1	5.2/2.6	15	9.51	3,7,50

Continued on next page.

Special Purpose, Single Phase (1.0 Service Factor), Dripproof

Resilient Base

HP	RPM	VOLTS	FRAME	OVER LOAD	CAT. NO.	MODEL NO.	STOCK	LIST PRICE	MULT. SYMB.	F.L. AMPS	WEIGHT	"C" DIM.	FOOT NOTES
1/3	1800	115	48	NONE	4369	5KH39QN5508	✓	\$139	F1	6.2	14	8.94	3,7
	1800	115	48	NONE	S106	48S17D2093	✓	\$141	F1	6.5	14	9.31	3,7,31,CF
	1800	115/230	48	AUTO	C129	5KC35JN23X	✓	\$183	F1	6.4/3.2	16	9.57	2,7
	1800	115/230	48	AUTO	S111	48C17D2029	✓	\$183	F1	7.0/3.5	16	9.31	2,7
	1800	115/230	48	NONE	S110	48C17D2028	✓	\$173	F1	7.0/3.5	16	9.31	2,7
	1800	115	48	AUTO	4310	5KH39QN5508X	✓	\$137	F1	6.2	14	8.94	3,7
	1800	115	48Y	AUTO	S127	48S17D2105	✓	\$137	F1	6.6	14	9.72	3,5,3
	1800	115	48	NONE	H674	5KH35JNA231	✓	\$212	F1	6.6	15	9.57	3,7
	1800	115	56Z	NONE	4377	5KH39QN5524	✓	\$180	F1	6.2	15	9.19	3,7
	1800	115	56Z	AUTO	4381	5KH39QN5528X	✓	\$184	F1	6.2	15	9.19	3,7
	1800	115	56Z	AUTO	4776	5KH39QN5539T	✓	\$184	F1	6.2	16	9.19	d,3,7,5,7
	1800	230	48	NONE	4371	5KH39QN5529	✓	\$180	F1	3.3	14	8.94	3,7
	1800	230	48	AUTO	4311	5KH39QN5529X	✓	\$184	F1	3.3	14	8.93	3,7
	1500	110/220	56Z	AUTO	HG692	5KH36LN489X	✓	\$254	F1	7.0/3.5	17	9.94	3,5,0
	1500	220	56Z	NONE	H673	5KH33KN5594	✓	\$242	F1	3.5	17	9.19	3,7,5,0
1/2	1800	115	48Z	AUTO	HG710	5KH33JNA511T	✓	\$166	F1	7.9	15	9.93	3,9
	1800	115	48Z	AUTO	S128	48S17D2106	✓	\$166	F1	9.2	17	10.22	3,5,3
	1800	115	56	NONE	S120	56S17D2023	✓	\$164	F1	9.2	18	10.22	3,3,1
	1800	115	56Z	AUTO	4778	5KH39QN9639T	✓	\$254	F1	8.3	20	9.57	3,7
	1800	115/230	56Z	AUTO	S113	56C17D2099	✓	\$221	F1	9.1/4.5	19	10.22	2
	1800	115/230	56	NONE	S112	56C17D2097	✓	\$213	F1	9.1/4.5	19	10.22	2
	1800	115/230	48	AUTO	C133	5KC36MN27X	✓	\$308	F1	8.2/4.1	19	10.00	2,7
	1800	230	56	AUTO	4602	5KH39QN9518X	✓	\$275	F1	4.2	19	10.32	3
	1800	230	56	NONE	4387	5KH39QN9684	✓	\$267	F1	4.2	19	10.32	3
	1500	110/220	56	AUTO	H693	5KH46JN0329X	✓	\$283	F1	9.2/4.6	23	10.55	3
3/4	1800	115/230	56	NONE	S114	56C17D2060	✓	\$253	F1	10.4/5.2	25	11.97	2
	1800	115	56	NONE	4422	5KH39QN9687	✓	\$314	F1	11.2	21	10.72	3
	1800	115/230	56	AUTO	C1483	5KC46LN0254X	✓	\$263	F1	13.2/6.6	25	10.78	2
	1800	115/230	56	AUTO	S115	56C17D2061	✓	\$263	F1	10.4/5.2	25	11.97	2
1	1800	115/230	56	AUTO	S117	56C17D5340	✓	\$348	F1	13.6/6.8	28	11.35	2
	1800	115/230	56	NONE	S116	56C17D5339	✓	\$339	F1	13.6/6.8	29	11.35	2

SINGLE PHASE

General Purpose, Single Phase (NEMA Service Factor), Dripproof

Features:

- Heavy gauge steel frame and base
- Ball bearings mechanically locked on shaft end (excludes 5K models)
- Capacitor start design for high starting torque
- Capacitor start/capacitor run design for higher efficiency, as noted
- Service Factor, as noted
- UL Recognized and CSA Certified



C-Face Footless

HP	RPM	VOLTS	FRAME	OVER LOAD	CAT. NO.	MODEL NO.	STOCK	LIST PRICE	MULT. SYMB.	F.L. AMPS	WEIGHT	"C" DIM.	FOOT NOTES
1/4	1800	115/208-230	56C	NONE	G212	56C17D2084	✓	\$202	F1	5.0/2.3-2.5	17	10.69	20
	1800	115/208-230	56C	AUTO	C354	5KC35JN70X	✓	\$265	F1	5.2/2.7-2.6	15	9.61	20
1/3	3600	115/208-230	56C	NONE	G216	56C34D2117	✓	\$173	F1	4.4/2.2-2.2	17	10.19	20
	1800	100-120/200-240	56C	NONE	E251	5KCR46JN0084	✓	\$390	F1	4.0-3.8/2.0-1.9	23	10.77	ES,1,20,68
	1800	115/208-230	56C	AUTO	C356	5KC36LN83X	✓	\$307	F1	6.0/3.2-3.0	16	10.35	20,68
	1800	115/208-230	56C	NONE	C355	5KC36LN83	✓	\$237	F1	6.0/3.2-3.0	16	10.35	d,20,68
	1800	115/208-230	56C	NONE	G230	56C17D2085	✓	\$237	F1	6.4/3.0-3.2	17	10.69	20
1/2	3600	115/208-230	56C	NONE	G232	56C34D2108	✓	\$191	F1	8.4/3.8-4.2	17	10.69	19
	1800	100-120/200-240	56C	NONE	E260	5KCR46MN0091	✓	\$445	F1	5.8-5.6/2.9-2.8	25	10.77	ES,1,19,68
	1800	115/208-230	56C	NONE	C358	5KC49GN0009	✓	\$279	F1	8.8/4.2-4.4	21	10.38	19
	1800	115/208-230	56C	NONE	G234	56C17D2044	✓	\$279	F1	8.6/4.1-4.3	21	11.19	19
	1800	115/230	56C	AUTO	C359	5KC49GN0009X	✓	\$348	F1	8.8/4.4	21	10.38	19
	1200	115/208-230	56C	NONE	G278	56C11D5304	✓	\$446	F1	10.6/5.1-5.3	32	11.94	19
3/4	3600	115/208-230	56C	NONE	G238	56C34D2101	✓	\$245	F1	9.6/4.4-4.8	20	10.94	19
	1800	100-120/200-240	56C	NONE	E269	5KCR49PN0096	✓	\$482	F1	9.0-8.8/4.5-4.4	31	11.38	ES,1,19,68
	1800	115/230	56C	AUTO	CG362	5KC46LN0159X	✓	\$419	F1	13.2/6.6	24	10.78	19
	1800	115/208-230	56C	NONE	G250	56B17D2011	✓	\$342	F1	11.0/5.5-5.5	25	11.72	1,19
1	3600	115/208-230	56C	NONE	G254	56B34D2031	✓	\$281	F1	10.6/5.5-5.3	23	11.68	1,19
	1800	100-120/200-240	56C	NONE	E278	5KCR48UN0103	✓	\$555	F1	11.8-11.4/5.9-5.7	37	12.65	ES,1,18,68
	1800	115/230	56C	AUTO	CG363	5KC49PN0163X	✓	\$468	F1	13.6/6.8	24	11.38	18
	1800	115/208-230	56C	NONE	G256	56C17D5310	✓	\$367	F1	13.4/6.8-6.7	29	11.44	18
1 1/2	3600	115/208-230	56C	NONE	G258	56B34D2023	✓	\$365	F1	14.2/7.7-7.1	26	11.68	1,18
	1800	115/208-230	56C	NONE	G270	56C17D5311	✓	\$427	F1	18.0/9.3-9.0	39	12.44	18
2	3600	115/208-230	56C	NONE	G272	56B34D5319	✓	\$447	F1	19.2/10.5-9.6	32	11.44	1,18
	1800	115/208-230	56C	NONE	G274	56B17D5303	✓	\$521	F1	21.0/11.3-10.5	47	13.44	1,18
3	3600	115/208-230	182TC	NONE	C173	182TCDR8007	✓	\$598	S1	32.0/17.5-16.0	76	13.96	18
	1800	115/230	184TC	NONE	C174	184TCDR9627	✓	\$584	S1	33.0/16.5	52	15.96	18

SINGLE PHASE

General Purpose, Single Phase (NEMA Service Factor), Dripproof

Features:

- Ball bearings, mechanically locked on shaft end (excludes 5K models)
- NEMA Service Factors
- Heavy gauge steel frame and base
- Capacitor start design for high starting torque
- Capacitor start/capacitor run design for higher efficiency, as noted
- UL Recognized and CSA Certified



C-Face Footed (Rigid Base)

HP	RPM	VOLTS	FRAME	OVER LOAD	CAT. NO.	MODEL NO.	STOCK	LIST PRICE	MULT. SYMB.	F.L. AMPS	WEIGHT	"C" DIM.	FOOT NOTES
1/4	1800	115/208-230	56C	AUTO	K234	56C17D2114		\$217	F1	5.0/2.3-2.5	18	10.30	
1/3	1800	115/208-230	56C	AUTO	K235	56C17D2115	✓	\$252	F1	6.4/3.0-3.2	18	10.30	
	1800	100-120/200/240	56C	MANUAL	E250	5KCR46JN0083Y	✓	\$303	F1	4.0-3.8/2.0-1.9	24	10.77	d,ES,1,68
	1800	100-120/200/240	56C	AUTO	E252	5KCR46JN0083X	✓	\$252	F1	4.0-3.8/2.0-1.9	23	10.77	ES,1,68
1/2	1800	100-120/200-240	56C	AUTO	E261	5KCR46MN0090X	✓	\$293	F1	5.8-5.6/2.9-2.8	27	10.77	ES,1,68
	1800	100-120/200-240	56C	MANUAL	E259	5KCR46MN0090Y	✓	\$351	F1	5.8-5.6/2.9-2.8	27	10.77	d,ES,1,68
3/4	1800	100-120/200-240	56C	AUTO	E270	5KCR49PN0095X	✓	\$356	F1	9.0-8.8/4.5-4.4	31	11.37	ES,1,68
	1800	100-120/200-240	56C	MANUAL	E268	5KCR49PN0095Y	✓	\$405	F1	9.0-8.8/4.5-4.4	30	11.37	ES,1,68
1	1800	100-120/200-240	56C	MANUAL	EG277	5KCR48UN0102Y	✓	\$576	F1	11.8-11.4/5.9-5.7	40	12.65	d,ES,1,68
2	3600	115/208-230	56C	MANUAL	C1269	5KC49SN2537Y	✓	\$600	F1	15.6/8.8-7.8	36	11.34	
3	3600	208-230	56C	MANUAL	C1270	5KC49ZN2539Y	✓	\$733	F1	13.0-12.0	41	12.84	

General Purpose, Single Phase

Totally Enclosed

Features:

- Ball bearings
- Heavy gauge steel constructions
- Economical split phase or capacitor start designs, as noted
- Service Factor, as noted
- UL Recognized and CSA Certified



Rigid Base

HP	RPM	VOLTS	FRAME	OVER LOAD	CAT. NO.	MODEL NO.	STOCK	LIST PRICE	MULT. SYMB.	F.L. AMPS	WEIGHT	"C" DIM.	FOOT NOTES
1/6	1800	115	48	NONE	H116	5KH32EN66	✓	\$227	F1	4.0	15	9.92	3,17
	900	115/230	56	NONE	C248	5KC49PN3036	✓	\$591	F1	5.6/2.8	28	12.43	2,17
1/4	1800	115	48	AUTO	HG121	5KH32FN3123X	✓	\$249	F1	5.1	15	9.92	3,17
	1800	115	48	NONE	HG120	5KH32FN3123	✓	\$238	F1	5.1	15	9.92	3,17
	1800	115/230	48	AUTO	C243	5KC32GN9X	✓	\$294	F1	5.4/2.7	17	10.00	2,17
	1800	115/230	48	NONE	C242	5KC32GN9	✓	\$281	F1	5.4/2.7	17	10.00	2,17
	1800	230	48	AUTO	H243	5KH32GN68X	✓	\$272	F1	2.7	17	9.92	3,17
	1500	110/220	48	NONE	C462	5KC33KN19	✓	\$325	F1	5.4/2.7	18	10.17	2,17,50
	1800	115/208-230	56	MANUAL	G314	56C17F2052	✓	\$235	F1	4.2/2.1-2.1	20	10.22	2,18
	1800	115/230	56	AUTO	CG251	5KC32GN19X	✓	\$306	F1	5.4/2.7	17	10.38	2,17
	1800	115/230	56	NONE	G1312	5KC32GN19	✓	\$219	F1	5.4/2.7	16	10.38	2,17
	1200	115/230	56	NONE	G1316	5KC49MN6061	✓	\$332	F1	6.2/3.1	27	11.43	2,17
1/3	3600	115	48	AUTO	HG124	5KH33FN85X	✓	\$260	F1	6.4	16	10.17	3,17
	3600	115	48	NONE	HG123	5KH33FN85	✓	\$252	F1	6.4	16	10.17	3,17
	1800	115/230	56	AUTO	G1331	5KC35MN43X	✓	\$255	F1	6.0/3.0	20	10.93	2,18
	1800	115/208-230	56	MANUAL	G332	56C17F2049	✓	\$270	F1	6.0/3.0-3.0	20	10.47	2,18
	1800	100-120/200-400	56	NONE	E258	5KCR46JN0089	✓	\$392	F1	4.0-3.8/2.0-1.9	25	11.83	ES,1,20,68
	1800	115/230	56	NONE	G1330	5KC35MN43	✓	\$245	F1	6.0/3.0	17	10.93	2,18
	1200	115/230	56	NONE	C1333	5KC49PN6062	✓	\$374	F1	8.6/4.3	31	12.43	2,18
	1/2	3600	115/208-230	56	MANUAL	G393	56C34F5307	✓	\$228	F1	8.4/4.0-4.2	22	11.82
3600		115/230	56	MANUAL	C664	5KC36LN4003Y	✓	\$228	F1	8.0/4.0	17	11.36	17,82
3600		115/208-230	56	NONE	K339	56C34F5327	✓	\$213	F1	8.4/4.0-4.2	23	11.82	2,14,18
1800		100-120/200-240	56	NONE	E267	5KCR46MN0094	✓	\$446	F1	5.8-5.6/2.9-2.8	27	11.83	ES,1,19,68
1800		115/230	56	AUTO	C262	5KC42GN0014X	✓	\$293	F1	8.6/4.3	21	11.00	2,18
1800		115/208-230	56	MANUAL	G339	56C17F2051	✓	\$311	F1	8.0/4.0-4.0	23	11.22	2,18
1800		115/208-230	56	MANUAL	C661	5KC46GN0569Y	✓	\$311	F1	9.0/4.5-4.5	44	11.83	18,82
1800		115/208-230	56	NONE	C261	5KC42GN0014	✓	\$276	F1	8.6/4.1-4.3	21	11.00	2,18
1800		115/230	48	NONE	CG260	5KC37RN35	✓	\$361	F1	8.8/4.4	23	11.38	2,17
1200		115/230	56	NONE	C264	5KC49UN6065	✓	\$474	F1	9.4/4.7	40	12.96	2,18
3/4		3600	115/208-230	56	MANUAL	G379	56C34F5309	✓	\$277	F1	10.6/5.3-5.3	26	12.32
	3600	115/208-230	56	NONE	G352	56C34F5308	✓	\$260	F1	10.6/5.3-5.3	26	12.32	2,14,18
	1800	100-120/200-240	56	NONE	EG276	5KCR49PN0101	✓	\$497	F1	9.0-8.8/4.5-4.4	31	12.43	ES,7,19,68
	1800	115/230	56	AUTO	C269	5KC46PN0015X	✓	\$359	F1	11.0/5.5	31	11.83	2,17
	1800	115/208-230	56	MANUAL	G356	56C17F5308	✓	\$382	F1	11.0/5.4-5.5	29	12.32	2,14,18
	1800	115/208-230	56	NONE	C268	5KC46PN0015	✓	\$340	F1	11.0/5.4-5.5	31	11.83	2,18
	1200	115/230	56	NONE	C271	5KCR48WN6066	✓	\$566	F1	10.6/5.3	44	13.82	ES,1,17
	1200	115/208-230	143T	NONE	I707	143TBFR5376	✓	\$591	S1	11.4/5.8-5.7	42	13.87	1,14,18

SINGLE PHASE



General Purpose, Single Phase

Totally Enclosed

Rigid Base

HP	RPM	VOLTS	FRAME	OVER LOAD	CAT. NO.	MODEL NO.	STOCK	LIST PRICE	MULT. SYMB.	F.L. AMPS	WEIGHT	"C" DIM.	FOOT NOTES
1	3600	115/208-230	56	NONE	G359	56C34F5310	✓	\$298	F1	12.4/6.7-6.2	30	12.32	2,14,18
	3600	115/230	56	AUTO	C273	5KC49NN2130X	✓	\$313	F1	13.0/6.5	29	12.43	2,17
	3600	115/230	56	MANUAL	C663	5KC49NN2419Y	✓	\$313	F1	13.2/6.6	29	12.43	19,82
	3600	115/208-230	56	MANUAL	G390	56C34F5311	✓	\$313	F1	12.4/6.7-6.2	31	12.32	2,14,18
	3600	115/230	56	MANUAL	C274	5KC49NN2130Y	✓	\$313	F1	13.0/6.5	21	12.43	2,17
	1800	115/230	56	MANUAL	C660	5KC49TN0568Y	✓	\$400	F1	13.2/6.6	38	12.96	17,82
	1800	115/230	56	NONE	C275	5KC49TN0034	✓	\$383	F1	13.2/6.6	38	12.96	2,17
	1800	100-120/200-240	56	NONE	E285	5KCR49UN0108	✓	\$571	F1	11.8-11.4/5.9-5.7	40	12.96	ES,1,68
	1800	115/208-230	56	MANUAL	G373	56C17F5311	✓	\$400	F1	13.4/6.8-6.7	30	12.82	2,14,18
	1800	115/230	56	AUTO	C276	5KC49TN0034X	✓	\$392	F1	13.2/6.6	36	12.96	2,17
1 1/2	3600	115/208-230	56H	MANUAL	G391	56B34F5321	✓	\$410	F1	14.2/7.7-7.1	33	12.82	1,5,14,18
	3600	115/230	56	MANUAL	C662	5KC49SN2418U	✓	\$410	F1	16.4/8.2	35	12.96	17,82
	3600	115/208-230	56H	NONE	G374	56B34F5320	✓	\$382	F1	14.2/7.7-7.1	32	12.82	1,5,14
	3600	115/208-230	143T	NONE	I220	143TBFR5301	✓	\$424	S1	14.2/7.7-7.1	33	12.87	1,14,18
	1800	115/208-230	56H	MANUAL	C659	5KCR48WN0566Y	✓	\$459	F1	14.5/7.1-7.3	40	13.82	18,82
	1800	115/208-230	56H	MANUAL	G378	56B17F5302	✓	\$459	F1	15.2/8.2-7.6	40	13.82	1,5,14,18
	1800	115/208-230	56H	NONE	G1376	5KCR48WN0273	✓	\$436	F1	14.5/7.1-7.3	44	13.82	ES,1,5,18
	1800	115/208-230	56H	AUTO	G1377	5KCR48WN0273X	✓	\$451	F1	14.5/7.1-7.3	44	13.82	ES,1,5,18
	1800	115/208-230	145T	MANUAL	I201	145TBFR5327	✓	\$507	S1	15.2/8.2-7.6	41	13.87	1,14,18
	1800	115/208-230	145T	NONE	C297	5KCR48WN0292	✓	\$450	S1	14.5/7.1-7.3	44	14.07	1,18
2	3600	115/230	56	MANUAL	G1392	5KCR49TN2139U	✓	\$464	F1	17.8/8.9	38	14.27	ES,1,18
	3600	115/208-230	56H	NONE	K350	56B34F5322		\$447	F1	18.0/10.0-9.0	38	13.32	1,5,14,18
	3600	115/208-230	145T	NONE	I221	145TBFR5303	✓	\$464	S1	18.0/10.0-9.0	39	13.37	1,14,18
	1800	115/230	145T	NONE	I700	145TBFR5334	✓	\$567	S1	18.8/9.4	50	14.87	1,14,18
	1800	115/208-230	182T	NONE	I212	182TBFR5326	✓	\$613	S1	20.0/10.8-10.0	52	15.65	F,1,18
3	3600	115/208-230	182T	NONE	I206	182TBFR5301	✓	\$714	S1	24.6/13.9-12.3	57	15.81	1,17
	3600	208-230	145T	NONE	I204	145TBFR5301		\$632	S1	13.1-11.8	50	14.87	1,14,18
	3600	208-230	145T	MANUAL	I205	145TBFR5302		\$680	S1	13.1-11.8	50	14.87	1,14,18
	1800	115/208-230	184T	NONE	I213A	184TBFW17044	✓	\$731	S1	28.4/14.8-14.2	72	14.96	1,13,14,17
5	3600	208-230	184T	NONE	I223A	184TBFW7701	✓	\$912	S1	22.0-19.8	98	16.49	1,13,14,17
	1800	208-230	184T	NONE	I214A	184TBFW7726	✓	\$900	S1	21.5-19.5	103	17.46	1,13,14,18
	1800	208-230	213T	NONE	I216	213TBFW7026	✓	\$971	S1	24.5-22.0	106	18.73	1,14,17
7 1/2	3600	208-230	213T	NONE	I224	213TBFW7001	✓	\$1,224	S1	36.0-32.0	112	20.23	1,14,17,F
	1800	208-230	215T	NONE	I215	215TBFW7026	✓	\$1,195	S1	35.0-30.0	133	21.48	1,14,17
10	3600	208-230	215T	NONE	I225	215TBFW7001	✓	\$1,491	S1	44.0-41.5	141	20.23	1,14,17,F
	1800	230	215T	NONE	I217	215TBFW7027	✓	\$1,533	S1	41.5	144	21.48	1,14,17

SINGLE PHASE

General Purpose, Single Phase

Totally Enclosed

Features:

- Ball bearings mechanically locked on shaft end (excludes 5K models)
- Heavy gauge steel constructions
- Suitable for horizontal or vertical mounting
- Economical split phase or capacitor start designs, as noted
- Will accept brake kits, see Accessory section (except as noted)
- UL Recognized and CSA Certified



C-Face Footless

HP	RPM	VOLTS	FRAME	OVER LOAD	CAT. NO.	MODEL NO.	STOCK	LIST PRICE	MULT. SYMB.	F.L. AMPS	WEIGHT	"C" DIM.	FOOT NOTES
1/6	1800	115	56C	NONE	H244	5KH32EN124	√	\$277	F1	4.0	10	10.30	3,17,24
1/4	1800	115/230	56C	NONE	G1511	5KC32GN25	√	\$231	F1	5.4/2.7	16	10.30	2,17,24
1/3	3600	115/230	56C	NONE	C1419	5KC33FN31	√	\$205	F1	5.6/2.8	14	10.19	18,24
	1800	100-120/200-240	56C	NONE	E256	5KCR46JN0088	√	\$417	F1	4.0-3.8/2.0-1.9	25	11.84	ES,1,20,24,68
	1800	115/230	56C	NONE	G1513	5KC35MN73	√	\$266	F1	6.0/3.0	19	10.93	2,18,24
1/2	3600	115/208-230	56C	NONE	G514	56C34F5322		\$223	F1	8.4/4.0-4.2	23	11.82	2,18
	3600	115/230	56C	AUTO	C349	5KC36LN166X	√	\$319	F1	7.4/3.7	19	11.36	2,18,24
	1800	100-120/200-240	56C	NONE	E265	5KCR46MN0093	√	\$468	F1	5.8-5.6/2.9-2.8	27	11.84	ES,1,19,24,68
	1800	115/230	56C	AUTO	C446	5KC42GN0018X	√	\$375	F1	8.6/4.3	21	11.01	2,18,24
	1800	115/230	56C	NONE	G1515	5KC42GN0018	√	\$307	F1	8.6/4.3	21	11.01	2,18,24
	1200	115/230	56C	NONE	C1404	5KC49UN6067	√	\$644	F1	9.4/4.7	40	12.93	2,17,24
3/4	3600	115/208-230	56C	NONE	G516	56C34F5323	√	\$273	F1	10.6/5.3-5.3	26	12.32	2,18
	1800	100-120/200-240	56C	NONE	E274	5KCR49PN0100	√	\$517	F1	9.0-8.8/4.5-4.4	31	12.44	ES,1,19,24,68
	1800	115/230	56C	NONE	G1517	5KC46PN0032	√	\$369	F1	11.0/5.5	31	11.84	2,17,24
1	3600	115/208-230	56C	NONE	G518	56C34F5324	√	\$309	F1	12.4/6.7-6.2	29	12.32	2,18
	3600	115/230	56C	AUTO	C351	5KC49NN2133X	√	\$407	F1	13.0/6.5	29	12.44	2,18,24
	1800	100-120/200-240	56C	NONE	EG283	5KCR49UN0107	√	\$593	F1	11.8-11.4/5.9-5.7	40	12.97	ES,1,18,24,68
	1800	115/230	56C	NONE	G1519	5KC49TN0035	√	\$393	F1	13.2/6.6	36	12.97	2,17,24
1 1/2	3600	115/230	56C	NONE	C1424	5KC49SN2158	√	\$392	F1	16.4/8.2	35	12.93	2,24,111
	3600	115/230	56C	AUTO	C855	5KC49SN2156X	√	\$498	F1	16.4/8.2	35	12.93	2,17,24
	1800	115/208-230	56C	NONE	G1531	5KCR48WN0294	√	\$454	F1	14.5/7.1-7.3	44	13.69	ES,1,18,24
2	3600	115/208-230	56C	NONE	G533	56B34F5319	√	\$476	F1	18.0/10.0-9.0	38	13.32	1,18
	3600	115/230	56C	AUTO	C466	5KCR49TN2155T	√	\$610	F1	17.8/8.9	38	14.28	1,17,24

SINGLE PHASE

General Purpose, Single Phase

Totally Enclosed

Features:

- Ball bearings mechanically locked on shaft end (excludes 5K models)
- Heavy gauge steel constructions
- Suitable for horizontal or vertical mounting
- Economical split phase or capacitor start designs, as noted
- Will accept brake kits, see Accessory section (except as noted)
- Service Factor, as noted
- UL Recognized and CSA Certified



C-Face Footed (Rigid Base)

HP	RPM	VOLTS	FRAME	OVER LOAD	CAT. NO.	MODEL NO.	STOCK	LIST PRICE	MULT. SYMB.	F.L. AMPS	WEIGHT	"C" DIM.	FOOT NOTES	
1/4	1200	115/230	56C	NONE	C1423	5KC49MN6063	✓	\$356	F2	6.2/3.1	10	11.4	24,68	
1/3	1800	100-120/200-240	56C	AUTO	E257	5KCR46JN0087X	✓	\$434	F1	4.0-3.8/2.0-1.9	23	11.84	ES,1,20,24,68	
	1800	100-120/200-240	56C	MANUAL	E255	5KCR46JN0087Y	✓	\$437	F1	4.0-3.8/2.0-1.9	26	11.84	ES,1,20,24,68	
	1800	115/208-230	56C	MANUAL	F131	56C17F5358	✓	\$347	F1	6.6/3.1-3.3	23	11.82	2,18,68	
	1800	115/230	56C	NONE	C1405	5KC35MN145	✓	\$270	F1	6.0/3.0	17	10.93	2,24,18,68	
1/2	3600	115/208-230	56C	NONE	C1420	5KC36LN144	✓	\$228	F1	7.4/3.7	17	11.36	2,24,19,68	
	3600	115/230	56C	AUTO	C444	5KC36LN144X	✓	\$235	F2	7.4/3.7	25	11.36	24,68	
	1800	100-120/200-240	56C	MANUAL	E264	5KCR46MN0055Y	✓	\$484	F1	5.8-5.6/2.9-2.8	29	11.84	ES,1,19,24,68	
	1800	100-120/200-240	56C	AUTO	E266	5KCR46MN0055X	✓	\$472	F1	5.8-5.6/2.9-2.8	29	11.84	ES,1,19,24,68	
1/2	1800	115/208-230	56C	MANUAL	F132	56C17F5912	✓	\$388	F1	8.8/4.2-4.4	25	11.82	2,18,68	
	1800	115/230	56C	NONE	C375	5KC42GN0066	✓	\$311	F1	8.6/4.3	23	11.01	2,18, 24,68	
	3/4	1800	100-120/200-240	56C	MANUAL	EG273	5KCR49PN0099Y	✓	\$540	F1	9.0-8.8/4.5-4.4	31	12.44	ES,1,19,24,68
		1800	100-120/200-240	56C	AUTO	E275	5KCR49PN0099X	✓	\$530	F1	9.0-8.8/4.5-4.4	31	12.44	ES,1,19,24,68
3/4	1800	115/208-230	56C	MANUAL	F133	56C17F5913	✓	\$451	F1	11.5/4.5-5.5	29	12.32	2,18,68	
	1800	115/230	56C	NONE	C1425	5KC49PN0283	✓	\$374	F1	11.0/5.5	31	12.40	2,17,24,68	
	1200	115/230	56C	NONE	C1412	5KCR49WN6078		\$605	F2	12.6/6.3	44	13.81	ES,1,24,68	
	1	3600	115/230	56C	AUTO	C445	5KC49NN2132X	✓	\$321	F2	13.0/6.5	29	12.44	24,68
1800		100-120/200-240	56C	MANUAL	EG282	5KCR49UN0106Y	✓	\$615	F1	11.8-11.4/5.9-5.7	40	12.97	ES,1,18,24,68	
1800		100-120/200-240	56C	AUTO	EG284	5KCR49UN0106X	✓	\$610	F1	11.8-11.4/5.9-5.7	40	12.97	ES,1,18,24,68	
1800		115/208-230	56C	NONE	C376	5KC49TN0067	✓	\$400	F1	13.2/6.7-6.6	38	12.97	2,17,24,68	
1800		115/208-230	56C	MANUAL	F134	56C17F5914	✓	\$485	F1	13.4/6.8-6.7	31	12.82	2,18,68	
1 1/2	3600	115/208-230	56HCZ	NONE	K631	56B34F5324		\$397	F1	14.2/7.7-7.1	34	12.82	1,18,68	
	1800	115/208-230	56C	MANUAL	F135	56B17F5584	✓	\$583	F1	15.2/8.2-7.6	41	13.82	1,5,18,68	
	1800	115/208-230	145TC	NONE	C281	145TBFR5337		\$567	S1	15.2/8.2-7.6	43	13.87	1,18,68	
2	3600	115/208-230	145TC	NONE	C282	145TBFR5305		\$632	S1	16.6/9.1-8.3	42	13.37	1,18,68	
	1800	115/230	56HC	MANUAL	K319	56B17F5319	✓	\$598	F1	18.8/9.4	50	14.82	1,5,18,68	
3	3600	208-230	145TC	NONE	C284	145TBFR5306		\$678	S1	13.1-11.8	52	14.87	1,18,68	
	1800	230	184TC	MANUAL	I314A	184TBFW7041	✓	\$896	S1	12.8	86	17.61	1,13,18,68	
5	1800	230	184TC	MANUAL	I315A	184TBFW7034	✓	\$1,069	S1	21	101	18.72	1,13,17,68	

SINGLE PHASE

General Purpose, Single Phase Totally Enclosed

Features:

- Double sealed ball bearings, mechanically locked on shaft end
- Heavy gauge steel constructions
- Bolt-on, removable rigid base
- Suitable for horizontal or vertical mounting
- Capacitor start design for high starting torque
- Capacitor start/capacitor run design for higher efficiency, as noted
- 1.15 Service Factor (except as noted)
- Will accept brake kits, see Accessory section
- Will accept drip cover kits, see Accessories section
- UL Recognized and CSA Certified



C-Face Footed (Removable Base)

HP	RPM	VOLTS	FOUR-N ONE	FRAME	OVER LOAD	CAT. NO.	MODEL NO.	STOCK	LIST PRICE	MULT. SYMB.	F.L. AMPS	WEIGHT	"C" DIM.	FOOT NOTES
1/4	1200	115/208-230	YES	56C	NONE	G577	56C11F5302	✓	\$356	F2	6.8/3.1-3.4	24	11.82	
1/3	1800	115/208-230	YES	56C	NONE	G570	56C17F5320	✓	\$277	F2	6.6/3.1-3.3	23	11.82	68
	1200	115/208-230	YES	56C	NONE	G576	56C11F5303	✓	\$397	F2	7.8/3.6-3.9	27	12.32	
1/2	3600	115/208-230	YES	56C	NONE	D311	56C34F5301	✓	\$235	F2	8.4/4.0-4.2	22	11.82	
	1800	115/208-230	YES	56C	NONE	G571	56C17F5321	✓	\$317	F2	8.8/4.2-4.4	24	11.82	68
	1200	115/208-230	YES	56C	NONE	G578	56B11F5303	✓	\$484	F2	9.6/4.7-4.8	35	13.32	1,68
3/4	3600	115/208-230	YES	56C	NONE	D312	56C34F5302	✓	\$284	F2	10.6/5.3-5.3	27	12.32	
	1800	115/208-230	YES	56C	NONE	G572	56C17F5322	✓	\$382	F2	11.0/5.4-5.5	30	12.32	68
	1200	115/208-230	YES	56C	NONE	G579	56B11F5302	✓	\$605	F2	11.4/5.8-5.7	39	13.82	1
1	3600	115/208-230	YES	56C	NONE	D313	56C34F5303	✓	\$321	F2	11.2/5.7-5.6	30	12.32	
	1800	115/208-230	YES	56HC	NONE	G573	56C17F5323	✓	\$406	F2	13.4/6.8-6.7	31	12.82	5,68
1 1/2	3600	115/208-230	YES	56C	NONE	D314	56B34F5326	✓	\$404	F2	14.2/7.7-7.1	32	12.82	1
	1800	115/208-230	YES	56HC	NONE	G574	56B17F5305	✓	\$466	F2	15.2/8.2-7.6	40	13.82	1,5,68
2	3600	115/208-230	YES	56HC	NONE	D315	56B34F5327	✓	\$486	F2	16.6/9.1-8.3	37	13.82	1,5
	1800	115/208-230	YES	56HC	NONE	G575	56B17F5306	✓	\$584	F2	20.0/10.8-10.0	51	14.82	1,5,17
3	3600	208-230	YES	56HC	NONE	D316	56B34F5328	✓	\$650	F2	13.1-11.8	50	14.82	1,5

SINGLE PHASE

Hazardous Duty™ Division 1 Explosion Proof Class I and II, Groups C (as noted), D, F & G Steel Frame, Single Phase

Features:

- 1.0 Service Factor
- Automatic reset thermal protector
- Meets temperature code T3B
- Economical split phase or capacitor start designs, as noted
- UL Listed File No. E12044
- CSA Certified File No. LR47504



Resilient Base

HP	RPM	VOLTS	FRAME	GROUP C	CAT. NO.	MODEL NO.	STOCK	LIST PRICE	MULT. SYMB.	F.L. AMPS	WEIGHT	"C" DIM.	FOOT NOTES
1/4	1800	115	56	N	K032	56C17E5302		\$374	F1	4.8	26	11.88	2,N
	1200	115	56	N	K033	56C11G5303	✓	\$514	F1	5.4	31	14.46	2,37
1/3	1800	115	56	N	K037	56C17G5308		\$489	F1	6.6	29	13.96	2,37



Rigid Base

HP	RPM	VOLTS	FRAME	GROUP C	CAT. NO.	MODEL NO.	STOCK	LIST PRICE	MULT. SYMB.	F.L. AMPS	WEIGHT	"C" DIM.	FOOT NOTES
1/12	1800	115	48	N	H454	5KH32ENB168X	✓	\$451	F1	1.90	18	9.68	3,N
1/8	1200	115	48	N	HG455	5KH36NNB166X	✓	\$511	F1	3.00	23	10.74	3,N
1/6	1800	115	48	N	HG456	5KH35LNB164X	✓	\$468	F1	3.30	22	10.31	3,N
	1200	115	56	Y	H891	5KC49LN6386X	✓	\$598	F1	3.80	26	12.47	3,N
1/4	1800	115	48	N	HG458	5KH36PNB171X	✓	\$484	F1	4.40	24	10.74	3,N
	1800	115/208-230	56	Y	G639	56C17E5314	✓	\$446	F1	4.8/2.3-2.4	26	11.97	2,N
	1800	115/230	48	N	C646	5KC36PNB169X	✓	\$548	F1	4.2/2.1	25	10.74	2,N
	1200	115	56	Y	C1801	5KC49MN6384X	✓	\$713	F1	5.6	34	13.94	2
1/3	1200	115/208-230	56	Y	G650	56C11G5306	✓	\$597	F1	6.8/3.1-3.4	28	13.94	2
	1800	115/208-230	56	Y	G651	56C17G5315	✓	\$509	F1	6.6/3.1-3.3	27	13.44	2
	1500	110/220-230	56	Y	C1803	5KC49HN0719X	✓	\$603	F1	6.8/3.1-3.4	31	13.44	2
	1200	115/208-230	56	Y	G652	56C11G5307	✓	\$641	F1	7.8/3.6-3.9	31	13.94	2
1/2	3600	115/208-230	56	Y	G653	56C34G5308	✓	\$458	F1	8.4/4.0-4.2	26	13.44	2
	1800	115/208-230	56	Y	G654	56C17G5316	✓	\$556	F1	8.8/4.2-4.4	27	13.94	2
	1500	110/220-230	56	Y	C1807	5KC49QN0716X	✓	\$618	F1	8.4/4.2-4.4	33	14.44	2,50
	1200	115/208-230	56	Y	C1809	5KC49SN6375X		\$739	F1	9.4/4.7-5.0	39	14.94	2
3/4	1200	115/208-230	56	Y	G655	56B11G5301	✓	\$739	F1	9.6/4.7-4.8	39	14.94	1
	3600	115/208-230	56	Y	G656	56C34G5309		\$516	F1	10.6/5.3-5.3	31	13.94	2
	1800	115/208-230	56	Y	C1810	5KC49QN4559X	✓	\$624	F1	11.0/5.4-5.5	38	14.44	d,2
	1800	115/208-230	56	Y	G657	56C17G5317	✓	\$624	F1	11.0/5.4-5.5	33	14.44	2
1	3600	115/208-230	56	Y	G658	56C34G5310		\$557	F1	12.4/6.7-6.2	40	14.44	2
	1800	115/208-230	56	Y	G659	56C17G5318	✓	\$652	F1	13.4/6.8-6.7	34	14.44	2

SINGLE PHASE

Hazardous Duty™ Division 1 Explosion Proof Class I and II, Groups C, D, F & G Steel Frame, Single Phase

Features:

- 1.0 Service Factor
- Explosion proof conduit box included, shipped loose
- Automatic reset thermal protector
- Meets temperature code T3B
- UL Listed File No. E12044, MC228275
- 56CZ frame motors have 2-1/4 x 5/8 shaft dimensions
- CSA Certified File No. LR47504, MC236833
- Capacitor start design for high starting torque



C-Face Footless

HP	RPM	VOLTS	FRAME	CAT. NO.	MODEL NO.	STOCK	LIST PRICE	MULT. SYMB.	F.L. AMPS	WEIGHT	"C" DIM.	FOOT NOTES
1/4	1800	115/208-230	56C	G852	56C17E5319	✓	\$463	F1	4.8/2.3-2.4	22	11.97	
	1200	115	56CZ	C1818	5KC49MN6379X	✓	\$667	F1	5.6	34	14.30	2,37
1/3	1800	115/208-230	56C	G853	56C17G5320	✓	\$522	F1	6.6/3.1-3.3	27	13.44	
1/2	3600	115/208-230	56C	G854	56C34G5311	✓	\$470	F1	8.4/4.0-4.2	26	13.44	
	3600	115/208-230	56J	C1814	5KC49HN2509X	✓	\$690	F1	8.4/4.0-4.2	27	13.95	15
	1800	115/208-230	56C	G855	56C17G5321	✓	\$568	F1	8.8/4.2-4.4	28	13.94	
	1200	115	56CZ	C1817	5KC49SN6380X	✓	\$850	F1	8.0	47	15.30	
3/4	1800	115/208-230	56C	C1816	5KC49QN0718X	✓	\$636	F1	11.0/5.4-5.5	27	14.44	d
	1800	115/208-230	56C	G857	56C17G5322	✓	\$636	F1	11.0/5.4-5.5	33	14.44	
1	3600	115/208-230	56C	G858	56C34G5316	✓	\$570	F1	12.4/6.2-6.7	34	14.44	
	1800	115/208-230	56C	G870	56C17G5323	✓	\$664	F1	13.4/6.8-6.7	34	14.44	



SINGLE PHASE

C-Face Footed (Rigid Base)

HP	RPM	VOLTS	FRAME	CAT. NO.	MODEL NO.	STOCK	LIST PRICE	MULT. SYMB.	F.L. AMPS	WEIGHT	"C" DIM.	FOOT NOTES
1/3	1800	115/208-230	56C	G871	56C17G5324	✓	\$501	F1	6.6/3.1-3.3	37	13.44	
1/2	1800	115/208-230	56C	G872	56C17G5328	✓	\$573	F1	8.8/4.2-4.4	29	13.94	
3/4	3600	115/208-230	56C	G873	56C34G5314	✓	\$533	F1	10.6/5.3-5.3	30	13.94	
	1800	115/208-230	56C	G874	56C17G5326	✓	\$641	F1	11.0/5.4-5.5	34	14.44	
1	3600	115/208-230	56C	G875	56C34G5315	✓	\$576	F1	12.4/6.7-6.2	34	14.44	
	1800	115/208-230	56C	G876	56C17G5327	✓	\$680	F1	13.4/6.8-6.7	35	14.44	

General Purpose, Three Phase Dripproof, Rigid Base

Features:

- EISA compliant efficiencies, as noted
- Ball bearings (except where noted)
- NEMA Service Factors
- Will accept C-Face Kits, see Accessories Section (except as noted)
- UL Recognized and CSA Certified
- See XRI® Dripproof in Premium Efficiency section for NEMA Premium efficiencies



Suitable for use on VFD per guidelines on page 17.

HP	RPM	VOLTS	FRAME	OVER LOAD	CAT. NO.	MODEL NO.	STOCK	LIST PRICE	MULT. SYMB.	NOM. EFF.	F.L. AMPS	WEIGHT	"C" DIM.	FOOT NOTES	C-FACE KITS	
1/4	1800	208-230/460	48	NONE	G044	48T17D2000	✓	\$195	F1	62.0	1.2-1.3/65	13	9.34	25,68	N/A	
1/3	3600	208-230/460	48	NONE	K113	5K35FN2	✓	\$187	F1	61.0	1.5-1.8/0.9	14	9.25		N/A	
	1800	208-230/460	48	NONE	K527	5K35JN198	✓	\$227	F1	66.5	1.5-1.6/0.8	15	9.25		N/A	
	1800	200-208	56	NONE	G046	56T17D2128		\$227	F1	67.0	1.8-1.9	15	9.97	25	N/A	
	1800	208-230/460	56	NONE	G047	56T17D2095	✓	\$227	F1	67.0	1.5-1.6/0.8	15	9.97	25,68	N/A	
	1200	208-230/460	56	NONE	G061	56T11D5301		\$309	F1	62.0	1.9-2.2/1.1	19	9.94	68	A435	
1/2	3600	208-230/460	56	NONE	K027	56T34D5300		\$207	F1	66.0	2.1-2.2/1.1	20	10.44	68	A435	
	3600	208-230/460	48	NONE	K115	5K36JN2	✓	\$207	F1	69.8	2.0-2.0/1.0	16	9.68		N/A	
	1800	200-208	56	NONE	G062	56T17D2114	✓	\$255	F1	70.0	2.5-2.65	17	10.47	25	N/A	
	1800	208-230/460	56	NONE	G063	56T17D2094	✓	\$262	F1	70.0	2.1-2.2/1.1	17	10.47	25,68,CF	N/A	
	1800	208-230/460	56	NONE	K116	5K42HN4106	✓	\$254	F1	74.7	2.3-2.2/1.1	19	10.05	19	A534	
	1800	208-230/460	56	NONE	E12D4	5KS49HN4077	✓	\$369	F1	76.9	1.8-1.8/0.9	20	10.38	ES	A534	
	1800	208-230/460	56	AUTO	G905	56T17D5336	✓	\$316	F1	68.0	2.3-2.4/1.2	21	10.44	VC,68	A435	
	1800	575	56	NONE	G065	56T17D2112	✓	\$255	F1	70.0	0.9	17	10.47	25	N/A	
	1500	220/380	56	NONE	K318	5K42JN4163	✓	\$352	F1	66.7	3.0/1.7	21	10.05	50	A534	
	1200	208-230/460	56	NONE	G067	56T11D5302	✓	\$342	F1	68.0	2.4-2.7/1.35	23	10.44	68	A435	
3/4	900	208-230/460	143T	NONE	H180	143TTDR5401		\$416	E6	64.0	2.9-3.0/1.5	32	11.49	5,13	A436	
	3600	208-230/460	56	NONE	G080	56T34D5301	✓	\$231	F1	74.0	3.0-3.2/1.6	21	10.44	68	A435	
	1800	200-208	56	NONE	G082	56T17D2111	✓	\$285	F1	75.5	3.2-3.3	21	10.97	25	N/A	
	1800	208-230/460	56	NONE	G084	56T17D2093	✓	\$305	F1	75.5	2.7-2.8/1.4	20	10.97	25,68,CF	N/A	
	1800	208-230/460	56	NONE	K119	5K46KN4071	✓	\$295	F1	74.3	3.3-3.0/1.5	24	10.78	19	A534	
	1800	208-230/460	56	AUTO	G908	56T17D5339	✓	\$346	F1	75.5	2.9-3.0/1.5	22	10.44	68	A435	
	1800	200-230/460	56	NONE	E34D4	5KS46MN4078	✓	\$414	F1	79.2	2.5-2.4/1.2	24	10.78	ES,68	A534	
	1800	575	56	NONE	G086	56T17D2110	✓	\$285	F1	75.5	1.1	20	10.97	25	A435	
	1200	208-230/460	56	NONE	G088	56T11D5303	✓	\$353	F1	74.0	3.1-3.2/1.6	25	10.94	d,68	A435	
	1200	208-230/460	143T	NONE	H150	143TTDR5376	✓	\$321	E6	74.0	3.1-3.2/1.6	29	10.99	5,68	A436	
	900	208-230/460	145T	NONE	H181	145TTDR5401	✓	\$472	E6	72.0	4.0-4.0/2.0	42	12.99	68	A436	
	1	3600	208-230/460	56	NONE	K000	56T34D5302	✓	\$263	F1	74.0	3.7-3.7/1.85	23	10.44		A435
		1800	200	143T	NONE	E901	143TTDR5348	✓	\$297	E2	82.5	3.6	40	12.49	5,13	A436
1800		200-208	56	NONE	K003	56T17D2113	✓	\$293	F1	76.5	3.9-4.1	23	11.47	25	N/A	
1800		200-208	143T	NONE	H601	143TTDR5327	✓	\$263	E6	77.0	4.15-4.3	27	10.99	d,5,13	A436	
1800		200-208	143T	AUTO	U416	143TTDR4061	✓	\$423	E2	82.5	3.6-3.43	39	12.49	5,13	A436	
1800		208-230/460	56	NONE	K004	56T17D2092	✓	\$310	F1	76.5	3.4-3.4/1.7	23	11.47	25,68,CF	N/A	
1800		208-230/460	56	NONE	K122	5K46MN4072	✓	\$300	F1	79.2	3.6-3.8/1.9	27	10.78	19	A534	
1800		208-230/460	56	NONE	K2069	5KE49PN4594	✓	\$417	F1	82.5	3.2-3.1/1.55	30	11.38		A534	
1800		208-230/460	56	AUTO	G921	56T17D5342	✓	\$353	F1	77.0	3.5-3.6/1.8	24	10.94	VC,68	A436	
1800		208-230/460	56HZ	AUTO	K063	56T17D3301	✓	\$375	F1	77.0	3.5-3.6/1.8	27	10.99	Z,5,68	A436	
1800		208-230/460	56HZ	AUTO	K067	56T17D3305		\$389	F1	77.0	3.5-3.6/1.8	27	10.99	VC,Z,5,68	A436	
1800		208-230/460	143T	NONE	E715	143TTDR5347	✓	\$297	E2	82.5	3.3-3.1/1.55	39	12.49	d,5,13,68	A436	
1800		208-230/460	143T	AUTO	U417	143TTDR4052	✓	\$423	E2	82.5	3.3-3.1/1.55	39	12.49	d,5,13,68	A436	

Catalog numbers (Cat No.) highlighted in bold blue have efficiency levels that meet EISA requirements

Continued on next page.

General Purpose, Three Phase

Dripproof, Rigid Base



HP	RPM	VOLTS	FRAME	OVER LOAD	CAT. NO.	MODEL NO.	STOCK	LIST PRICE	MULT. SYMB.	NOM. EFF.	F.L. AMPS	WEIGHT	"C" DIM.	FOOT NOTES	C-FACE KITS	
1	1800	208-230/460	143T	AUTO	U417A	143TTDR6052	✓	\$495	E2	85.5	3.2-3.0/1.5	45	12.99	5,13,68	A436	
	1800	208-230/460	143T	AUTO	U418	143TTDR4051	✓	\$440	E2	82.5	3.3-3.1/1.55	38	12.49	d,VC,5,13,68	A436	
	1800	208-230/460	143T	AUTO	U418A	143TTDR6051	✓	\$515	E2	85.5	3.2-3.0/1.5	45	12.99	VC,5,13,68	A436	
	1800	575	56	NONE	K049	56T17D2130	✓	\$293	F1	76.5	1.4	24	11.47	25	N/A	
	1800	575	56HZ	AUTO	K081	56T17D15528		\$375	F1	77.0	1.45	27	10.99	Z,5	A436	
	1800	575	143T	AUTO	U922	143TTDR4055		\$423	E2	82.5	1.1	39	12.49	5,13	A436	
	1800	575	143T	AUTO	U922A	143TTDR16036		\$495	E2	85.5	1.2	45	12.99	5,13	A436	
	1200	200	145T	NONE	E785	145TTDR4078		\$389	E2	80.0	4.1	47	13.49	5,13	A436	
	1200	208-230/460	56H	NONE	K007	56T11D5304		\$382	F1	75.5	4.1-4.2/2.1	29	11.44	5,68	A435	
	1200	575	145T	NONE	E934	145TTDR4080		\$389	E2	80.0	1.4	47	13.49	5,13	A435	
	900	230/460	182T	NONE	H182A	182TTDW7101		\$511	E6	75.8	4.0/2.0	69	12.19	13	A666	
	1 1/2	3600	200	143T	NONE	E917	14TTDR4005		\$330	E2	82.5	5.5	31	10.90	5,13	A436
3600		208-230/460	56	NONE	K009	56T34D5303	✓	\$324	F1	80.0	4.9-5.0/2.5	24	10.44	68	A435	
3600		208-230/460	143T	NONE	E783	143TTDR5313	✓	\$330	E2	82.5	4.2-4.2/21	31	10.99	d,5,13,68	A436	
3600		208-230/460	143T	NONE	E783A	143TTDR6313	✓	\$452	E2	86.5	4-3.8/1.9	101	12.49	5,13,68	A436	
3600		575	143T	NONE	E798	143TTDR4006		\$330	E2	82.5	1.9	28	10.99	5,13	A436	
1800		200	145T	NONE	E902	145TTDR5632	✓	\$324	E2	84.0	5.0	39	12.49	5,13	A436	
1800		200-208	145T	AUTO	U419	145TTDR4128	✓	\$450	E2	84.0	5.0-4.9	39	12.49	5,13	A436	
1800		208-230/460	56H	NONE	K022	56T17D5309	✓	\$325	F1	80.0	4.8-4.8/2.4	28	10.94	5,68	A436	
1800		208-230/460	56H	AUTO	G923	56T17D5344	✓	\$386	F1	80.0	4.8-4.8/2.4	27	10.94	VC,5,68	A436	
1800		208-230/460	56HZ	AUTO	K064	56T17D3302	✓	\$398	F1	80.0	4.8-4.8/2.4	30	10.99	Z,5,68	A436	
1800		208-230/460	56HZ	AUTO	K068	56T17D3306	✓	\$408	F1	80.0	4.8-4.8/2.4	33	10.99	VC,Z,5,68	A436	
1800		208-230/460	145T	AUTO	U420A	145TTDR6126	✓	\$526	E2	86.5	4.4-4.4/2.2	48	12.49	5,13,68	A436	
1800		208-230/460	145T	AUTO	U421A	145TTDR6127		\$546	E2	86.5	4.4-4.4/2.2	48	12.49	VC,5,13,68	A436	
1800		575	56H	NONE	K061	56T17D5369	✓	\$325	F1	80.0	1.9	27	10.94	5	A436	
1800		575	145T	AUTO	U923	145TTDR4130		\$450	E2	84.0	1.8	39	12.49	5,13	A436	
1800		575	145T	AUTO	U923A	145TTDR16054		\$553	E2	86.5	1.8	47	12.99	5,13	A436	
1500		220/380	145T	NONE	K408	5K49SN8050	✓	\$456	E2	81.7	4.5/2.6	35	13.59	50	A536	
1200		200	182T	NONE	E1799	182TTDW4083	✓	\$428	E2	84.0	7.2	75	12.69	13	A666	
900		230/460	184T	NONE	H183A	184TTDW7101		\$620	E6	77.0	5.6/2.8	62	13.19	13	A666	
2		3600	200	145T	NONE	U905	145TTDR4103		\$389	E2	84.0	6.2	29	10.99	5,13	A436
		3600	208-230/460	56H	NONE	K025	56T34D5304	✓	\$382	F1	80.0	6.4-6.2/3.1	24	10.44	5,68	A435
	3600	575	145T	NONE	U906	145TTDR4005		\$389	E2	84.0	2.2	31	10.99	5,13	A436	
	1800	200-208	145T	NONE	E903	145TTDR5633	✓	\$357	E2	84.0	6.7-6.6	43	12.99	5,13	A436	
	1800	200-208	145T	AUTO	U422	145TTDR4134	✓	\$485	E2	84.0	6.7-6.6	43	12.99	5,13	A436	
	1800	208-230/460	56H	NONE	K041	56T17D5310	✓	\$357	F1	81.5	6.2-6.2/3.1	33	11.94	5,68	A436	
	1800	208-230/460	56HZ	AUTO	K065	56T17D3303	✓	\$427	F1	81.5	6.2-6.2/3.1	35	11.99	Z,5,68	A436	
	1800	208-230/460	56HZ	AUTO	K069	56T17D3307	✓	\$440	F1	81.5	6.2-6.2/3.1	34	11.99	VC,Z,5,68	A435	
	1800	208-230/460	145T	AUTO	U423A	145TTDR6132		\$568	E2	86.5	6.2-6.0/3.0	56	12.49	5,13,68	A436	
	1800	208-230/460	145T	AUTO	U424A	145TTDR6133		\$588	E2	86.5	6.2-6.0/3.0	56	12.99	VC,5,13,68	A436	
	1800	575	56H	NONE	K062	56T17D5370	✓	\$357	F1	81.5	2.5	33	11.94	5	A435	
	1800	575	145T	NONE	E914	145TTDR5665	✓	\$357	E2	84.0	2.3	43	12.99	d,5,13	A436	
	1800	575	145T	NONE	E914A	145TTDR16062	✓	\$547	E2	86.5	2.4	37	13.62	A600		
	1800	575	145T	AUTO	U924	145TTDR4136		\$485	E2	84.0	2.3	42	12.99	5,13	A436	
	1800	575	145T	AUTO	U924A	145TTDR16059		\$568	E2	86.5	2.4	56	13.49	5,13	A436	
	1200	200	184T	NONE	E918	184TTDR4178		\$549	E2	85.5	7.15	89	15.22	13,25	A666	
	900	230/460	213T	NONE	H184A	213TTDW14102		\$877	E2	85.5	8.0/4.0	142	17.30	A606		
	3	3600	200	145T	NONE	E919	145TTDR4003		\$408	E2	84.0	10.0	33	11.49	5,13	A436
		3600	208-230/460	56H	NONE	K048	56T34D5340		\$424	F1	84.0	8.8-8.2/4.1	32	11.44	5	A436
		3600	575	145T	NONE	E932	145TTDR4105		\$408	E2	84.0	3.5	33	11.49	5,13	A436

GENERAL PURPOSE THREE PHASE

Catalog numbers (Cat No.) highlighted in bold blue have efficiency levels that meet EISA requirements

Continued on next page.



General Purpose, Three Phase

Dripproof, Rigid Base



HP	RPM	VOLTS	FRAME	OVER LOAD	CAT. NO.	MODEL NO.	STOCK	LIST PRICE	MULT. SYMB.	NOM. EFF.	F.L. AMPS	WEIGHT	"C" DIM.	FOOT NOTES	C-FACE KITS	
3	1800	200	182T	NONE	E1904	182TTDW4027	✓	\$418	E2	86.5	10.1	60	12.69	13,25,CF	A666	
	1800	200-208	182T	AUTO	U1425	182TTDW4074	✓	\$571	E2	86.5	9.6-9.7	62	12.69	13	A666	
	1800	200-208	182T	AUTO	U425B	182TTDW16048		\$668	E2	89.5	9.0-8.9	71	13.19	13	A666	
	1800	208-230/460	56HZ	NONE	H803	56T17D5398	✓	\$389	F1	84.0	9.2-8.6/4.3	47	13.49	Z,13,68	A436	
	1800	208-230/460	56HZ	AUTO	K066	56T17D3304	✓	\$436	F1	84.0	9.2-8.6/4.3	47	13.49	Z,5,68	A436	
	1800	208-230/460	56HZ	AUTO	K080	56T17D3308	✓	\$450	F1	84.0	9.2-8.6/4.3	47	13.99	VC,Z,5,68	A436	
	1800	208-230/460	182T	AUTO	U426B	182TTDR16049	✓	\$668	E2	89.5	8.6-8.0/4.0	72	13.19	13	A666	
	1800	575	182T	NONE	E1915	182TTDW4030	✓	\$418	E2	86.5	3.5	60	12.69	d,13	A666	
	1800	575	182T	AUTO	U925	182TTDR4075		\$571	E2	86.5	3.5	78	14.22	d, 25	N/A	
	1800	575	182T	AUTO	U925A	182TTDW16082		\$668	E2	89.5	3.2	87	14.19	13,25	A666	
	1200	200	213T	NONE	U907	213TTDW4078	✓	\$743	E2	86.5	9.65	121	17.30		A606	
	900	230/460	215T	NONE	H185A	215TTDW14110		\$1,096	E2	86.5	10.0/5.0	225	18.55		A606	
5	3600	200	182T	NONE	E933	182TTDR4104		\$468	E2	86.5	13.8	74	13.72	25	N/A	
	3600	575	182T	NONE	U908	182TTDR4106		\$468	E2	85.5	4.8	83	13.72	25	N/A	
	1800	200	184T	NONE	E1905	184TTDW4027	✓	\$454	E2	87.5	15.6	79	13.19	13	A666	
	1800	200-208	184T	AUTO	U427	184TTDR4153	✓	\$647	E2	87.5	15.0/14.4	76	15.22	d,25	N/A	
	1800	200-208	184T	AUTO	U427A	184TTDW4153	✓	\$647	E2	87.5	15.0/14.7	77	13.19	13	A666	
	1800	208-230/460	184T	AUTO	U428B	184TTDW16038	✓	\$756	E2	89.5	13.6-12.6/6.3	75	14.19	13,68	A666	
	1800	575	184T	NONE	E1916	184TTDW4030	✓	\$454	E2	87.5	5.3	79	13.19	13	A666	
	1800	575	184T	AUTO	U917	184TTDW16041		\$647	E2	89.5	5.1	82	14.19	13	A666	
	1200	200	215T	NONE	E935	215TTDW4078	✓	\$865	E2	87.5	16.1	145	18.55	13	A606	
	900	230/460	254T	NONE	H186A	254TTDX14104	✓	\$1,515	E2	87.5	17.6/8.8	133	20.57	22,32	A612	
	7 1/2	3600	200	184T	NONE	E937A	184TTDW4003		\$606	E2	87.5	20.3	68	14.19	13,25	A666
		3600	575	184T	NONE	E938	184TTDR4105		\$606	E2	87.5	7.0	78	14.72		A666
1800		200	213T	NONE	E906	213TTDBA4028	✓	\$632	E2	88.5	24.9	114	17.30	13,25	A606	
1800		200-208	213T	AUTO	U429	213TTDW4070		\$921	E2	88.5	22.1-21.2	118	18.04	13	A606	
1800		208-230/460	213T	AUTO	U430A	213TTDW16060	✓	\$1,078	E2	91.0	21.0-19.2/9.6	135	19.29	13,68	A606	
1800		575	213T	NONE	E758	213TTDW4030	✓	\$632	E2	88.5	7.7	113	17.30	d,13	A606	
1800		575	213T	AUTO	U926	213TTDW4071		\$921	E2	88.5	7.7	118	17.30	d,13	A606	
1800		575	213T	AUTO	U926A	213TTDW16061		\$1,078	E2	91.0	7.7	125	19.29	13	A606	
900		230/460	256T	NONE	H187	256TTDX7101	✓	\$1,790	E6	84.0	26.0/13.0	148	22.32	d	A612	
900		230/460	256T	NONE	H187A	256TTDN14102	✓	\$1,925	E2	88.5	22.0/11.0	162	24.37		N/A	
10		3600	200	213T	NONE	E939	213TTDW4003		\$787	E2	88.5	26.9	120	17.30	13	A606
		1800	200	215T	NONE	E907	215TTDW4028	✓	\$811	E2	89.5	28.8	125	17.30	13	A606
	1800	575	215T	NONE	E759	215TTDW4030	✓	\$811	E2	89.5	10.0	123	17.30	d,13	A606	
	1200	230/460	256T	NONE	E734	256TTDX4076	✓	\$1,261	E2	90.2	28.0/14.0	178	22.32		A612	
	900	230/460	284T	NONE	H188A	284TTDN14102		\$2,284	E2	89.5	38.5/19.2	328	24.94		A610	
15	3600	200	215T	NONE	E788	215TTDW4003	✓	\$1,210	E2	90.2	39.1	120	18.55	13	A606	
	1800	200	254T	NONE	E908	254TTDX4028	✓	\$1,215	E2	91.0	44.2	208	22.32		A612	
	1800	575	254T	NONE	E760	254TTDX4030	✓	\$1,215	E2	91.0	15.4	184	22.32		A612	
	900	230/460	286T	NONE	H189A	286TTDN14101		\$3,003	E2	89.5	42.0/21.0	361	26.81		A610	
20	3600	200	254T	NONE	U900	254TTDX4018		\$1,426	E2	91.0	53.1	214	20.57		A612	
	1800	200	256T	NONE	E909	256TTDX4027	✓	\$1,484	E2	91.0	60.0	227	22.32		A612	
	1800	575	256T	NONE	E761	256TTDX4032	✓	\$1,484	E2	91.0	20.8	198	22.32	d	A612	
25	3600	200	256T	NONE	H627	256TTDX7024	✓	\$1,412	E6	89.5	70.0	360	22.32	d	A612	
	3600	200	256T	NONE	E786	256TTDX4013	✓	\$1,740	E2	91.0	66.5	200	22.32		A612	
	1800	200	284T	NONE	E910	284TTDP4029	✓	\$1,723	E2	91.7	70.0	350	23.49		A610	
	1800	200	284T	NONE	H628	284TTDP7644	✓	\$1,397	E6	88.5	76.0	340	23.49	d	A610	
	1800	575	284T	NONE	E762	284TTDP4035	✓	\$1,723	E2	91.7	24.4	351	23.49	d	A610	
900	230/460	326T	NONE	H191A	326TTDR14105		\$4,283	E2	90.2	73.0/36.5	565	28.50		A613		

Catalog numbers (Cat No.) highlighted in bold blue have efficiency levels that meet EISA requirements

Blue shaded areas are Cast Iron Frames

Continued on next page.

GENERAL PURPOSE THREE PHASE

General Purpose, Three Phase

Dripproof, Rigid Base

HP	RPM	VOLTS	FRAME	OVER LOAD	CAT. NO.	MODEL NO.	STOCK	LIST PRICE	MULT. SYMB.	NOM. EFF.	F.L. AMPS	WEIGHT	"C" DIM.	FOOT NOTES	C-FACE KITS
30	3600	200	284TS	NONE	U901	284TSTDP4004		\$2,076	E2	91.0	83.0	320	22.06		A610
	1800	200	286T	NONE	E911	286TTDP4027	✓	\$2,004	E2	92.4	83.0	350	24.99		A610
	1800	200	286T	NONE	H632	286TTDP7641	✓	\$1,631	E6	89.5	91.0	367	24.99	d	A610
	1800	575	286T	NONE	E763	286TTDP4034		\$2,004	E2	92.4	28.8	285	24.99		A610
	1200	230/460	326T	NONE	E738	326TTDP4076	✓	\$3,020	E2	92.4	82.0/41.0	483	27.50	d	A613
40	3600	200	286TS	NONE	U902	286TSTDP4017		\$2,658	E2	91.7	108	460	23.56		A610
	1800	200	324T	NONE	E787	324TTDP4030		\$2,493	E2	93.0	112	542	26.00		A613
	1800	200	324T	NONE	H636	324TTDP7649	✓	\$2,034	E6	89.5	122	510	26.00	d	A613
	1800	230/460	324TS	NONE	E789	324TSTDP4032	✓	\$2,493	E2	93.0	97.0/48.5	457	24.50	d	A613
	1800	575	324T	NONE	E764	324TTDP4028		\$2,493	E2	93.0	39.0	474	26.00		A613
50	1200	230/460	364T	NONE	E746	364TTDS4086	✓	\$4,226	E2	93.0	105/52.5	718	28.62	d	A216
	3600	200	324TS	NONE	U909	324TSTDP4006		\$3,158	E2	92.4	135	385	24.50		A613
	1800	200	326T	NONE	E790	326TTDP4046		\$2,906	E2	93.0	142	499	27.50		A613
	1800	230/460	326T	NONE	E727	326TTDC4026	✓	\$2,906	E2	93.0	123/61.5	550	27.50	d,68	A613
	1800	230/460	326TS	NONE	E791	326TSTDP4036	✓	\$2,906	E2	93.0	123/61.5	495	26.00	d,68	A613
60	1800	575	326T	NONE	E765	326TTDP4048	✓	\$2,906	E2	93.0	49.0	496	27.50	d	A613
	3600	200	326TS	NONE	U910	326TSTDP4003		\$3,591	E2	93.0	155	398	26.00		A613
	1800	230/460	364T	NONE	E739	364TTDC4036	✓	\$3,562	E2	93.6	142/71.0	797	28.62	d	A216
	1800	230/460	364T	NONE	E1739	364TTDCA4036	✓	\$3,562	E2	93.6	2.0	797	31.69	d	A167
	1800	230/460	364TS	NONE	E768	364TSTDC4026	✓	\$3,562	E2	93.6	142/71.0	887	26.50	d, 68	A216
75	1800	230/460	364TS	NONE	E1768	364TSTDCA4026	✓	\$3,562	E2	93.6	2.0	887	29.57	d	A167
	1800	575	364T	NONE	E766	364TTDS4040		\$3,562	E2	93.6	57.5	699	28.62	d	A216
	1200	230/460	404T	NONE	E748	404TTDS4086	✓	\$5,621	E2	93.6	143/71.5	1135	32.50	d,68	A222
	3600	230/460	364TS	NONE	E714	364TSTDS4001	✓	\$4,787	E2	93.0	183/91.5	740	26.50	d,68	A219
	1800	230/460	365T	NONE	E1740	365TTDCA4036	✓	\$4,338	E2	94.1	2.0	997	33.27	d	A167
100	1800	230/460	365TS	NONE	E1782	365TSTDCA4026	✓	\$4,338	E2	94.1	2.0	979	31.14	d	A167
	1800	575	365T	NONE	E767	365TTDS4041		\$4,338	E2	94.1	71.0	730	29.62		A216
	100	1800	575	404T	NONE	U903	404TTDS4042		\$5,532	E2	94.1	94.5	1004	32.50	
125	3600	460	404TS	NONE	E754	404TSTDS4001	✓	\$7,381	E2	93.6	142	917	29.50	d,PW	A225
	1800	460	405T	NONE	E742	405TTDS4036	✓	\$6,624	E2	94.5	147	1087	34.00	d,PW	A222
	1800	575	405T	NONE	U904	405TTDS4049		\$6,624	E2	94.5	118	1083	34.00		A222
150	3600	460	405TS	NONE	E755	405TSTDS4001	✓	\$9,515	E2	93.6	169	1028	31.00	d,PW	A225
	1800	460	444T	NONE	E743	444TTDS4036	✓	\$9,566	E2	95.0	176	1335	37.75	d,PW	A228
	1800	575	444T	NONE	U911	444TTDS4069		\$9,566	E2	95.0	141	1321	37.75		A228
200	3600	460	444TS	NONE	E756	444TSTDS4001	✓	\$12,437	E2	94.5	225	1310	34.00	d,PW	A231
	1800	575	445T	NONE	U912	445TTDS4070		\$12,085	E2	95.0	186	1447	39.75		A228
250	3600	460	445TS	NONE	E757	445TSTDS4001	✓	\$17,697	E2	94.5	279	1406	36.00	PW,68	A231
	1800	460	445T	NONE	E745	445TTDS4037		\$14,420	E2	95.4	287	1561	39.75	PW,RB	A228
	1200	460	447T	NONE	H822A	447TTDN14087		\$15,156	E2	95.4	308	2345	43.25	F,RB,YD,25	N/A
300	3600	460	447TS	NONE	H178	447TSTDN7001	✓	\$16,918	E6	95.0	332	1940	39.50	F,YD,68	A293
	1800	460	447TS	NONE	H812	447TSTDN7026	✓	\$15,976	E6	95.4	345	1994	39.50	F,YD,68	A293
	1200	460	449T	TSTAT	H820	449TTDN7086		\$16,360	E6	95.4	357	2632	48.25	F,YD,17,25	N/A
350	3600	460	447TS	NONE	H193	447TSTDN7003	✓	\$19,379	E6	95.0	385	2013	39.50	F,YD,68	A293
	1800	460	447TS	NONE	H813	447TSTDN7027	✓	\$17,363	E6	95.4	400	2064	39.50	F,YD,68	A293
	1200	460	449T	TSTAT	H821A	449TTDN14078		\$23,628	E2	95.4	420	2145	48.25	F,YD,17,25	N/A
400	3600	460	447TS	NONE	H817	447TSTDN7005	✓	\$22,049	E6	95.4	440	2150	39.50	F,YD,68	A293
	1800	460	447TS	NONE	H814	447TSTDN7028	✓	\$20,152	E6	95.4	450	2220	39.50	F,YD	A293
450	3600	460	449TS	TSTAT	H818	449TSTDN7001	✓	\$23,550	E6	95.8	502	2544	44.50	F,YD,68	A293
	1800	460	449TS	TSTAT	H815A	449TSTDN14033		\$23,169	E6	95.8	505	2695	44.50	F,YD	A293
500	3600	460	449TS	TSTAT	H819A	449TSTDN14005	✓	\$28,591	E6	95.8	546	2737	44.50	F,YD	A293
	1800	460	449TS	TSTAT	H816	449TSTDN7027		\$23,599	E6	95.8	560	2695	44.50	F,YD	A293

GENERAL PURPOSE THREE PHASE

Catalog numbers (Cat No.) highlighted in bold blue have efficiency levels that meet EISA requirements

Blue shaded areas are Cast Iron Frames



General Purpose, Three Phase Dripproof

Features:

- Ball bearings, mechanically locked on shaft end
- NEMA Service Factors
- UL Recognized and CSA Certified



C-Face Footless

Suitable for use on VFD per guidelines on page 17.

HP	RPM	VOLTS	FRAME	CAT. NO.	MODEL NO.	STOCK	LIST PRICE	MULT. SYMB.	NOM. EFF.	F.L. AMPS	WEIGHT	"C" DIM.	FOOT NOTES
1/4	1800	208-230/460	56C	K247	5K49DN4132	✓	\$205	F1	67.4	1.1-1.2/0.6	17	9.52	17,68
1/3	3600	208-230/460	56C	KG215	5K35FN55	✓	\$177	F1	61.0	1.5-1.8/0.9	14	9.90	68,115
	1800	208-230/460	56C	K248	5K49FN4138	✓	\$237	F1	69.2	1.5-1.6/0.8	20	9.52	68
1/2	3600	208-230/460	56C	K216	5K36JN57	✓	\$201	F1	69.8	2.0-2.0/1.0	16	10.31	68,114
	1800	208-230/460	56C	K249	5K42HN4127	✓	\$267	F1	74.7	2.3-2.2/1.1	19	9.90	68
	1800	575	56C	G242	56T17D2115	✓	\$267	F1	68.0	0.9	17	10.30	
3/4	3600	208-230/460	56C	G205	56T34D5327		\$242	F1	74.0	3.0-3.2/1.6	20	10.44	68
	3600	208-230/460	56C	K218	5K37MN37	✓	\$242	F1	74.0	2.6-2.6/1.3	17	10.70	48,68,113
	1800	208-230/460	56C	K250	5K46KN4125	✓	\$298	F1	74.3	2.7-2.8/1.4	24	10.80	
	1800	575	56C	G243	56T17D2116	✓	\$298	F1	75.5	1.1	19	10.80	d
	1200	208-230/460	56C	K1300	5K49PN6019	✓	\$365	F1	76.1	2.9-2.8/1.4	26	11.38	
1	3600	208-230/460	56C	K220	5K38PN47	✓	\$257	F1	74.0	3.3-3.2/1.6	36	11.30	48,68,112
	1800	208-230/460	56C	K251	5K46MN4126	✓	\$284	F1	79.2	3.6-3.8/1.9	24	10.73	
	1800	208-230/460	143TC	K634	5K46MN8423	✓	\$334	E6	79.2	3.6-3.8/1.9	27	12.42	d
	1800	208-230/460	143TC	K634A	143TTDR14049	✓	\$384	E2	82.5	3.3-3.1/1.55	34	12.49	
	1800	575	56C	G244	56T17D2127		\$304	F1	77.0	1.4	23	11.30	
	1200	208-230/460	145TC	C150A	145TTDR14088	✓	\$475	E2	80.0	3.8-3.6/1.8	43	13.49	68
1 1/2	3600	208-230/460	56C	K222	5K46KN2173	✓	\$335	F1	80.0	5.0-4.8/2.4	24	10.73	48,68,111
	3600	208-230/460	143TC	K2018	5KE49PN8418	✓	\$417	E6	82.5	4.4-4.0/2.0	35	11.50	
	1800	208-230/460	56C	K521	5K49PN4120	✓	\$336	F1	79.8	5.8-5.6/2.8	31	11.33	
	1800	208-230/460	145TC	K622	5K49RN8424	✓	\$383	E6	82.1	5.2/2.6	33	11.95	d
	1800	208-230/460	145TC	K622A	145TTDR14049	✓	\$412	E2	84.0	4.6-4.4/2.2	41	12.49	
	1200	208-230/460	145TC	C162A	145TTDR14087		\$497	E2	84.0	5.45-5.4/2.7	51	12.49	68
2	3600	208-230/460	145TC	C102A	145TTDR14007	✓	\$475	E2	84.0	5.4/2.7	34	10.99	68
	3600	208-230/460	56C	K224	5K49NN2180	✓	\$392	F1	80.0	6.0-6.0/3.0	27	11.33	48,68,110
	1800	208-230/460	56C	K644	5K49ZN4611	✓	\$369	F1	83.8	6.6-6.4/3.2	49	13.81	
	1800	208-230/460	145TC	C122A	145TTDR4341	✓	\$444	E2	84.0	6.2-5.8/2.9	42	11.99	68
	1800	208-230/460	145TC	K2043	5KE49UN8428	✓	\$483	E6	84.0	6.4-6.0/3.0	40	12.62	24,68
	1200	230/460	184TC	C152A	184TTDW14078		\$572	E2	85.5	6.8/3.4	28	13.28	13,68
3	3600	208-230/460	56C	G289	56T34D5339		\$440	F1	84.0	8.9-8.4/4.2	31	11.44	68
	3600	208-230/460	56C	K226	5K48TN2182	✓	\$440	F1	84.0	8.9-8.4/4.2	38	12.61	18,48,68
	3600	208-230/460	145TC	C103	145TTDR5312	✓	\$485	E6	84.0	8.9-8.4/4.2	32	11.49	68
	1800	208-230/460	182TC	C123	182TTDR8067	✓	\$494	E6	81.5	9.2-9.0/4.5	67	14.28	d,68
	1800	208-230/460	182TC	C1123	182TTDW8067	✓	\$494	E6	82.5	9.2-9.0/4.5	55	12.28	d,13,68
	1800	208-230/460	182TC	C123B	182TTDW4028	✓	\$531	E2	86.5	9-8.8/4.4	63	12.78	13,68
5	3600	208-230/460	182TC	C104B	182TTDW14008	✓	\$662	E2	85.5	14.0-12.4/6.2	65	13.73	13,68
	1800	208-230/460	184TC	C124B	184TTDW14027	✓	\$580	E2	87.5	13.2/6.6	87	13.28	13,68
7 1/2	3600	208-230/460	184TC	C105B	184TTDW14017	✓	\$758	E2	87.5	20.0-17.6/8.8	74	14.28	13,68
	1800	208-230/460	213TC	C125A	213TTDW14057		\$767	E2	88.5	21.0-19.0/9.5	148	18.03	68
	1200	208-230/460	254TC	C155A	254TTDX14089		\$1,233	E2	88.5	23.0-21.4/10.7	217	20.92	68
10	3600	208-230/460	213TC	C106A	213TTDW14014	✓	\$934	E2	88.5	26.0-23.4/11.7	105	18.03	68
	1800	208-230/460	215TC	C126A	215TTDW14071		\$930	E2	89.5	28.0-25.0/12.5	124	18.03	68
	1200	230/460	256TC	C156A	256TTDX14087		\$1,398	E2	90.2	28.0/14.0	201	22.67	68

GENERAL PURPOSE THREE PHASE

General Purpose, Three Phase Dripproof

Applications:

General purpose use on gear reducers, pumps, machine tools, and other direct coupled equipment installed in environments that are relatively clean and dry. For use outdoors an enclosure or drip cover may be required (see Accessories section).



Features:

- Ball bearings, mechanically locked on shaft end (excludes 5K models)
- NEMA Service Factors
- UL Recognized and CSA Certified



C-Face Footed (Rigid Base)

Suitable for use on VFD per guidelines on page 17.

HP	RPM	VOLTS	FRAME	CAT. NO.	MODEL NO.	STOCK	CT SPEED RANGE*	LIST PRICE	MULT. SYMB.	NOM. EFF.	F.L. AMPS	WEIGHT	"C" DIM.	FOOT NOTES
1/3	1800	208-230/460	56C	K1305	5K42FN4033	✓	-----	\$259	F1	69.2	1.5-1.6/0.8	17	9.95	
1/2	3600	208-230/460	56C	K1306	5K49FN2045	✓	-----	\$245	F1	65.5	2.2-2.5/1.3	19	10.38	114
	1800	208-230/460	56C	K1307	5K42HN4032	✓	-----	\$289	F1	74.7	2.3-2.2/1.1	19	9.95	68
3/4	1800	208-230/460	56C	K1308	5K46KN4031	✓	-----	\$320	F1	74.3	3.3-3.0/1.5	24	10.78	
1	1800	208-230/460	143TC	K2021	5KE49PN8391	✓	-----	\$347	E2	82.5	3.2-3.1/1.55	34	11.50	d
	1800	208-230/460	56HC	K635	5K46MN4623	✓	-----	\$325	F1	79.2	3.6-3.8/1.9	27	10.78	
1 1/2	3600	208-230/460	56C	K690	5K46HN2546	✓	-----	\$356	F1	80.0	5.2-5.0/2.5	22	10.44	
	1800	208-230/460	145TC	K2022	5KE49TN8401	✓	-----	\$356	E2	84.0	4.5-4.4/2.2	39	12.03	
2	1800	208-230/460	56HC	K646	5K49RN4617	✓	-----	\$357	F1	82.1	5.2/2.6	33	11.91	
	3600	208-230/460	56C	K1311	5K49NN2046	✓	-----	\$414	F1	80.5	6.6-6.0/3.0	27	11.38	
2	1800	208-230/460	145TC	K2023	5KE49UN8407	✓	-----	\$401	E2	84.0	6.4-6.0/3.0	42	13.34	
	1800	208-230/460	56HC	K648	5K49ZN4616	✓	-----	\$390	F1	83.6	6.2-5.8/2.9	49	13.86	
	5	3600	208-230/460	182TC	U402B	182TTDW14012	✓	2:1	\$749	E2	86.5	13.4-12.0/6.0	72	14.20
5	3600	208-230/460	182TC	U402C	182TTDW16010	✓	2:1	\$788	E2	86.5	13.4-12.4/6.2	65	13.20	68
	1800	230/460	184TC	U403A	184TTDW16043		2:1	\$771	E2	89.5	13.6-12/6.3	89	14.20	13,68
	7 1/2	3600	208-230/460	184TC	U404B	184TTDW16001		2:1	\$1,061	E2	88.5	17.8/8.9	85	14.20
10	1800	230/460	213TC	U405	213TTDW4045	✓	2:1	\$896	E2	88.5	19.2/9.6	155	18.03	d,68
	1800	230/460	213TC	U405A	213TTDW16063	✓	2:1	\$1,048	E2	91.0	16.2/8.1	168	18.03	68
10	3600	230/460	213TC	U432A	213TTDW16010		2:1	\$1,083	E2	89.5	23.4/11.7	127	18.03	YD,68
	1800	208-230/460	215TC	U433	215TTDW4335	✓	2:1	\$1,066	E2	89.5	28.0-25.0/12.5	172	18.03	d,YD,68
	1800	208-230/460	215TC	U433A	215TTDW16061		2:1	\$1,246	E2	91.7	27.0-25.0/12.5	185	19.28	YD,68
15	3600	230/460	215TC	U435	215TTDW4315		2:1	\$1,349	E2	90.2	34.0/17.0	128	19.28	YD,13,68
	1800	208-230/460	254TC	U436	254TTDX4065	✓	2:1	\$1,404	E2	91.0	42.0-38.5/19.2	185	22.64	d,YD,68
	1800	208-230/460	254TC	U436A	254TTDN16056	✓	2:1	\$1,641	E2	93.0	37.0/18.5	221	23.31	YD,68
20	3600	230/460	254TC	U437	254TTDX4315		2:1	\$1,615	E2	91.0	46.0/23.1	200	20.89	YD,68
	1800	208-230/460	256TC	U438A	256TTDN16049		2:1	\$1,955	E2	93.0	59.0-55.0/27.5	235	24.81	YD,68
25	3600	230/460	256TC	U439	256TTDX4315		2:1	\$1,928	E2	91.0	58.0/29.0	185	22.64	d,YD,68
	3600	230/460	256TC	U439A	256TTDN16009		2:1	\$2,255	E2	91.7	58.0/29.0	243	24.81	YD,68
	1800	230/460	284TSC	U440A	286TSTDN16034		2:1	\$2,365	E2	93.6	61.0/30.5	356	14.50	YD,68
30	3600	230/460	284TSC	U441A	286TSTDN16005	✓	2:1	\$2,780	E2	91.7	67.5/34	234	25.44	YD,68
	1800	230/460	286TSC	U442A	286TSTDN16033		2:1	\$2,694	E2	94.1	73.0/36.5	376	25.44	YD,68
40	3600	230/460	286TSC	U443A	286TSTDN16004		2:1	\$3,458	E2	92.4	90.0/45.0	354	25.44	YD,68
	1800	230/460	324TSC	U444A	324TSTDP16032		-----	\$3,418	E2	94.1	94.0/47.0	465	24.50	YD,68
50	3600	230/460	324TSC	U445	324TSTDP4016	✓	-----	\$3,589	E2	92.4	117/58.5	420	24.50	d,YD,68
	3600	230/460	324TSC	U445A	324TSTDP16002	✓	-----	\$4,196	E2	93.0	112/56.0	443	24.50	YD,68
60	1800	230/460	326TSC	U446A	326TSTDR16035		-----	\$3,901	E2	94.5	121/60.5	453	27.00	YD,68
	3600	230/460	326TSC	U447A	326TSTDP16005	✓	-----	\$4,703	E2	93.6	135/67.5	366	26.00	YD,68
75	1800	230/460	364TSC	U448A	365TSTDS16044		-----	\$4,894	E2	95.0	139/69.5	748	26.50	YD,68
	3600	230/460	364TSC	U449A	365TSTDS16008		-----	\$6,832	E2	93.6	170/85.0	732	27.50	YD,68
100	1800	230/460	365TSC	U450A	365TSTDS6074		-----	\$5,801	E2	95.0	174/87.0	803	27.50	YD,68
	3600	230/460	365TSC	U451A	365TSTDS16005		-----	\$8,081	E2	93.6	230/115	799	27.50	YD,68
125	1800	230/460	404TSC	U452A	404TSTDS6327		-----	\$7,556	E2	95.4	226/113	1056	29.50	YD,68
	3600	460	404TSC	U453A	404TSTDS16006	✓	-----	\$9,719	E2	94.1	138	991	29.50	YD,68
150	1800	460	405TSC	U454A	405TSTDS16039		-----	\$8,833	E2	95.4	141	1132	29.50	YD,68
	3600	460	405TSC	U455A	405TSTDS16005		-----	\$12,214	E2	94.1	165	1034	31.00	YD,68
1800	460	444TSC	U456A	444TSTDS16034		-----	\$12,379	E2	95.8	170	1376	34.00	YD,13,68	

Catalog numbers (Cat No.) highlighted in bold blue have efficiency levels that meet EISA requirements

Blue shaded areas are Cast Iron Frames

* Requires nameplate modification



General Purpose, Three Phase Dripproof, NEMA Premium® XRI® Efficiency

Applications:

General purpose use on compressors, pumps, conveyors, blowers, and other machinery in environments that are relatively clean and dry. Substantial energy savings can be realized when using these high efficiency motors. Guaranteed efficiencies offer an eXtra Return on your Investment when using these premium efficiency motors on high cycle or long run time applications.



Features:

Meets or exceeds NEMA Premium® efficiencies

NEMA Premium® models are in compliance with EISA2007

- Motors are suitable for 10:1 VT on all frame sizes and 10:1 CT up to 365T frame (Except where noted)
- 1.15 Service Factor
- TSTATS available from Mod Central
- Class F Insulation
- Nameplated 60/50 hertz
- UL Recognized, CSA Certified and CE Marked
- Three year warranty



Rigid Base

Suitable for use on VFD per guidelines on page 17.

HP	RPM	VOLTS	FRAME	CAT. NO.	MODEL NO.	STOCK	LIST PRICE	MULT. SYMB.	NOM. EFF.	F.L. AMPS	WEIGHT	"C" DIM.	FOOT NOTES	C FACE KIT
1	3600	208-230/460	56H	U244	56T17D6001	✓	\$406	E2	80.0	2.8-3.4/1.4	24	10.18	13	A435
	1800	208-230/460	143T	U758	143TTDR6027	✓	\$463	E2	85.5	3.2/1.6	30	12.12		A600
	1800	575	143T	E912A	143TTDR16037	✓	\$463	E2	85.5	1.3	30	12.12		A600
	1200	208-230/460	145T	U265	145TTDR6076	✓	\$539	E2	82.5	3.8-4.4/2.2	41	12.62		A600
	1200	575	145T	E934A	145TTDR16077	✓	\$539	E2	82.5	1.8	41	12.62		A600
1 1/2	3600	208-230/460	143T	U245	143TTDR6028	✓	\$452	E2	84.0	4.4-4.0/2.0	36	12.28		A600
	3600	575	143T	E798A	143TTDR16005	✓	\$452	E2	84.0	1.6	36	12.28		A600
	1800	208-230/460	145T	U759	145TTDR6028	✓	\$483	E2	86.5	4.8-5.6/2.4	35	12.62		A600
	1800	575	145T	E913A	145TTDR16061	✓	\$483	E2	86.5	1.8	35	12.62		A600
	1200	208-230/460	182T	U1266	182TTDW6076	✓	\$634	E2	86.5	6.2/3.1	68	13.19	13	A666
2	1200	575	182T	U914	182TTDW16009	✓	\$634	E2	86.5	2.5	68	13.19	13	A666
	3600	208-230/460	145T	U246	145TTDR6039	✓	\$533	E2	85.5	5.2-4.8/2.4	43	13.12		A436
	3600	575	145T	U906A	145TTDR16008	✓	\$533	E2	85.5	2.1	43	13.12		A436
	1800	208-230/460	145T	U760	145TTDR6029	✓	\$547	E2	86.5	5.8/2.9	37	13.62		A600
	1800	575	145T	E914A	145TTDR16062	✓	\$547	E2	86.5	2.4	37	13.62		A600
3	1200	208-230/460	184T	U1267	184TTDW6076	✓	\$646	E2	87.5	7.2/3.6	90	15.19	13	A666
	1200	575	184T	U915	184TTDW16076	✓	\$646	E2	87.5	2.9	90	15.19	13	A666
	3600	208-230/460	145T	U247	145TTDR6002	✓	\$539	E2	86.5	8.0-7.2/3.6	45	13.12		A600
	3600	575	145T	E932A	145TTDR16010	✓	\$539	E2	86.5	2.9	45	13.12		A600
	1800	208-230/460	182T	E1930	182TTDW6030	✓	\$561	E2	89.5	8.4-8.0/4.0	76	14.19	13	A666
5	1800	575	182T	E915B	182TTDW16029	✓	\$561	E2	89.5	3.4	76	14.19	13	A666
	1200	208-230/460	213T	U268	213TTDC6076	✓	\$886	E2	88.5	10.2-10.0/5.0	156	16.38		A602
	1200	575	213T	U279	213TTDC6079	✓	\$886	E2	88.5	4.0	156	16.38		A602
	3600	208-230/460	182T	U1248	182TTDW6001	✓	\$591	E2	86.5	13.0-12.0/6.0	86	15.19	13	A666
	3600	575	182T	U908A	182TTDW16008	✓	\$591	E2	86.5	5.6	86	15.19	13	A666
5	1800	208-230/460	184T	E1931	184TTDW6031	✓	\$631	E2	89.5	13.6-12.8/6.4	89	15.19	13	A666
	1800	575	184T	E916B	184TTDW16040	✓	\$631	E2	89.5	5.3	89	15.19	13	A666
	1200	208-230/460	215T	U269	215TTDC6076	✓	\$1,031	E2	90.2	15.8-15.0/7.5	185	16.38		A602
	1200	575	215T	U280	215TTDC6079	✓	\$1,031	E2	90.2	6.0	185	16.38		A602

Catalog numbers (Cat No.) highlighted in bold blue have efficiency levels that meet EISA requirements

Blue shaded areas are Cast Iron Frames

Continued on next page.

General Purpose, Three Phase Dripproof, NEMA Premium® XRI® Efficiency Rigid Base

HP	RPM	VOLTS	FRAME	CAT. NO.	MODEL NO.	STOCK	LIST PRICE	MULT. SYMB.	NOM. EFF.	F.L. AMPS	WEIGHT	"C" DIM.	FOOT NOTES	C FACE KIT	
7 1/2	3600	208-230/460	184T	U249A	184TTDW6001	√	\$855	E2	88.5	19.6-17.6/8.8	106	16.19	13	A666	
	3600	575	184T	E938A	184TTDW16027	√	\$855	E2	88.5	7.0	106	16.19	13	A666	
	1800	208-230/460	213T	U763	213TTDC6026	√	\$817	E2	91.0	20.6-19.8/9.9	160	16.38		A602	
	1800	575	213T	U281	213TTDC6029	√	\$817	E2	91.0	7.8	160	16.38		A602	
	1200	208-230/460	254T	U254	254TTDC6076	√	\$1,289	E2	92.4	23.4-22.4/11.2	281	20.94	YD	A622	
	1200	575	254T	U282	254TTDC6079	√	\$1,289	E2	92.4	8.1	281	20.94	YD	A622	
10	3600	208-230/460	213T	U764	213TTDC6001	√	\$932	E2	91.0	25.0-23.6/11.8	150	16.38		A602	
	3600	575	213T	U283	213TTDC6003	√	\$932	E2	91.0	9.4	150	16.38		A602	
	1800	208-230/460	215T	U765	215TTDC6026	√	\$964	E2	91.7	28.5-25.6/12.8	220	17.87		A602	
	1800	575	215T	U284	215TTDC6029	√	\$964	E2	91.7	10.0	220	17.87	A	A602	
1200	208-230/460	256T	U255	256TTDC6076	√	\$1,607	E2	91.7	31.0-29.6/14.8	305	22.60	YD	A622		
	575	256T	U285	256TTDC6079	√	\$1,607	E2	91.7	10.8	305	22.60	YD	A622		
	15	3600	208-230/460	215T	U766	215TTDC6001	√	\$1,366	E2	91.0	38.0-34.6/17.3	184	17.87	99	A602
		3600	575	215T	U286	215TTDC6003	√	\$1,366	E2	91.0	13.8	184	17.87	99	A602
1800	208-230/460	254T	U767	254TTDC6026	√	\$1,335	E2	93.0	40.5-37.0/18.5	310	20.94	A,YD	A622		
	575	254T	U287	254TTDC6029	√	\$1,335	E2	93.0	15.0	310	20.94	A,YD	A622		
	1200	208-230/460	284T	U256	284TTDC6076	√	\$2,116	E2	92.4	42.0-39.5/19.7	414	23.54	YD	A626	
	1200	575	284T	U288	284TTDC6079	√	\$2,116	E2	92.4	16.0	414	23.54	YD	A626	
20	3600	208-230/460	254T	U768	254TTDC6001	√	\$1,574	E2	93.0	50.0-46.0/23.0	300	20.94	YD	A622	
	3600	575	254T	U289	254TTDC6003	√	\$1,574	E2	93.0	18.4	300	20.94	YD	A622	
	1800	208-230/460	256T	U769	256TTDC6026	√	\$1,653	E2	93.0	55.0-51.0/25.5	360	22.60	YD	A622	
	1800	575	256T	U290	256TTDC6029	√	\$1,653	E2	93.0	19.2	360	22.60	YD	A626	
1200	208-230/460	286T	U257	286TTDC6076	√	\$2,577	E2	92.4	58.0-55.0/27.5	457	25.00	YD	A626		
	25	3600	208-230/460	256T	U770	256TTDC6001	√	\$2,004	E2	93.0	64.0-57.4/28.7	315	22.60	YD	A622
		3600	575	256T	U291	256TTDC6003	√	\$2,004	E2	93.0	23.0	315	22.60	YD	A626
	1800	208-230/460	284T	U771	284TTDC6026	√	\$1,950	E2	93.6	66.0-59.6/29.8	424	23.54	YD	A626	
1800	208-230/460	284TS	E793A	284TSTDN16031		\$1,950	E2	93.6	64.0/32.0	424	23.57		A287		
1800	575	284T	E762A	284TTDC6029	√	\$1,950	E2	93.6	23.8	424	23.54	YD	A627		
1200	208-230/460	324T	U798	324TTDC6076	√	\$3,070	E2	93.0	72.0-67.0/33.5	695	26.02	YD	A627		
30	3600	208-230/460	284TS	U772	284TSTDC6001	√	\$2,479	E2	94.1	85.0-67.0/33.5	396	22.17	YD	A626	
	3600	575	284TS	U292	284TSTDC6003	√	\$2,479	E2	94.1	28.1	396	22.17	YD	A626	
	1800	208-230/460	286T	U773	286TTDC6026	√	\$2,250	E2	94.1	78.0-71.0/35.5	483	25.00	YD	A626	
	1800	208-230/460	286TS	E794A	286TSTDN16036		\$2,250	E2	94.1	78.0-71.0/35.5	483	25.44		A287	
1800	575	286T	E763A	286TTDC6029	√	\$2,250	E2	94.1	28.6	483	25.00	YD	A627		
1200	208-230/460	326T	U799	326TTDC6076	√	\$3,599	E2	93.6	86.3-78.0/39.0	760	27.52	YD	A627		
40	3600	208-230/460	286TS	U774	286TSTDC6001	√	\$2,984	E2	93.6	100-91.2/45.6	452	23.62	A,YD,99	A626	
	3600	575	286TS	U293	286TSTDC6003	√	\$2,984	E2	93.6	36.5	452	23.62	A,YD,99	A626	
	1800	208-230/460	324T	U775	324TTDC6026	√	\$2,828	E2	94.1	130-118/59.0	581	26.02	YD	A627	
	1800	208-230/460	326TS	E789A	326TSTDP16032	√	\$2,828	E2	94.1	100/50.0	581	26.00		A613	
1800	575	324T	E764A	324TTDC6029	√	\$2,828	E2	94.1	38.0	581	26.02	YD	A627		
1200	208-230/460	364T	U1927	364TTDCA6086	√	\$4,619	E2	94.1	107-100/50.0	875	31.60	YD	A626		
50	3600	208-230/460	324TS	U776	324TSTDC6001	√	\$3,638	E2	94.1	123-112/56.0	548	24.53	YD	A627	
	3600	575	324TS	U294	324TSTDC6003	√	\$3,638	E2	94.1	44.8	548	24.53	YD	A627	
	1800	208-230/460	326T	U777	326TTDC6026	√	\$3,369	E2	94.5	129-118/59.0	710	27.52	YD	A627	
	1800	208-230/460	326TS	E791A	326TSTDN16034	√	\$3,369	E2	94.5	121/60.5	453	27.00		N/A	
1800	575	326TS	E765A	326TTDC6029	√	\$3,369	E2	94.5	48.0	710	27.52	YD	A627		
1200	208-230/460	365T	U1928	365TTDCA6086	√	\$5,317	E2	94.1	134-125/62.5	930	32.80	YD	A629		
60	3600	208-230/460	326TS	U778	326TSTDC6001	√	\$4,352	E2	94.1	148-136/68.0	590	26.02	YD	A627	
	1800	208-230/460	364T	U1779	364TTDCA6060	√	\$4,007	E2	95.4	151.5-140/70.0	1005	31.60	YD	A629	
	1800	208-230/460	365TS	E768C	365TSTDS16042	√	\$4,007	E2	95.4	153-139/69.5	1005	27.50		A219	
	1800	575	365T	E766A	365TTDS16067	√	\$4,007	E2	95.4	55.5	1005	29.62	YD	A216	
1200	230/460	404T	U270	404TTDS6086	√	\$6,400	E2	95.0	146/73.0	975	32.50		A222		

Catalog numbers (Cat No.) highlighted in bold blue have efficiency levels that meet EISA requirements

Blue shaded areas are Cast Iron Frames

Continued on next page.



General Purpose, Three Phase Dripproof, NEMA Premium® XRI® Efficiency

Rigid Base

HP	RPM	VOLTS	FRAME	CAT. NO.	MODEL NO.	STOCK	LIST PRICE	MULT. SYMB.	NOM. EFF.	F.L. AMPS	WEIGHT	"C" DIM.	FOOT NOTES	C FACE KIT
75	3600	208-230/460	364TS	U1782	364TSTDCA6001	✓	\$5,750	E2	93.6	190-170/85.0	937	31.54	YD	A629
	1800	208-230/460	365T	U1783	365TTDCA6060	✓	\$4,799	E2	95.4	189-174/87.0	1030	32.72	YD	A629
	1800	208-230/460	365TS	E782C	365TSTDS16041	✓	\$4,799	E2	95.4	194-174/87.0	1030	27.50		A219
	1800	575	365T	E767A	365TTDS16064		\$4,799	E2	95.0	69.5	1030	29.62	YD	A216
	1200	230/460	405T	U271	405TTDS16081	✓	\$7,866	E2	95.0	180/90.0	1100	34.00		A222
100	3600	208-230/460	365TS	U1784	365TSTDCA6001	✓	\$7,037	E2	94.5	251-224/112	1016	32.72	YD	A629
	1800	230/460	404T	E922	404TTDS6060	✓	\$6,256	E2	95.4	226/113	1025	32.50	YD	A222
	1800	230/460	404TS	E780A	404TSTDS16036	✓	\$6,256	E2	95.4	226/113	1025	29.50		A225
	1800	575	404T	U903A	404TTDS16055		\$6,256	E2	95.4	90.5	1025	32.50	YD	A222
	1200	230/460	444T	U272	444TTDS16077	✓	\$9,764	E2	95.4	234/117	1300	37.75		A228
125	3600	460	404TS	U250	404TSTDS6001	✓	\$8,418	E2	95.0	140	973	29.50	YD	A225
	1800	460	405T	E923	405TTDS6060	✓	\$7,919	E2	95.4	141	1150	34.00	YD	A222
	1800	460	405TS	E781A	405TSTDS16038	✓	\$7,919	E2	95.4	141	1150	31.00	PW	A225
	1800	575	405T	U904A	405TTDS16060		\$7,919	E2	95.4	113	1150	34.00	YD	A222
	1200	460	445T	U273	445TTDS16076	✓	\$12,814	E2	95.0	145	1500	39.75	YD	A228
150	3600	460	405TS	U251	405TSTDS6007	✓	\$10,599	E2	95.0	165	1075	31.00	YD	A225
	1800	460	444T	E924	444TTDS6060	✓	\$10,631	E2	95.8	170	1275	37.75	YD	A228
	1800	460	444TS	E792A	444TSTDS16038	✓	\$10,631	E2	95.8	170	1275	34.00	PW	A231
	1800	575	444T	U911A	444TTDS16043		\$10,631	E2	95.8	170	1275	37.75	YD	A228
	1200	460	447T	U274	447TTDN16077	✓	\$13,175	E2	95.4	185	2050	43.25		N/A
200	3600	460	444TS	U252	444TSTDS16003	✓	\$15,323	E2	95.8	216	1277	34.00	YD	A231
	1800	460	445T	E925	445TTDS6060	✓	\$13,339	E2	95.8	225	1500	39.75	YD	A228
	1800	460	445TS	U400A	445TSTDS16038	✓	\$13,339	E2	95.8	225	1500	36.00	PW	A231
	1800	575	445T	U912A	445TTDS16041		\$13,339	E2	95.8	180	1500	39.75	YD	A228
	1200	460	449T	U275	449TTDN16076	✓	\$15,730	E2	95.4	245	2200	43.25	YD	N/A
250	3600	460	447TS	U785	447TSTDN16004	✓	\$17,846	E2	95.8	274	1438	39.50	YD	A293
	1800	460	447T	U786	447TTDN16046	✓	\$16,478	E2	96.2	292	1438	43.25	YD	N/A
300	3600	460	447TS	U788	447TSTDN16007	✓	\$20,819	E2	95.4	330	1745	39.50	YD	A293
	1800	460	447T	U789	447TTDN16041		\$18,660	E2	96.2	340	1745	43.25	YD	N/A
	1200	460	449T	U790	449TTDN16077		\$24,663	E2	95.8	365	2112	48.25	YD	N/A
350	3600	460	447TS	U791	447TSTDN16008	✓	\$22,900	E2	95.4	385	1745	39.50	YD	A293
400	3600	460	449TS	U793	449TSTDN16003	✓	\$26,471	E2	95.8	450	2112	44.50	YD	A293
450	3600	460	449TS	U795	449TSTDN16004	✓	\$33,459	E2	95.8	495	2112	44.50	YD	A293
500	3600	460	449TS	U797	449TSTDN16005	✓	\$37,275	E2	95.8	545	2147	44.50	YD	A293

Catalog numbers (Cat No.) highlighted in bold blue have efficiency levels that meet EISA requirements

Blue shaded areas are Cast Iron Frames

General Purpose, Three Phase Globetrotter® NEMA Premium® Efficiency Dripproof

Features:

- ⚡ Meets or exceeds NEMA Premium® efficiencies
NEMA Premium® models are in compliance with EISA2007
- 182T-215T models steel frame, 254T-449T models cast iron frame
- Inverter Duty 10:1 Variable Torque and 2:1 Constant Torque, 1.0 SF
- 1.15 Service Factor
- Class F Insulation
- Standard assembly F1, reversible to F2 assembly
- UL Recognized, CSA Certified, CE Mark
- Two year warranty



Rigid Base

HP	RPM	VOLTS	FRAME	CAT. NO.	MODEL NO.	STOCK	LIST PRICE	MULT. SYMB.	NOM. EFF.	F.L. AMPS	WEIGHT	"C" DIM.	FOOT NOTES	C FACE KIT
1 1/2	1200	208-230/460	182T	GT0005	182TTDB6076	✓	\$623	E1	86.5	4.8-4.4/2.2	75	13.72		A160
2	1200	208-230/460	184T	GT0008	184TTDB6076	✓	\$634	E1	87.5	6.4-5.8/2.9	99	14.72		A160
3	1800	208-230/460	182T	GT0010	182TTDB6026	✓	\$551	E1	89.5	8.4-7.8/3.9	76	13.72		A160
	1200	208-230/460	213T	GT0011	213TTDB6076	✓	\$870	E1	88.5	10.2-10.0/5.0	156	17.52		A161
5	3600	208-230/460	182T	GT0012	182TTDB6001	✓	\$581	E1	86.5	13.2-11.8/5.9	126	13.72		A160
	1800	208-230/460	184T	GT0013	184TTDB6026	✓	\$620	E1	89.5	13.6-12.4/6.2	86	14.72		A160
	1200	208-230/460	215T	GT0014	215TTDB6076	✓	\$1,012	E1	89.5	15.2-14.0/7.0	281	17.52		A161
7 1/2	3600	208-230/460	184T	GT0015	184TTDB6001	✓	\$714	E1	88.5	19.0-17.2/8.6	143	14.72	A	A160
	1800	208-230/460	213T	GT0016	213TTDB6026	✓	\$802	E1	91.0	20.7-18.6/9.3	160	17.52		A161
10	1200	208-230/460	254T	GT0017	254TTDCA6076	✓	\$1,266	E1	90.2	21.8-21/10.5	281	22.64		A163
	3600	208-230/460	213T	GT0018	213TTDB6001	✓	\$916	E1	89.5	25.5-23.0/11.5	150	17.52		A161
	1800	208-230/460	215T	GT0019	215TTDB6026	✓	\$947	E1	91.7	26.6-24.4/12.2	220	17.52		A161
15	1200	208-230/460	256T	GT0020	256TTDCA6076	✓	\$1,578	E1	91.7	28.3-26.8/13.4	305	24.22		A163
	3600	208-230/460	215T	GT0021	215TTDB6001	✓	\$1,342	E1	90.2	38.0-34.0/17.0	184	17.52		A161
	1800	208-230/460	254T	GT0022	254TTDCA6026	✓	\$1,311	E1	93.0	40.0-37.0/18.5	310	22.64		A163
20	1200	208-230/460	284T	GT0023	284TTDCA6076	✓	\$2,078	E1	91.7	42.5-40.0/20.0	414	25.71		A165
	3600	208-230/460	254T	GT0024	254TTDCA6001	✓	\$1,546	E1	91.0	50.0-45.5/22.8	300	22.64		A162
	1800	208-230/460	256T	GT0025	256TTDCA6026	✓	\$1,623	E1	93.0	52.5-48.0/24.0	360	24.22		A163
25	1200	208-230/460	286T	GT0026	286TTDCA6076	✓	\$2,532	E1	92.4	56.5-52.5/26.3	457	27.09		A165
	3600	208-230/460	256T	GT0027	256TTDCA6001	✓	\$1,969	E1	91.7	64.0-56.0/28.0	315	24.22		A162
	1800	208-230/460	284T	GT0028	284TTDCA6026	✓	\$1,915	E1	93.6	67.0-62.0/31.0	424	25.71		A165
30	1200	208-230/460	324T	GT0029	324TTDCA6076	✓	\$3,016	E1	93.0	66.0/33.0	695	28.55		A167
	3600	208-230/460	284TS	GT0030	284TSTDCA6001	✓	\$2,435	E1	91.7	74.0-66.5/33.5	396	24.41		A164
	1800	208-230/460	286T	GT0031	286TTDCA6026	✓	\$2,210	E1	94.1	80.0-73.0/36.5	483	27.09		A165
40	1200	208-230/460	326T	GT0032	326TTDCA6076	✓	\$3,535	E1	93.6	83.5-78.5/39.0	760	29.73		A167
	3600	208-230/460	286TS	GT0033	286TSTDCA6001	✓	\$2,931	E1	92.4	99.0-89.0/44.5	452	25.79		A164
	1800	208-230/460	324T	GT0034	324TTDCA6026	✓	\$2,777	E1	94.5	95.0/47.5	581	28.55		A167
50	1200	208-230/460	364T	GT0035	364TTDCB6086	✓	\$4,537	E1	94.1	105-97.0/48.5	875	31.69		A169
	3600	208-230/460	324TS	GT0036	324TSTDCA6001	✓	\$3,573	E1	93.0	122-111/55.5	548	27.05		A166
	1800	208-230/460	326T	GT0037	326TTDCA6026	✓	\$3,310	E1	94.5	118/59.0	710	29.73		A167
60	1200	208-230/460	365T	GT0038	365TTDCB6086	✓	\$5,223	E1	94.1	130-120/60.0	930	33.27		A169
	3600	208-230/460	326TS	GT0039	326TSTDCA6001	✓	\$4,275	E1	93.6	132/66.0	590	28.23		A166
	1800	208-230/460	364T	GT0040	364TTDCB6060	✓	\$3,935	E1	95.0	139/69.5	1005	31.69		A169
	1200	230/460	404T	GT0041	404TTDC6086	✓	\$6,286	E1	94.5	144/72.0	975	37.20		A415

Catalog numbers (Cat No.) highlighted in bold blue have efficiency levels that meet EISA requirements

Blue shaded areas are Cast Iron Frames

GENERAL PURPOSE THREE PHASE



General Purpose, Three Phase Globetrotter® NEMA Premium® Efficiency

Dripproof

Rigid Base

HP	RPM	VOLTS	FRAME	CAT. NO.	MODEL NO.	STOCK	LIST PRICE	MULT. SYMB.	NOM. EFF.	F.L. AMPS	WEIGHT	"C" DIM.	FOOT NOTES	C FACE KIT
75	3600	208-230/460	364TS	GT0042	364TSTD6001	✓	\$5,648	E1	93.6	183-164/82.0	937	29.57		A168
	1800	208-230/460	365T	GT0043	365TTDC6060	✓	\$4,713	E1	95.0	194-174/87.0	1030	33.27		A168
	1200	230/460	405T	GT0044	405TTDC16081	✓	\$7,726	E1	94.5	180/90.0	1100	38.78		A415
100	3600	208-230/460	365TS	GT0045	365TSTD6001	✓	\$6,912	E1	93.6	243-218/109	1016	31.14		A168
	1800	230/460	404T	GT0046	404TTDC6060	✓	\$6,145	E1	95.4	226/113	1025	37.20		A415
	1200	230/460	444T	GT0047	444TTDC16077	✓	\$9,591	E1	95.0	232/116	1675	44.57		A417
125	3600	460	404TS	GT0048	404TSTD6001	✓	\$8,269	E1	94.1	138	973	33.85		A414
	1800	460	405T	GT0049	405TTDC6060	✓	\$7,778	E1	95.4	140	1150	38.78		A415
	1200	460	445T	GT0050	445TTDC16076	✓	\$12,586	E1	95.0	145	1799	44.57		A417
150	3600	460	405TS	GT0051	405TSTD6007	✓	\$9,676	E1	94.1	163	1075	35.45		A414
	1800	460	444T	GT0052	444TTDC6060	✓	\$10,442	E1	95.8	168	1275	44.57		A417
	1200	460	447T	GT0053	447TTDC16077	✓	\$12,941	E1	95.4	172	2050	49.69		A419
200	3600	460	444TS	GT0054	444TSTD16003	✓	\$15,051	E1	95.0	215	1277	40.83		A416
	1800	460	445T	GT0055	445TTDC6060	✓	\$13,102	E1	95.8	220	1885	44.57		A417
	1200	460	449T	GT0056	449TTDC16076	✓	\$16,501	E1	95.4	228	2200	49.69		A419

Catalog numbers (Cat No.) highlighted in bold blue have efficiency levels that meet EISA requirements

Blue shaded areas are Cast Iron Frames

General Purpose, Three Phase Totally Enclosed

Applications:

General purpose use on pumps, fans, blowers, compressors, conveyors, and other industrial machinery installed in damp, dusty, or dirty environments. Additionally, cast iron frame motors may be suitable for the process industries.



Features:

- Frame constructions are heavy gauge steel or Aluminum, as noted
- Ball bearings (except as noted)
- 1.15 Service Factor (except as noted)
- 60/50 hertz at next lower horsepower, as noted
- Will accept C-Face Kits as noted, also see Accessories section
- UL Recognized and CSA Certified
- Two year warranty on EISA efficient motors (bold blue Catalog Numbers)



Rigid Base

Suitable for use on VFD per guidelines on page 17.

HP	RPM	VOLTS	FRAME	CAT. NO.	MODEL NO.	STOCK	CT SPEED RANGE*	LIST PRICE	MULT. SYMB.	NOM. EFF.	F.L. AMPS	WEIGHT	"C" DIM.	FOOT NOTES	C FACE KITS
1/4	1800	208-230/460	48	K151	5K32GN30	√	-----	\$221	F1	62.9	1.3-1.4/0.7	14	9.92	20	N/A
	1800	230/460	48	K194	5K33KN92	√	-----	\$322	F1	67.5	1.2/0.6	15	9.19	17	N/A
	1800	208-230/460	56	K439	5K49DN4131	√	-----	\$283	F1	67.4	1.1-1.2/0.6	16	9.57	N,17	A536
	1800	575	48	K418	5K32GN53	√	-----	\$299	F1	61.2	0.6	16	9.92	17	N/A
	1200	230/460	56	K321	5K35MN75	√	-----	\$217	F1	66.0	1.4/0.7	17	10.93	20,68	AG215
1/3	3600	208-230/460	48	K153	5K33FN30	√	-----	\$221	F1	61.0	1.5-1.8/0.9	16	10.20	17	N/A
	1800	208-230/460	56	K154	5K49FN4136	√	-----	\$239	F1	69.2	1.5-1.6/0.8	20	10.73	20,68	A536
	1800	208-230/460	56	K196	5K49FN4129	√	-----	\$361	F1	73.4	1.3-1.4/0.7	18	9.57	17,N	A536
	1800	575	56	G304	56T17F2043	√	-----	\$239	F1	65.5	0.6	25	10.22	25	N/A
	1200	230/460	56	K155	5K36PN30	√	-----	\$336	F1	67.3	1.8/0.9	20	11.40	20,68	AG215
1/2	3600	208-230/460	56	G308	56T34F5328	√	2:1	\$217	F1	66.0	2.1-2.2/1.1	22	11.82	68	A437
	3600	575	56	G309	56T34F5333	√	2:1	\$217	F1	66.0	0.9	22	11.82		A437
	1800	208-230/460	56	K158	5K35MNB117	√	-----	\$267	F1	76.1	2.1-2.2/1.1	17	10.93	19	AG215
	1800	208-230/460	56	K197	5K42HN4109	√	-----	\$402	F1	76.9	1.8-1.8/0.9	20	9.95	17,N	A536
	1800	575	56	K426	5K42HN4134	√	-----	\$267	F1	76.9	0.8	22	11.00	19,50	A536
	1200	208-230/460	56	K159	5K49MN6079	√	-----	\$369	F1	72.0	2.6-2.6/1.3	27	11.43	5,19	A536
3/4	3600	208-230/460	56	K160	5K37NN30	√	-----	\$259	F1	74.1	2.6-2.5/1.3	18	11.76	19	AG215
	3600	575	56	G327	56T34F5334	√	2:1	\$259	F1	74.0	1.3	23	11.82		A437
	1800	200-208	56	G328	56T17F2045	√	-----	\$295	F1	75.5	3.2/3.3	21	11.22	25	N/A
	1800	208-230/460	56	K161	5K36PNB111	√	-----	\$295	F1	78.9	2.8-2.8/1.4	20	11.36	19	AG215
	1800	208-230/460	56	K198	5K49PN4113	√	-----	\$414	F1	80.6	2.4-2.4/1.2	31	11.38	17,N	A536
	1800	575	56	G1340	5K36PN251	√	-----	\$295	F1	73.4	1.3	20	11.40	19	A536
	1200	208-230/460	56	K162	5K46PN6082	√	-----	\$382	F1	76.1	2.9-2.8/1.4	31	11.83	68	AG215
	1200	208-230/460	143T	H700	143TTFR5376	√	2:1	\$371	E6	74.0	3.2-3.2/1.6	28	12.37	68	A438
	1	3600	208-230/460	56	K163	5K38RN30	√	-----	\$291	F1	78.5	3.2-3.0/1.5	25	12.36	19,68
1	3600	575	56	G345	56T34F5335	√	2:1	\$291	F1	74.0	1.5	24	11.82		A437
	1800	200	143T	E824	143TTFR4028	√	10:1	\$347	E8	82.5	3.5	32	12.87		A438
	1800	208-230/460	56	G347	56T17F5302	√	2:1	\$309	F1	77.0	3.5-3.6/1.8	25	12.32	68	A437
	1800	208-230/460	56	K164	5K49MN4105	√	-----	\$394	F1	79.2	3.6-3.8/1.9	27	11.43	17	A536
	1800	575	56	K424	5K49MN4111	√	-----	\$309	F1	78.2	1.7	27	11.43	19	A536
	1200	230/460	56H	K165	5K49UN6085	√	-----	\$408	F1	76.1	3.6/1.8	37	13.07	18,68	A536

Catalog numbers (Cat No.) highlighted in bold blue have efficiency levels that meet EISA requirements

* Requires nameplate modification

Continued on next page.



General Purpose, Three Phase

Totally Enclosed

Rigid Base

HP	RPM	VOLTS	FRAME	CAT. NO.	MODEL NO.	STOCK	CT SPEED RANGE*	LIST PRICE	MULT. SYMB.	NOM. EFF.	F.L. AMPS	WEIGHT	"C" DIM.	FOOT NOTES	C FACE KITS
1 1/2	3600	200	143T	E830	143TTFR4003		2:1	\$366	E8	82.5	4.6	34	12.87		A438
	3600	208-230/460	56	K166	5K46KN2175	√	-----	\$351	F1	77.3	5.0-4.8/2.4	24	11.83	d	A536
	3600	575	56	G363	56T34F5336		2:1	\$351	F1	80.0	1.8	25	11.82		A437
	1800	200	145T	E836	145TTFR4029	√	10:1	\$387	E8	84.0	5.1	44	14.37		A438
	1800	200-208	145T	H665	145TTFR5328	√	2:1	\$339	E6	80.0	5.5-5.9	30	12.37	d	A438
	1800	208-230/460	56H	K167	5K49SN4118	√	-----	\$353	F1	81.7	4.7-4.4/2.2	35	13.07	5,19,68	A536
	1800	575	145T	E838	145TTFR4038	√	10:1	\$387	E8	84.0	1.8	44	14.37	d	A438
	2	3600	200	145T	E840	145TTFR4005		2:1	\$424	E8	84.0	6.0	38	13.37	
3600		575	56H	G368	56T34F5337		2:1	\$408	F1	80.0	2.4	29	12.32	5	A437
3600		575	145T	E843	145TTFR4007		2:1	\$424	E8	84.0	2.1	38	13.37		A438
1800		200	145T	E845	145TTFR4032	√	10:1	\$424	E8	84.0	64.5	46	13.87		A438
1800		200-208	145T	H666	145TTFR5330	√	2:1	\$373	E6	82.5	6.8-6.8	40	13.87	d	A438
1800		208-230/460	56	K1492	5K49ZN4252	√	-----	\$393	F1	83.6	6.2-5.8/2.9	44	14.38		A536
1800		575	145T	E847	145TTFR4039	√	10:1	\$424	E8	84.0	2.3	41	13.87	d	A438
1200		230/460	184T	E995	184TTFR4076	√	10:1	\$502	E8	86.5	6.0/3.0	72	15.97	d,68	A644
3	3600	208-230/460	56H	G385	56T34F5338		2:1	\$458	F1	84.0	8.4-7.6/3.8	39	13.52	5,68	A437
	3600	575	182T	U603	182TTFR4005		2:1	\$480	E8	85.5	3.0	67	14.97		A666
	1800	200	182T	U605A	182TTFW4327	√	10:1	\$454	E8	87.5	9.7	61	12.96	13	A644
	1800	230/460	56H	G387	56T17F5327		2:1	\$418	F1	84.0	8.6/4.3	48	14.82	68	A437
	1800	575	182T	U1608	182TTFW4040	√	10:1	\$454	E8	87.5	3.4	61	12.96	13	A666

Catalog numbers (Cat No.) highlighted in bold blue have efficiency levels that meet EISA requirements

* Requires nameplate modification

Continued on next page.

General Purpose, Three Phase

Totally Enclosed

Rigid Base

HP	RPM	VOLTS	FRAME	CAT. NO.	MODEL NO.	STOCK	CT SPEED RANGE*	LIST PRICE	MULT. SYMB.	NOM. EFF.	F.L. AMPS	WEIGHT	"C" DIM.	FOOT NOTES	C FACE KITS
5	3600	200	184T	U611	184TTFR4003		2:1	\$593	E8	87.5	14.3	86	15.97	13	A666
	3600	575	184T	U614	184TTFR4005		2:1	\$593	E8	87.5	5.0	78	15.97	13	A666
	1800	200	184T	U616	184TTFR4038	✓	10:1	\$530	E8	87.5	15.0	82	15.97	13	A666
	1800	200	184T	H1668	184TTFW7727	✓	2:1	\$484	E6	87.5	15.0	82	13.96	13	A666
	1800	575	184T	U1619	184TTFW4040	✓	10:1	\$530	E8	87.5	5.3	70	13.96	13	A666
7 1/2	3600	200	213T	U622	213TTFW4003		2:1	\$775	E8	89.5	21.2	136	20.23		A609
	3600	575	213T	U625	213TTFW4005		2:1	\$775	E8	88.5	7.4	128	18.73		A609
	1800	200	213T	U627	213TTFW4028	✓	10:1	\$760	E8	89.5	23.0	125	18.73		A609
	1800	200	213T	H669	213TTFW7028	✓	2:1	\$695	E8	87.5	22.3	103	18.73	d	A609
	1800	575	213T	U630	213TTFW4030	✓	10:1	\$760	E8	89.5	8.0	135	18.73	d	A609
10	3600	200	215T	U634	215TTFW4003		2:1	\$905	E8	89.5	27.6	152	20.23		A609
	3600	575	215T	E821	215TTFW4005		2:1	\$905	E8	89.5	9.6	145	20.23		A609
	1800	200	215T	E822	215TTFW4028	✓	10:1	\$920	E8	89.5	29.9	125	20.23		A609
	1800	208-230/460	215T	E1956	215TTFBA4026	✓	10:1	\$920	E8	89.5	27.6-25/12.5	163	20.24	d,68	A204
	1800	575	215T	U640	215TTFW4030	✓	10:1	\$920	E8	89.5	10.4	138	20.23	d	A609
15	3600	200	254T	U643	254TTFL14004		2:1	\$1,256	E8	90.2	40.5	178	22.49	AL	A1209
	3600	575	254T	U645	254TTFL14005		2:1	\$1,256	E8	90.2	14.0	178	22.99	AL	A1209
	1800	200	254T	U646	254TTFL14027	✓	10:1	\$1,248	E8	91.0	46.0	178	22.99	d,AL	A1209
	1800	200	254T	U646A	254TTFL14027	✓	10:1	\$1,248	E8	91.0	46.0	178	22.99	AL	A1209
20	1800	200	256T	U651	256TTFL14027	✓	10:1	\$1,536	E8	91.0	58.5	247	26.24	AL	A1209
	1800	575	256T	E998	256TTFL14030		10:1	\$1,536	E8	91.0	20.4	286	26.24	AL	A1209

Catalog numbers (Cat No.) highlighted in bold blue have efficiency levels that meet EISA requirements

* Requires nameplate modification



General Purpose, Three Phase Totally Enclosed



Applications:

General purpose use on pumps, fans, blowers, compressors, conveyors, and other industrial machinery installed in damp, dusty, or dirty environments. Additionally, cast iron frame motors may be suitable for the process industries.

Features:

- 1.15 Service Factor
- Nameplated 60/50 hertz at next lowest horsepower
- Will accept C-Face Kits as noted, also see Accessories section
- Severe duty kits available, see Accessories section
- Shaft slinger, regreasable bearings (182T and larger), lead lugs (364T and larger), and bearing caps on 444T and larger
- Ball bearings, except where noted
- UL Recognized and CSA Certified
- Two year warranty on EISA efficient motors (bold blue Catalog Numbers)



Rigid Base

Suitable for use on VFD per guidelines on page 17.

HP	RPM	VOLTS	FRAME	CAT. NO.	MODEL NO.	STOCK	CT SPEED RANGE*	LIST PRICE	MULT. SYMB.	NOM. EFF.	F.L. AMPS	WEIGHT	"C" DIM.	FOOT NOTES	C FACE KITS	
3/4	1200	208-230/460	143T	H457	143TTFN8076	✓	2:1	\$371	E6	74.0	3.1-3.2/1.6	46	12.04	68	A603	
	1	1800	200	143T	E825	143TTTN4028		1000:1	\$366	E1	82.5	3.7	50	10.43	N	A603
		1800	208-230/460	143T	E826	143TTTC4026	✓	1000:1	\$366	E1	85.5	3.2-3.0/1.5	51	10.43	N,68	A603
	1800	575	143T	E828	143TTTN4030	✓	1000:1	\$366	E1	82.5	1.3	50	10.43	d,N	A603	
	1200	230/460	145T	E829	145TTTN4076	✓	1000:1	\$467	E1	80.0	3.4/1.7	58	11.43	N,68	A655	
	1200	575	145T	U672	145TTTN4080	✓	1000:1	\$467	E1	80.0	1.3	57	11.43	N	A655	
	900	230/460	182T	L409A	182TTFN4101	✓	----	\$760	E8	74.0	4.4/2.2	92	15.87	68	A641	
1 1/2	3600	200	143T	E831	143TTTN4003		1000:1	\$386	E1	86.5	4.6	60	10.43	N	A603	
	3600	208-230/460	143T	E833	143TTTN4001	✓	1000:1	\$386	E1	82.5	4.4-4.0/2.0	51	10.43	N,68	A603	
	3600	575	143T	E835	143TTTN4005		1000:1	\$386	E1	86.5	1.6	42	10.43	N	A603	
	1800	200	145T	U601	145TTTN4032		1000:1	\$406	E1	84.0	5.1	62	11.43	N	A655	
	1800	208-230/460	145T	E837	145TTTC4026	✓	1000:1	\$406	E1	84.0	4.6-4.2/2.1	58	11.43	N,68	A655	
	1800	575	145T	E839	145TTTN4035	✓	1000:1	\$406	E1	84.0	1.8	62	11.43	N	A655	
	900	230/460	184T	L410A	184TTFS14101	✓	----	\$876	E8	78.5	6.1/3.05	99	15.81	68	A644	
900	230/460	184T	L410B	184TTFN4102	✓	----	\$876	E8	77.0	6.2/3.1	128	15.87	68	A641		
2	3600	200	145T	E841	145TTTN4003		1000:1	\$447	E1	86.5	6.0	70	11.43	N	A655	
	3600	208-230/460	145T	E842	145TTTN4001	✓	1000:1	\$447	E1	84.0	5.8-5.4/2.7	66	11.43	N,68	A655	
	3600	575	145T	E844	145TTTN4005		1000:1	\$447	E1	86.5	2.1	66	11.43	N	A655	
	1800	200	145T	U606	145TTTN4030		1000:1	\$447	E1	85.5	6.9	64	11.43	N	A655	
	1800	208-230/460	145T	E846	145TTTC4027	✓	1000:1	\$447	E1	84.0	6.0-5.6/2.8	60	11.43	N,68	A655	
	1800	575	145T	E848	145TTTN4040	✓	1000:1	\$47	E1	85.5	2.4	64	11.43	N	A655	
	900	230/460	213T	L411A	213TTFN4103	✓	----	\$1,231	E8	82.5	7.5/3.75	189	18.22	68	A646	
3	3600	208-230/460	182T	U602	182TTFS4001	✓	2:1	\$503	E1	85.5	8.6-7.4/3.7	91	14.81	d,68	A644	
	3600	575	182T	U604	182TTFS4005		2:1	\$503	E1	85.5	3.0	81	14.81		A644	
	1200	208-230/460	213T	U610	213TTFC4076	✓	10:1	\$699	E1	88.5	9.8-9.4/4.7	165	18.19	d,68	A652	
	900	230/460	215T	L421A	215TTFS14103	✓	----	\$1,603	E8	84.0	10.6/5.3	167	19.72	68	A206	
5	3600	575	184T	U615	184TTFS4005	✓	2:1	\$622	E1	87.5	4.9	106	15.81	d	A644	
	1800	575	184T	U620	184TTFS4030	✓	10:1	\$556	E1	87.5	5.2	102	15.81	d	A644	
	900	230/460	254T	L412A	254TTFNA14103	✓	----	\$2,213	E8	87.5	15.0/7.5	534	23.52	68	A284	
7 1/2	3600	575	213T	U671	213TTFS4005	✓	2:1	\$815	E1	88.5	7.6	191	18.20	d	A206	
	1800	575	213T	U631	213TTFS4030	✓	10:1	\$797	E1	89.5	8.0	174	18.20	d	A206	
	900	230/460	256T	L413A	256TTFNA14101	✓	----	\$2,816	E8	86.5	23.0/11.5	312	25.27	68	A284	

Catalog numbers (Cat No.) highlighted in bold blue have efficiency levels that meet EISA requirements

Blue shaded areas are Cast Iron Frames

* Requires nameplate modification

Continued on next page.

General Purpose, Three Phase

Totally Enclosed

Rigid Base

HP	RPM	VOLTS	FRAME	CAT. NO.	MODEL NO.	STOCK	CT SPEED RANGE*	LIST PRICE	MULT. SYMB.	NOM. EFF.	F.L. AMPS	WEIGHT	"C" DIM.	FOOT NOTES	C FACE KITS
10	3600	575	215T	U637	215TTFS4005		2:1	\$950	E1	90.2	9.6	184	19.70		A206
	1800	575	215T	U641	215TTFS4030	√	10:1	\$966	E1	89.5	10.0	222	19.70	d	A206
	1200	208-230/460	256T	U642	256TTFC4076	√	10:1	\$1,688	E1	89.5	28.3-26.2/13.1	298	24.92	d,68	A653
	900	230/460	284T	L414A	284TTFNA14102	√	---	\$3,337	E8	84.0	31.0/15.5	388	26.26	68	A618
15	3600	575	254T	U638	254TTFPA4005		2:1	\$1,319	E1	90.2	14.4	260	23.69		A239
	1800	575	254T	U648	254TTFNA4030	√	10:1	\$1,311	E1	91.0	15.6	308	23.52	d	A284
	1200	208-230/460	284T	E978	284TTFC4076	√	10:1	\$2,279	E1	90.2	44.7-40.4/20.2	358	26.26	d,68	A654
	900	230/460	286T	L415A	286TTFNA14106	√	---	\$4,385	E8	86.5	45.0/22.5	421	28.97	68	A618
20	3600	575	256T	U650	256TTFNA4005		2:1	\$1,732	E1	90.2	18.8	310	25.27		A284
	1800	575	256T	U653	256TTFNA4030	√	10:1	\$1,613	E1	91.0	20.0	331	25.27	d	A284
	900	230/460	324T	L416A	324TTFS14101	√	---	\$5,284	E8	87.5	64.0/32.0	512	28.97	68	A214
25	3600	230/460	284TS	E975	284TSTFPA4001	√	2:1	\$2,092	E1	91.0	60.0/30.0	343	24.89	d,68	A617
	3600	575	284TS	U654	284TSTFPA4005		2:1	\$2,092	E1	91.0	24.0	545	24.89		A617
	1800	575	284T	E800	284TTFPA4030	√	10:1	\$1,901	E1	92.4	24.8	324	26.27	d	A617
	1800	200	284T	U655	284TTFPA4028		10:1	\$1,901	E1	92.4	71.0	374	31.87		A617
	900	230/460	326T	L417	326TTFPA8107	√	---	\$5,817	E6	88.5	78.0/39.0	608	30.32	d,68	A619
	900	230/460	326T	L417A	326TTFS14101	√	---	\$6,258	E8	88.5	78.0/39.0	625	30.32	68	A214
30	3600	575	286TS	E819	286TSTFPA4005		2:1	\$2,306	E1	91.0	28.8	406	26.30		A617
	1800	575	286T	E817	286TTFPA4030	√	10:1	\$2,308	E1	92.4	29.6	406	27.76	d	A617
	900	460	364T	L420	364TTFS8101	√	---	\$6,526	E6	91.0	41.0	886	31.50	68,89	A395
40	1800	575	324T	E815	324TTFPA4030	√	2:1	\$2,985	E1	93.0	40.0	555	28.97	d	A619
	900	460	365T	L425	365TTFS8115	√	---	\$8,085	E6	91.0	53.5	970	32.50	68,89	A395
50	1800	575	326T	U659	326TTFPA4030	√	2:1	\$3,843	E1	93.0	49.0	589	30.47	d	A619
	900	460	404T	L426	404TTFS8102	√	---	\$9,632	E6	92.4	69.0	1191	35.62	68,89	A223
60	1800	575	364T	U660	364TTFS4040	√	2:1	\$5,639	E1	93.6	57.5	952	31.50	d	A395
	1200	230/460	404T	E803	404TTFS4086	√	2:1	\$6,957	E1	93.6	149/74.5	1219	35.62	d,68	A223
	900	460	405T	L427	405TTFS8114	√	---	\$11,169	E6	91.7	81.0	1340	37.12	68,89	A223

Catalog numbers (Cat No.) highlighted in bold blue have efficiency levels that meet EISA requirements

Blue shaded areas are Cast Iron Frames

* Requires nameplate modification

Continued on next page.



General Purpose, Three Phase

Totally Enclosed

Rigid Base

HP	RPM	VOLTS	FRAME	CAT. NO.	MODEL NO.	STOCK	CT SPEED RANGE*	LIST PRICE	MULT. SYMB.	NOM. EFF.	F.L. AMPS	WEIGHT	"C" DIM.	FOOT NOTES	C FACE KITS
75	1800	575	365T	E805	365TTFS4040	√	2:1	\$7,207	E1	94.1	71.0	1053	32.50	d	A395
	900	460	444T	L428	444TTFS8106	√	---	\$14,875	E6	93.0	97.0	1820	41.25	68,89	A229
100	900	460	445T	L429	445TTFN8115	√	---	\$18,794	E6	93.6	133	2377	43.19	68	A620
125	3600	460	444TS	E992	444TSTFS4001	√	2:1	\$13,436	E1	94.5	137	1719	37.50	d,PW	A232
	1800	460	444TS	E810	444TSTFS4026	√	2:1	\$11,214	E1	94.5	142	1787	37.50	d	A232
	900	460	445T	L440	445TTFN8102		---	\$21,852	E6	93.6	169	2377	43.19	H,RB,68	N/A
150	900	460	447/9	L442	449TTFS8111		---	\$24,652	E6	94.5	206	2872	51.69	H,RB,68	N/A
200	3600	460	445TS	E812	445TSTFN4005	√	2:1	\$20,109	E1	95.0	222	2262	39.44	d,H,68	A621
	900	460	L447/9T	L449	449TTFS8110	√	---	\$25,074	E6	94.5	270	3225	51.69	H,RB,YD,68	N/A
250	3600	460	447/9TS	L451A	449TSTFS14007	√	---	\$26,869	E9	95.4	275	2079	48.11	H,YD,68	A624
	1800	460	445T	L452	445TTFN8040	√	---	\$18,916	E9	95.0	285	2395	43.19	H,RB,YD,68	N/A
	1800	460	447/9T	L455	449TTFS8028		---	\$20,335	E9	95.0	290	2802	51.69	H,YD,68	A623
	1800	460	447/9T	L454	449TTFS8038	√	---	\$20,335	E9	95.0	290	2775	51.69	H,RB,YD,68	N/A
	1800	575	445T	L453	445TTFN8041		---	\$18,916	E9	95.0	228	2394	43.19	RB	N/A
	1200	460	447/9T	L456	449TTFS8087	√	---	\$21,131	E9	95.4	300	2895	51.69	H,RB,YD,68	N/A
	1200	460	447/9T	L457	449TTFS8077		---	\$21,131	E9	95.4	300	3092	51.69	H,YD,68	A623
300	900	460	L447/9T	L471	449TTFS18105		---	\$23,108	E6	94.5	330	3586	56.71	H,RB,YD,17	N/A
	3600	460	447/9TS	L459	449TSTFS8002	√	---	\$28,760	E9	95.4	330	2633	47.88	H,YD,68	A624
	1800	460	447/9T	L462	449TTFS8037	√	---	\$21,396	E9	95.4	338	2717	51.69	H,RB,YD,68	N/A
	1800	575	447/9T	L472A	---		---	\$22,872	E9	95.4	330	2900	51.86	H,RB,YD	A623
	1800	460	447/9T	L463	449TTFS8027	√	---	\$22,872	E9	95.4	338	3041	51.69	H,YD,68	A623
	1200	460	L447/9T	L465	449TTFS8076		---	\$24,543	E9	95.4	360	3440	51.69	H,YD,17,68	A623
	1200	460	447/9T	L464	449TTFS8086	√	---	\$24,543	E9	95.4	360	3428	51.69	H,RB,YD,17,68	N/A
350	3600	460	447/9TS	L466	449TSTFS8001	√	---	\$33,035	E9	95.4	380	2931	47.88	H,YD,68	A624
	1800	460	L447/9T	L467	449TTFS8036	√	---	\$24,420	E9	95.4	400	3042	51.69	H,RB,YD	N/A
400	1800	460	447/9T	L469A	449TTFS14043	√	---	\$27,882	E9	95.4	469	3088	51.86	H,RB,17	A623

Catalog numbers (Cat No.) highlighted in bold blue have efficiency levels that meet EISA requirements

Blue shaded areas are Cast Iron Frames

* Requires nameplate modification

General Purpose, Three Phase

Totally Enclosed

Applications:

General purpose use on gear reducers, pumps, machine tools, and other direct-coupled equipment installed in damp, dusty, or dirty environments. Additionally, cast iron frame motors may be suitable for the process industries.

Features:

- Ball bearings, mechanically locked on shaft end (excludes 5K models)
- Rated 60/50 hertz, 190/380 or 380 volt, at next lower horsepower (as noted)
- 1.15 Service Factor (except as noted)
- Rolled steel 56-145T frame motors accept brake kits, see Accessories section (except as noted)
- UL Recognized and CSA Certified



C-Face Footless

Suitable for use on VFD per guidelines on page 17.

HP	RPM	VOLTS	FRAME	CAT. NO.	MODEL NO.	STOCK	CT SPEED RANGE*	LIST PRICE	MULT. SYMB.	NOM. EFF.	F.L. AMPS	WEIGHT	"C" DIM.	FOOT NOTES
1/4	1800	208-230/460	56C	K252	5K49DN4130	✓	-----	\$237	F1	67.4	1.1-1.2/0.6	16	9.52	N,20,24,68
	1800	575	56C	K405	56T17F2047		-----	\$237	F1	62.0	0.5	13	9.94	24
1/3	3600	208-230/460	56C	P101	56T34T5306	✓	2:1	\$205	F1	64.0	1.7-2.0/1.0	18	9.94	N,68
	1800	208-230/460	56C	K253	5K33JNA943	✓	-----	\$253	F1	68.8	1.5-1.6/0.8	16	10.60	24,68,111
1/2	1800	575	56C	K522	5K33KN67	✓	-----	\$253	F1	71.1	0.6	16	10.60	20,24,68
	3600	208-230/460	56C	P102	56T34F5321	✓	2:1	\$228	F1	66.0	2.1-2.2/1.1	21	11.82	68
3/4	1800	208-230/460	56C	K254	5K35MNB114	✓	-----	\$295	F1	76.1	2.1-2.2/1.1	17	10.93	19,24
	1800	575	56C	K469	5K42HN4137	✓	-----	\$295	F1	76.9	0.8	22	11.01	19,24,68
1	1200	208-230/460	56C	K1316	5K49MN6020	✓	-----	\$464	F1	72.0	2.6-2.6/1.3	27	11.44	19,24
	3600	208-230/460	56C	P103	56T34F5322	✓	2:1	\$270	F1	72.0	3.0-3.2/1.6	22	11.82	68
1	1800	208-230/460	56C	K255	5K36PNB116	✓	-----	\$325	F1	78.9	2.8-2.8/1.4	20	11.36	19,24,68
	1800	575	56C	K523	5K36PN254	✓	-----	\$325	F1	73.4	1.3	20	11.36	19,24,68
1	1200	208-230/460	143TC	K1318	5K49PN8030	✓	-----	\$480	E6	76.1	2.9-2.8/1.4	31	12.56	24
	1200	208-230/460	56C	K1317	5K49PN6025	✓	-----	\$472	F1	76.1	2.9-2.9/1.4	31	12.44	24
1	1200	208-230/460	56C	K404	56T11F5320		2:1	\$392	F1	74.0	3.1-3.2/1.6	26	12.32	68
	3000	208-220/440	56C	K633	5K36MN4152	✓	-----	\$400	F1	77.0	3.6-3.6/1.8	20	11.36	17,24,68
1	3600	208-230/460	56C	P104	56T34F5323	✓	2:1	\$303	F1	74.0	3.7-3.7/1.85	24	11.82	68
	1800	208-230/460	56C	K256	5K49MN4104	✓	-----	\$332	F1	79.2	3.6-3.8/1.9	27	11.44	19,24,68
1	1800	208-230/460	143TC	C220A	143TTFR4329	✓	2:1	\$375	E8	82.5	3.2-3.0/1.5	35	12.87	68
	1800	575	56C	K524	5K49MN4112	✓	-----	\$332	F1	78.2	1.7	27	11.44	19,24
1	1800	575	143TC	C230	143TTFR5333		2:1	\$348	E6	77.0	1.5	26	12.37	
	1800	575	143TC	C230A	143TTFR4333		2:1	\$375	E8	82.5	1.2	32	12.37	
1	1200	208-230/460	145TC	C250A	145TTFR4378	✓	2:1	\$469	E8	80.0	3.6-3.4/1.7	39	13.37	68
	1200	208-230/460	56C	K1490	5K49PN6164	✓	-----	\$483	F1	74.2	3.9-3.8/1.9	31	12.44	24
1	1200	208-230/460	56C	K407	56T11F5321		2:1	\$419	F1	77.0	3.8-3.6/1.8	33	12.82	68
	3600	208-230/460	56C	P105	56T34F5324	✓	2:1	\$352	F1	80.0	4.6/2.3	25	11.82	68
1	3600	208-230/460	56C	KG235	5K49PN2348	✓	-----	\$434	F1	81.7	4.8-4.2/2.1	31	12.44	24,68,111
	3600	208-230/460	143TC	C201	143TTFR5302	✓	2:1	\$360	E6	80.0	4.7-4.6/2.3	35	11.87	d,68
1	3600	208-230/460	143TC	C201A	143TTFR4302	✓	2:1	\$388	E8	82.5	4.4-4.0/2.0	41	11.87	68
	1800	208-230/460	56C	K257	5K49SN4117	✓	-----	\$365	F1	81.7	4.7-4.4/2.2	35	12.44	19,24,68
1	1800	208-230/460	145TC	C221A	145TTFR4332	✓	2:1	\$436	E8	84.0	4.6-4.4/2.2	38	14.37	68
	1800	575	56C	G548	56T17F5320		2:1	\$365	F1	80.0	1.9	31	12.32	
1	1800	575	145TC	C231	145TTFR5340		2:1	\$405	E6	80.0	1.9	29	12.37	
	1800	575	145TC	C231A	145TTFR4340		2:1	\$436	E8	84.0	1.8	38	14.37	
1	1200	230/460	182TC	C251A	---		2:1	\$845	E8	75.5	5.0/2.5	89	17.93	F,68
	2	3600	208-230/460	56C	P106	56T34F5325	✓	2:1	\$408	F1	80.0	6.0-6.0/3.0	29	12.32
1	3600	208-230/460	56C	KG237	5K49SN2187	✓	-----	\$497	F1	83.0	5.8-5.4/2.7	35	12.97	24,68,110
	3600	208-230/460	145TC	C202A	145TTFR4306	✓	2:1	\$451	E8	84.0	5.6-5.2/2.6	38	13.37	68
1	1800	208-230/460	56C	K1491	5K49ZN4253	✓	-----	\$393	F1	83.6	6.2-5.8/2.9	45	14.25	24,68
	1800	208-230/460	145TC	K2033	5KE48WN8365	✓	-----	\$533	E6	84.0	6.5-6/2.8	43	13.84	24,68
1	1800	208-230/460	145TC	K2043	5KE49UN8428	✓	-----	\$483	E6	84.0	6.4-6.0/3.0	40	12.62	24,68
	1800	575	56C	G549	56T17F5329		2:1	\$393	F1	82.5	2.3	41	13.82	
1	1800	575	145TC	C232	145TTFR5341		2:1	\$433	E6	82.5	2.3	41	13.87	
	1800	575	145TC	C232A	145TTFR14048		2:1	\$466	E8	84.0	2.3	49	14.87	
1	1200	230/460	184TC	C252A	---		2:1	\$947	E8	80.0	6.7/3.35	89	15.69	F,24,68

Catalog numbers (Cat No.) highlighted in bold blue have efficiency levels that meet EISA requirements

* Requires nameplate modification

Continued on next page.



General Purpose, Three Phase

Totally Enclosed

C-Face Footless

HP	RPM	VOLTS	FRAME	CAT. NO.	MODEL NO.	STOCK	CT SPEED RANGE*	LIST PRICE	MULT. SYMB.	NOM. EFF.	F.L. AMPS	WEIGHT	"C" DIM.	FOOT NOTES
3	3600	208-230/460	56C	P107	56T34F5326	✓	2:1	\$443	F1	84.0	8.4-7.6/3.8	38	13.32	68
	3600	208-230/460	145TC	C236A	145TTFR4307	✓	2:1	\$451	E8	85.8	8.4-7.6/3.8	39	13.37	68
	3600	208-230/460	182TC	C203	182TTFR7325	✓	2:1	\$535	E6	82.5	8.6-7.8/3.9	72	15.69	d,F,24,68
	3600	208-230/460	182TC	C203B	182TTFW14004	✓	2:1	\$575	E8	85.5	8.2-7.4/3.7	65	13.97	F,13,24,68
	1800	208-230/460	182TC	C223B	182TTFW4027	✓	2:1	\$552	E8	87.5	8.8-8.4/4.2	64	12.97	13,68
	1800	230/460	56C	K640	5K49QN4609	✓	-----	\$484	F1	84.7	8.2/4.1	54	14.89	17,24,68
5	1200	230/460	213TC	C253A	213TTFW14081		2:1	\$787	E8	81.5	9.6/4.8	108	19.46	F,24,68
	3600	208-230/460	184TC	C204B	184TTFW14004	✓	2:1	\$660	E8	87.5	13.4-12.2/6.1	74	14.47	13,68
	1800	208-230/460	184TC	C1224	184TTFW8641	✓	2:1	\$576	E8	87.5	16-14.8/7.4	70	13.97	13,68
7 1/2	1200	208-230/460	215TC	C254A	215TTFW14084		2:1	\$1,096	E8	87.5	16.0-14.8/7.4	179	20.96	24,68
	3600	208-230/460	184TC	C238B	184TTFW14021	✓	2:1	\$791	E8	88.5	18.5-16.8/8.4	95	15.97	13,68
	3600	208-230/460	213TC	C205A	213TTFW14011	✓	2:1	\$873	E8	88.5	21.0-19.2/9.6	84	19.46	F,24,68
	1800	208-230/460	213TC	C225A	213TTFW14045	✓	2:1	\$766	E8	89.5	22.0-19.4/9.7	110	19.46	F,24,68
10	1200	230/460	254TC	C255A	254TTFL14078		-----	\$1,481	E8	89.5	22.0/11.0	148	23.24	AL,F,24,68
	3600	208-230/460	215TC	C206A	215TTFW14024	✓	2:1	\$1,044	E8	89.5	27.0-24.0/12.0	142	20.96	F,24,68
	1800	208-230/460	215TC	C226A	215TTFW14041	✓	2:1	\$1,006	E8	89.5	28.0-26.0/13.0	138	20.96	F,24,68
15	1200	230/460	256TC	C256A	256TTFNA14086		-----	\$1,831	E8	89.5	26.0/13.0	375	25.94	F,24,68
	3600	208-230/460	215TC	C237A	215TTFW14022	✓	2:1	\$1,327	E8	90.2	39.0-36.0/18.0	154	20.96	F,24,68
	3600	230/460	254TC	C207A	254TTFL14009		-----	\$1,443	E8	90.2	35.0/17.5	210	23.24	AL,F,24,68
	1800	208-230/460	254TC	C227A	254TTFL14037	✓	-----	\$1,429	E8	91.0	42.0-40.0/20.0	199	23.24	AL,F,24,68

Catalog numbers (Cat No.) highlighted in bold blue have efficiency levels that meet EISA requirements

Blue shaded areas are Cast Iron Frames

* Requires nameplate modification

General Purpose, Three Phase Totally Enclosed

Features:

- Ball bearings, mechanically locked on shaft end (excludes 5K models)
- 1.15 Service Factor (except as noted)
- Class F insulation (except as noted)
- Rated 60/50 hertz, 190/380 or 380 volt, at next lower horsepower (as noted)
- 56-145T frame motors, accept brake kits, see accessory kits
- UL Recognized and CSA Certified
- Two year warranty on EPAct and NEMA Premium efficient (bold blue catalog numbers)



Additional features for "Four-In-One" motors only:

- CR200 Corona resistant magnet wire
- Bolt-on, removable rigid base
- Suitable for horizontal and vertical mounting
- Will accept drip cover kits, see Accessories section



C-Face Footed (Rigid and Removable Base)

Suitable for use on VFD per guidelines on page 17.

HP	RPM	VOLTS	FRAME	"FOUR IN-ONE"	CAT. NO.	MODEL NO.	STOCK	CT SPEED RANGE*	LIST PRICE	MULT. SYMB.	NOM. EFF.	F.L. AMPS	WEIGHT	"C" DIM.	FOOT NOTES
1/4	1800	208-230/460	56C		G565	56T17F2051		2:1	\$242	F1	62.5	1.2-1.4/0.7	14	9.94	BI,24,68
	1200	208-230/460	56C	YES	G586	56T11F5311	✓	2:1	\$343	F2	52.5	1.7-2.0/1.0	19	11.31	6,13,68
1/3	3600	208-230/460	56C	YES	D390	56T34T5303	✓	1000:1	\$217	F2	66.0	1.7-1.8/0.9	20	10.43	N,6,13,24,68
	3600	575	56C	YES	K702	56T34T5309		1000:1	\$217	F2	64.0	0.8	19	9.93	N,6,13,24
	1800	208-230/460	56C		K1322	5K42FN4035	✓	-----	\$270	F1	69.2	1.5-1.6/0.8	20	11.01	20,24,68
	1800	208-230/460	56C	YES	G580	56T17T5305	✓	1000:1	\$278	F2	68.0	1.4-1.6/0.8	20	9.93	N,6,13,24,68
	1800	575	56C	YES	K703	56T17T5316	✓	1000:1	\$278	F2	68.0	0.7	20	9.93	N,6,13,24
	1200	208-230/460	56C	YES	G587	56T11F5310	✓	10:1	\$361	F2	62.0	1.9-2.2/1.1	21	11.31	6,13,68
1/2	3600	208-230/460	56C		G569	56T34F5308		2:1	\$233	F1	66.0	2.1-2.2/1.1	23	11.82	BI,13,68
	3600	208-230/460	56C	YES	D391	56T34F5301	✓	10:1	\$242	F2	66.0	2.1-2.2/1.1	22	11.81	6,13,68
	3600	575	56C	YES	K704	56T34F5348	✓	10:1	\$242	F2	66.0	0.9	22	11.81	6,13
	1800	208-230/460	56C		K1324	5K42HN4034	✓	-----	\$299	F1	74.7	2.3-2.2/1.1	22	11.01	19,24,68
	1800	208-230/460	56C	YES	G581	56T17F5321	✓	10:1	\$308	F2	68.0	2.3-2.4/1.2	24	11.81	6,13,68
	1800	575	56C	YES	K705	56T17F5336	✓	10:1	\$308	F2	68.0	1.0	23	11.81	6,13
	1200	208-230/460	56C	YES	G588	56T11F5309	✓	10:1	\$393	F2	68.0	2.4-2.7/1.35	23	11.81	6,13,68
	3/4	3600	208-230/460	56C	YES	D392	56T34F5302	✓	4:1	\$282	F2	68.0	3.0-3.2/1.6	23	11.81
3600		575	56C	YES	K706	56T34F5349	✓	4:1	\$282	F2	68.0	1.3	23	11.81	6,13
1800		208-230/460	56C		K258	5K49KN4124	✓	----	\$330	F1	74.3	3.3-3.0/1.5	24	11.41	19,24,68
1800		208-230/460	56C	YES	G582	56T17F5322	✓	10:1	\$337	F2	75.5	2.6-3.0/1.5	40	11.81	6,13,68
1800		575	56C	YES	K707	56T17F5337	✓	10:1	\$337	F2	75.5	1.2	24	11.81	6,13
1200		208-230/460	56C	YES	G589	56T11F5308	✓	4:1	\$405	F2	74.0	3.1-3.2/1.6	27	12.31	6,13,68
1	3600	208-230/460	56C		K500	5K38RN106	✓	-----	\$307	F1	78.5	3.2-3.0/1.5	32	12.4	19,24,68
	3600	208-230/460	56C	YES	D393	56T34F5303	✓	4:1	\$314	F2	74.0	3.7-3.7/1.85	25	11.81	6,13,68
	3600	575	56C	YES	K708	56T34F5350	✓	4:1	\$314	F2	77.0	1.5	25	11.81	6,13
	1800	208-230/460	56C		K259	5K49MN4110	✓	-----	\$336	F1	79.2	3.6-3.8/1.9	27	11.41	19,24,68
	1800	208-230/460	143TC		K2039	5KE49UN8429	✓	-----	\$441	E8	77.0	3.4-3.2/1.6	40	12.12	d,24
	1800	208-230/460	56HC	YES	G583	56T17F5323	✓	10:1	\$344	F2	77.0	3.5-3.6/1.8	26	12.31	5,6,13,68
	1800	575	56HC	YES	K709	56T17F5338	✓	4:1	\$344	F2	77.0	1.5	27	12.31	5,6,13
	1200	208-230/460	56HC	YES	K701	56T11F5307	✓	4:1	\$433	F2	77.0	3.95-4.0/2.0	32	12.81	5,6,13,68

Catalog numbers (Cat No.) highlighted in bold blue have efficiency levels that meet EISA requirements

* Requires nameplate modification

Continued on next page.

General Purpose, Three Phase

Totally Enclosed

C-Face Footed (Rigid and Removable Base)

HP	RPM	VOLTS	FRAME	"FOUR IN-ONE"	CAT. NO.	MODEL NO.	STOCK	CT SPEED RANGE*	LIST PRICE	MULT. SYMB.	NOM. EFF.	F.L. AMPS	WEIGHT	"C" DIM.	FOOT NOTES
1 1/2	3600	230/460	143TC		U733	143TTFR4010	✓	2:1	\$436	E8	82.5	4.0/2.0	35	12.87	d,68
	3600	208-230/460	56C	YES	D394	56T34F5304	✓	2:1	\$375	F2	80.0	4.7-4.6/2.3	25	11.81	6,13,68
	3600	575	56C	YES	K721	56T34F5351	✓	2:1	\$375	F2	80.0	1.8	26	11.81	6,13
	1800	200	145TC		U703	145TTFR4046		10:1	\$415	E8	84.0	5.1	44	14.37	
	1800	208-230/460	56HC		K260	5K49SN4119	✓	---	\$369	F1	81.7	4.7-4.4/2.2	35	12.44	19,24,50
	1800	575	145TC		U705	145TTFR4052		10:1	\$415	E8	84.0	1.8	44	14.37	6
	1800	208-230/460	56HC	YES	G584	56T17F5324	✓	10:1	\$376	F2	80.0	4.8-4.8/2.4	30	12.31	5,6,13,68
	1800	575	56HC	YES	K722	56T17F5339	✓	2:1	\$376	F2	80.0	1.9	29	12.31	5,6,13
	1200	230/460	56HC	YES	K700	56T11F5328	✓	2:1	\$460	F2	77.5	5.8/2.9	42	14.32	5,6,13,17
	2	3600	208-230/460	56HC	YES	D395	56T34F5305	✓	2:1	\$433	F2	80.0	6.0-6.0/3.0	29	12.31
3600		575	56HC	YES	K723	56T34F5352	✓	2:1	\$433	F2	80.0	2.4	30	12.31	5,6,13
1800		200	145TC		U706	145TTFR4070		10:1	\$445	E8	84.0	6.4	42	13.87	
1800		208-230/460	56HC		K806	56T17F5330		2:1	\$410	F1	82.5	6.0-5.8/2.9	40	13.82	BI,5,68
1800		575	145TC		U708	145TTFR4126		10:1	\$445	E8	84.0	2.2	42	13.87	
1800		208-230/460	56HC	YES	G585	56T17F5325	✓	10:1	\$409	F2	82.5	6.0-5.8/2.9	40	13.81	5,6,13,68
1800		575	56HC	YES	K724	56T17F5340	✓	4:1	\$409	F2	82.5	2.3	39	13.81	5,6,13
1200		230/460	184TC	YES	C1380	184TTFW4380	✓	10:1	\$741	E8	86.5	6.0/3.0	69	16.50	d,6,13,24,68
1200		230/460	184TC	YES	C380B	184TTFW16051	✓	10:1	\$866	E8	88.5	6.4/3.2	74	14.97	6,13,24,68
3		3600	200	182TC		U736	182TTFR4013		2:1	\$622	E8	85.5	8.5	76	15.69
	3600	208-230/460	56HC	YES	D396	56T34F5306	✓	2:1	\$481	F2	84.0	8.4-7.6/3.8	40	13.31	5,6,13,68
	3600	575	56HC	YES	K725	56T34F5353	✓	2:1	\$481	F2	84.0	3.1	40	13.31	5,6,13
	3600	208-230/460	182TC	YES	C381	182TTFR4320	✓	10:1	\$756	E8	85.5	8.2-7.4/3.7	76	15.50	d,6,24,68
	3600	208-230/460	182TC	YES	C381B	182TTFW16021	✓	10:1	\$884	E8	86.5	8.2-7.4/3.7	75	14.47	6,13,24,68
	1800	230/460	56HCZ	YES	G590	56T17F5355	✓	---	\$460	F2	85.5	8.6/4.3	48	14.87	Z,5,6,13,17,68
	1800	575	56HCZ	YES	G591	56T17F5356		---	\$460	F2	85.5	3.4	48	14.87	Z,5,6,13,17
	1800	208-230/460	182TC	YES	C382B	182TTFW16030	✓	10:1	\$790	E8	89.5	8.6-7.8/3.9	75	14.47	6,13,24,68
	1800	575	182TC	YES	C383A	182TTFW4345	✓	10:1	\$676	E8	87.5	3.4	76	15.50	d,6,13,24
	1800	575	182TC	YES	C383B	182TTFW16027	✓	10:1	\$790	E8	89.5	3.2	89	14.97	6,13,24
5	1200	208-230/460	213TC	YES	C384A	213TTFW16078	✓	10:1	\$1,105	E8	89.5	9.2-8.8/4.4	123	20.97	6,24,68
	3600	200	184TC		U738	184TTFR4013		2:1	\$731	E8	87.5	14.2	90	16.69	24,13
	3600	208-230/460	184TC	YES	C385B	184TTFW16006	✓	10:1	\$944	E8	88.5	13.1-12.0/6.0	94	14.97	13,24,68
	1800	230/460	184TC	YES	C386A	184TTFW4340	✓	10:1	\$712	E8	87.5	14.8/7.4	71	13.97	d,13,24,68
	1800	230/460	184TC	YES	C386B	184TTFW16027	✓	10:1	\$833	E8	89.5	12.6/6.3	85	14.97	13,24,68
	1800	575	184TC	YES	C387	184TTFR4345	✓	10:1	\$712	E8	87.5	5.2	86	16.50	d,6,24
	1800	575	184TC	YES	C387A	184TTFW4345	✓	10:1	\$712	E8	87.5	5.2	72	16.50	d,6,13,24,68
	1800	575	184TC	YES	C387B	184TTFW16029	✓	10:1	\$833	E8	89.5	5.1	72	14.97	6,13,24,68
	1200	208-230/460	215TC	YES	C388A	215TTFW16079	✓	10:1	\$1,127	E8	90.2	15.0-14.0/7.0	157	22.22	6,13,24,68

Catalog numbers (Cat No.) highlighted in bold blue have efficiency levels that meet EISA requirements

* Requires nameplate modification

Continued on next page.

General Purpose, Three Phase

Totally Enclosed

C-Face Footed (Rigid and Removable Base)

HP	RPM	VOLTS	FRAME	"FOUR IN-ONE"	CAT. NO.	MODEL NO.	STOCK	CT SPEED RANGE*	LIST PRICE	MULT. SYMB.	NOM. EFF.	F.L. AMPS	WEIGHT	"C" DIM.	FOOT NOTES
7 1/2	3600	200	213TC		U740	213TTFW4007		2:1	\$958	E8	89.5	21.2	118	20.97	24
	3600	575	213TC		U742	213TTFW4008		2:1	\$958	E8	89.5	7.4	118	20.97	24
	3600	208-230/460	213TC	YES	C389A	213TTFW16008	✓	10:1	\$1,225	E8	90.2	19.6-17.8/8.9	125	20.97	6,24,68
	1800	208-230/460	213TC	YES	C390A	213TTFW16035	✓	10:1	\$1,105	E8	91.7	21.0-18.6/9.3	157	22.22	6,24,68
	1800	575	213TC	YES	C391	213TTFW4345	✓	10:1	\$945	E8	89.5	8.0	122	20.97	d,6,24
	1800	575	213TC	YES	C391A	213TTFW16036	✓	10:1	\$1,105	E9	91.7	7.5	157	22.22	6,24
10	3600	200	215TC		U743	215TTFW4013		2:1	\$1,012	E8	89.5	27.6	175	20.97	24
	3600	208-230/460	215TC	YES	C392A	215TTFW16005	✓	10:1	\$1,275	E8	91.7	26.4-23.6/11.8	139	22.22	6,24,68
	1800	200	215TC		U718	215TTFW4033		10:1	\$957	E8	89.5	29.9	128	20.97	24
	1800	208-230/460	215TC	YES	C393A	215TTFW16041	✓	10:1	\$1,215	E8	91.7	28.0-26.0/13.0	189	22.22	6,24,68
	1800	575	215TC	YES	C394	215TTFW4345		10:1	\$1,039	E8	89.5	10.4	191	20.97	6,24
	1800	575	215TC	YES	C394A	215TTFW16042		10:1	\$1,215	E8	91.7	10.3	208	22.22	6,24
15	1800	200	254TC		U721	254TTFW4033		10:1	\$1,436	E8	91.0	46.0	189	23.24	AL,24
	1800	575	254TC		U723	254TTFW4035		10:1	\$1,436	E8	91.0	16.0	236	23.24	AL,24
20	3600	230/460	256TC		U815	256TTFNA14004	✓	2:1	\$1,933	E8	90.2	47.0/23.5	325	25.76	d,24,68
30	3600	230/460	286TSC		U750	286TSTFPA14002	✓	2:1	\$2,610	E8	91.0	72.0/36.0	392	26.26	d,24,68
40	3600	230/460	324TSC		U830	324TSTFPA14003	✓	2:1	\$3,455	E8	91.7	95.0/47.5	487	27.47	d,24,68

Catalog numbers (Cat No.) highlighted in bold blue have efficiency levels that meet EISA requirements

Blue shaded areas are Cast Iron Frames

* Requires nameplate modification

Brake Kits for

56-143-145 frames ONLY (as noted)

TORQUE (LB-FT)	COIL VOLTAGE	CAT. NO.	STOCK	LIST (LOOSE)	LIST (INSTALLED)	MULT. SYMB.	WEIGHT
3	208-230/460	A301	✓	\$398	\$563	S4	10
	208-230/460	A1301	✓	\$398	\$563	S4	10
	575	A297	✓	\$398	\$563	S4	10
	575	A1297	✓	\$398	\$563	S4	3
6	208-230/460	A302	✓	\$469	\$632	S4	11
	208-230/460	A1302	✓	\$469	\$632	S4	10
	575	A298	✓	\$469	\$632	S4	11
10	208-230/460	A303	✓	\$580	\$737	S4	10
	208-230/460	A1303	✓	\$580	\$737	S4	10
	575	A299	✓	\$580	\$737	S4	10
	575	A1299	✓	\$580	\$737	S4	10

Drip Cover Kits (Four-In-One)

CAT. NO.	STOCK	FRAME	LIST PRICE	MULT. SYMB.	WEIGHT
A234	✓	56-143T-145T	\$24	S4	2
A197	✓	182T-184T	\$27	S4	3
A199	✓	213T-215T	\$31	S4	5

GENERAL PURPOSE THREE PHASE



NEMA Premium® XRI® Efficiency

Three Phase, Totally Enclosed

Applications:

General purpose use on compressors, pumps, conveyors, blowers, and other machinery in dirty and dusty environments. Substantial energy savings can be realized when using these high efficiency motors. Guaranteed efficiencies offer an **eXtra R**eturn on your **I**nvestment when using these premium efficiency motors on high cycle or long run time applications.

Features:

☛ **Meets or exceeds NEMA Premium® efficiencies, except where noted NEMA Premium® models are in compliance with EISA2007**

- Suitable for use on a VFD. Variable Torque and Constant Torque (as noted)
- 1.15 Service Factor on sinewave, 1.0 Service Factor on IGBT power
- F1 conduit box on Rigid Base, F3 on C-Face Footed (Rigid Base) motors
- Shaft slinger
- Class F insulation
- 1.15 Service Factor
- Ball bearings (except as noted)
- C-Face Footed models are rated 60/50 Hz, same HP
- Motors accept C-face kits, as noted
- UL Recognized, CSA Certified and CE Mark
- Three year warranty



Rigid Base



Models through 40 HP are capable of modification as follows (contact factory to confirm):

- 1.25 Service Factor (sinewave only)
- 50Hz at same HP, 1.0 Service Factor (sinewave only)
- Certain combinations of existing and new nameplate markings are not possible (contact factory to confirm)
- Any nameplate changes are subject to modification charges (see MOD Central section)
- Contact Marathon Electric for optional nameplate markings on 50 HP and larger

Rigid Base

Suitable for use on VFD per guidelines on page 17.

HP	RPM	VOLTS	FRAME	CAT. NO.	MODEL NO.	STOCK	CT SPEED RANGE*	LIST PRICE	MULT. SYMB.	NOM. EFF.	F.L. AMPS	WEIGHT	"C" DIM.	FOOT NOTES	C FACE KITS
1	3600	200	56H	E2150	56T34F16001		10:1	\$540	E9	80.0	3.2	24	11.31		A665
	3600	230/460	56H	E2100	56T34F15940	✓	10:1	\$540	E9	80.0	2.8/1.4	24	11.31		A665
	3600	575	56H	E2125	56T34F16020		10:1	\$540	E9	80.0	1.1	24	11.31		A665
	1800	200	143T	E2151	143TTFR16038	✓	10:1	\$465	E9	85.5	3.7	32	13.75		A642
	1800	230/460	143T	E2101	143TTFR15642	✓	10:1	\$465	E9	85.5	3.2/1.6	32	13.75		A642
	1800	575	143T	E2126	143TTFR16040	✓	10:1	\$465	E9	85.5	1.3	32	13.75		A642
	1200	200	145T	E2152	145TTFR15581		10:1	\$555	E9	82.5	4.4	42	13.43		A642
	1200	230/460	145T	E2102	145TTFR16078	✓	10:1	\$555	E9	82.5	3.8/1.9	42	13.75		A642
	1200	575	145T	E2127	145TTFR16080		10:1	\$555	E9	82.5	1.5	42	13.75		A642
1 1/2	3600	200	143T	E2153	143TTFR16001		10:1	\$561	E9	84.0	4.6	37	13.75		A642
	3600	230/460	143T	E2103	143TTFR15582	✓	10:1	\$561	E9	84.0	4.0/2.0	37	13.75		A642
	3600	575	143T	E2128	143TTFR16020		10:1	\$561	E9	84.0	1.6	37	13.75		A642
	3600	230/460	143T	E351	143TTN6001		20:1	\$655	E9	86.5	4.0/2.0	54	10.43	N,NE	A603
	1800	200	145T	E2154	145TTFR16038	✓	10:1	\$478	E9	86.5	5.5	34	13.75		A642
	1800	230/460	145T	E2104	145TTFR16033	✓	10:1	\$478	E9	86.5	4.8/2.4	34	13.75		A642
	1800	575	145T	E2129	145TTFR16040	✓	10:1	\$478	E9	86.5	1.9	34	13.75		A642
	1200	200	182T	E2155	182TTFW16082		10:1	\$710	E9	87.5	6.0	89	14.47	13	A666
	1200	230/460	182T	E2105	182TTFW16076	✓	10:1	\$710	E9	87.5	5.6/2.8	89	14.97	13	A666
	1200	208-230/460	182T	E823A	182TTFW6077	✓	10:1	\$758	E9	87.5	6.2-5.6/2.8	98	15.96		N/A
	1200	575	182T	E2130	182TTFW16080		10:1	\$710	E9	87.5	2.2	89	14.47	13	A666
	1200	575	182T	E001	182TTFW6081	✓	10:1	\$758	E9	87.5	2.2	98	15.96		N/A

Catalog numbers (Cat No.) highlighted in bold blue have efficiency levels that meet EISA requirements

Blue shaded areas are Cast Iron Frames

* Requires nameplate modification

NEMA Premium® XRI® Efficiency

Three Phase, Totally Enclosed

Rigid Base

HP	RPM	VOLTS	FRAME	CAT. NO.	MODEL NO.	STOCK	CT SPEED RANGE*	LIST PRICE	MULT. SYMB.	NOM. EFF.	F.L. AMPS	WEIGHT	"C" DIM.	FOOT NOTES	C FACE KITS
2	3600	200	145T	E2156	145TTFR16001		10:1	\$578	E9	85.5	5.5	44	13.75		A642
	3600	230/460	145T	E2106	145TTFR13002	✓	10:1	\$578	E9	85.5	4.8/2.4	44	13.75		A642
	3600	575	145T	E2131	145TTFR16020		10:1	\$578	E9	85.5	1.9	44	13.75		A642
	3600	230/460	145T	E353	145TTTN6001		20:1	\$642	E9	85.5	5.0/2.5	64	11.43	N,NE,20	A603
	1800	200	145T	E2157	145TTFR16038	✓	10:1	\$525	E9	86.5	6.7	50	14.75		A642
	1800	230/460	145T	E2107	145TTFR16035	✓	10:1	\$525	E9	86.5	5.8/2.9	50	14.75		A642
	1800	575	145T	E2132	145TTFR16045	✓	10:1	\$525	E9	86.5	2.3	50	14.75		A642
	1200	200	184T	E2158	184TTFW16079		10:1	\$839	E9	88.7	7.4	89	14.97	13	A666
	1200	230/460	184T	E2108	184TTFW16076	✓	10:1	\$839	E9	88.7	6.4/3.2	89	14.97	13	A666
	1200	208-230/460	184T	E849A	184TTFC6077	✓	10:1	\$899	E9	88.5	7.9-7.2/3.6	125	16.80		N/A
	1200	575	184T	E2133	184TTFW16081		10:1	\$839	E9	88.7	2.6	89	14.97	13	A666
	1200	575	184T	E002	184TTFC6081	✓	10:1	\$899	E9	88.5	3.0	125	16.80		N/A
3	3600	200	182T	E2159	182TTFW16002	✓	10:1	\$777	E9	86.5	8.7	66	13.97	13	A666
	3600	230/460	182T	E2109	182TTFW16001	✓	10:1	\$777	E9	86.5	7.6/3.8	66	13.97	13	A666
	3600	208-230/460	182T	U602A	182TTFC6002	✓	10:1	\$836	E9	86.5	8.4-7.6/3.8	66	13.96		N/A
	3600	575	182T	E2134	182TTFW16020	✓	10:1	\$777	E9	86.5	3.0	66	13.97	13	A666
	3600	575	182T	U604A	182TTFC6006	✓	10:1	\$836	E9	86.5	3.0	66	13.96		N/A
	3600	230/460	182T	E216	182TTTS6001		20:1	\$882	E9	89.5	7.6/3.8	94	12.71	N,NE,20	A644
	1800	200	182T	E2160	182TTFW16038	✓	10:1	\$693	E9	89.5	9.0	80	13.97	13	A666
	1800	230/460	182T	E2110	182TTFW16026	✓	10:1	\$693	E9	89.5	7.8/3.9	80	13.97	13	A666
	1800	208-230/460	182T	U607A	182TTFC6027	✓	10:1	\$747	E9	89.5	8.9-7.8/3.9	104	15.89		N/A
	1800	575	182T	E2135	182TTFW16040	✓	10:1	\$693	E9	89.5	3.1	80	13.97	13	A666
	1800	575	182T	U609A	182TTFC6031	✓	10:1	\$747	E9	89.5	3.2	104	15.89		N/A
	1800	575	182T	E303	182TTTS6030	✓	1000:1	\$791	E9	90.2	3.2	100	12.71	d,N,NE	A644
	1200	200	213T	E2161	213TTFW16082		10:1	\$1,026	E9	89.5	10.1	115	18.73		A609
	1200	230/460	213T	E2111	213TTFW16076	✓	10:1	\$1,026	E9	89.5	8.8/4.4	115	18.73		A609
	1200	208-230/460	213T	U610A	213TTFC6077	✓	10:1	\$1,093	E9	89.5	10.3-9.4/4.7	171	18.19		N/A
	1200	575	213T	E2136	213TTFW16081		10:1	\$1,026	E9	89.5	3.5	115	18.73		A609
	1200	575	213T	E003	213TTFC6081	✓	10:1	\$1,093	E9	89.5	3.7	171	18.19		N/A
5	3600	200	184T	E2162	184TTFW16002	✓	10:1	\$882	E9	88.5	13.8	96	16.47	13	A666
	3600	230/460	184T	E2112	184TTFW16001	✓	10:1	\$882	E9	88.5	12.0/6.0	96	16.47	13	A666
	3600	208-230/460	184T	U613A	184TTFC6002	✓	10:1	\$959	E9	88.5	13.2-12.0/6.0	112	16.52		N/A
	3600	575	184T	E2137	184TTFW16020	✓	10:1	\$882	E9	88.5	4.8	96	16.47	13	A666
	3600	575	184T	U615A	184TTFC6006	✓	10:1	\$959	E9	88.5	5.2	112	16.52		N/A
	1800	200	184T	E2163	184TTFW16038	✓	10:1	\$810	E9	89.5	14.7	94	14.97	13	A666
	1800	230/460	184T	E2113	184TTFW16026	✓	10:1	\$810	E9	89.5	12.8/6.4	94	14.97	13	A666
	1800	208-230/460	184T	U618A	184TTFC6027	✓	10:1	\$873	E9	89.5	14.0-12.8/6.4	109	16.80		N/A
	1800	575	184T	E2138	184TTFW16040	✓	10:1	\$810	E9	89.5	5.1	94	14.97	13	A666
	1800	575	184T	U620A	184TTFC6031	✓	10:1	\$873	E9	89.5	5.3	109	16.80		N/A
	1200	200	215T	E2164	215TTFW16081		10:1	\$1,326	E9	90.2	16.1	135	20.23		A609
	1200	230/460	215T	E2114	215TTFW16076	✓	10:1	\$1,326	E9	90.2	14.0/7.0	135	20.23		A609
	1200	208-230/460	215T	U621A	215TTFC6077	✓	10:1	\$1,377	E9	90.2	15.8-14.4/7.2	176	19.61		N/A
	1200	575	215T	E2139	215TTFW16080		10:1	\$1,326	E9	90.2	5.6	135	20.23		A609
	1200	575	215T	E004	215TTFC6081	✓	10:1	\$1,377	E9	90.2	5.8	176	19.61		N/A
7 1/2	3600	230/460	213T	E2115	213TTFW16001	✓	10:1	\$1,066	E9	90.2	17.8/8.9	116	20.97		A609
	3600	208-230/460	213T	U624A	213TTFC6002	✓	10:1	\$1,147	E9	90.2	19.8-18.0/9.0	147	18.19		N/A
	3600	230/460	213T	E218	213TTTS6001		2:1	\$1,184	E9	90.2	17.8/8.9	185	15.69	N,NE	A206
	3600	575	213T	E2140	213TTFW16020		10:1	\$1,066	E9	90.2	7.1	116	20.97		A609
	3600	575	213T	U671A	213TTFC6006	✓	10:1	\$1,147	E9	90.2	7.3	147	18.19		N/A
	1800	230/460	213T	E2116	213TTFW16026	✓	10:1	\$1,000	E9	91.7	21.6/10.8	144	18.70		A667
	1800	208-230/460	213T	U629A	213TTFC6027	✓	10:1	\$1,074	E9	91.7	20.5-18.6/9.3	155	18.19		N/A
	1800	575	213T	E2141	213TTFW16040	✓	10:1	\$1,000	E9	91.7	8.6	144	18.70		A667
	1800	575	213T	U631A	213TTFC6031	✓	10:1	\$1,074	E9	91.7	8.9	155	18.19		N/A
	1200	230/460	254T	E2117	254TTFL16076	✓	10:1	\$1,744	E9	91.0	19.8/9.9	162	23.40		A1209
	1200	208-230/460	254T	U633A	254TTFC6077	✓	10:1	\$1,806	E9	91.0	24.2-22.2/11.1	249	23.19		N/A
	1200	230/460	254T	E235	254TTFNA6076		20:1	\$1,872	E9	91.0	19.8/9.9	223	23.52		A284
	1200	575	254T	E2142	254TTFL16077		10:1	\$1,744	E9	91.0	7.9	162	23.40		A1209
	1200	575	254T	E005	254TTFC6081	✓	10:1	\$1,806	E9	91.0	8.5	249	23.19		N/A

Catalog numbers (Cat No.) highlighted in bold blue have efficiency levels that meet EISA requirements

Blue shaded areas are Cast Iron Frames

* Requires nameplate modification

Continued on next page.



NEMA Premium® XRI® Efficiency

Three Phase, Totally Enclosed

Rigid Base

HP	RPM	VOLTS	FRAME	CAT. NO.	MODEL NO.	STOCK	CT SPEED RANGE*	LIST PRICE	MULT. SYMB.	NOM. EFF.	F.L. AMPS	WEIGHT	"C" DIM.	FOOT NOTES	C FACE KITS
10	3600	230/460	215T	E2118	215TTFW16001	✓	10:1	\$1,176	E9	91.7	23.6/11.8	137	22.22		A609
	3600	208-230/460	215T	U636A	215TTF6002	✓	10:1	\$1,286	E9	91.7	25.7-23.4/11.7	181	19.61		N/A
	3600	575	215T	E2143	215TTFW16020		10:1	\$1,176	E9	91.7	9.4	137	22.22		A609
	3600	575	215T	U637A	215TTF6006	✓	10:1	\$1,286	E9	91.7	9.6	181	19.61		N/A
	1800	230/460	215T	E2119	215TTFW16026	✓	10:1	\$1,138	E9	91.7	26.8/13.4	161	19.70		A667
	1800	208-230/460	215T	U639A	215TTF6027	✓	10:1	\$1,190	E9	91.7	27.5-25.0/12.5	177	19.61		N/A
	1800	575	215T	E2144	215TTFW16040	✓	10:1	\$1,138	E9	91.7	10.7	161	19.70		A667
	1800	575	215T	U641A	215TTF6031	✓	10:1	\$1,190	E9	91.7	10.3	177	19.61		N/A
	1800	575	215T	E306	215TTF6030		20:1	\$1,353	E9	91.7	10.0	225	19.70		A206
	1200	230/460	256T	E2120	256TTF16076	✓	10:1	\$2,153	E9	91.0	26.2/13.1	185	25.15		A1209
	1200	208-230/460	256T	U642A	256TTF6077	✓	10:1	\$2,244	E9	91.0	32.4-29.9/14.5	300	24.92		N/A
	1200	230/460	256T	E236	256TTFNA6076		20:1	\$2,287	E9	91.0	26.2/13.1	368	25.27		A284
	1200	575	256T	E2145	256TTF16077		10:1	\$2,153	E9	91.0	10.5	185	25.15		A1209
	1200	575	256T	E006	256TTF6081	✓	10:1	\$2,244	E9	91.0	11.6	300	24.92		N/A
15	3600	230/460	254T	E2121	254TTF16001	✓	10:1	\$1,672	E9	91.0	35.4/17.7	162	22.99		A1209
	3600	208-230/460	254T	U644A	254TTF6002	✓	10:1	\$1,719	E9	91.0	38.5-35.0/17.5	200	19.61		N/A
	3600	230/460	254T	E220	254TTFNA6001		2:1	\$1,815	E9	91.7	35.0/17.5	350	23.52		A284
	3600	575	254T	E2146	254TTF16020		10:1	\$1,672	E9	91.0	14.2	162	22.99		A1209
	3600	575	254T	U638A	254TTF6006	✓	10:1	\$1,719	E9	91.0	14.3	200	19.61		N/A
	1800	230/460	254T	E2122	254TTF16026	✓	10:1	\$1,554	E9	92.4	38.1/19.1	174	22.99		A1209
	1800	208-230/460	254T	U647B	254TTF6027	✓	10:1	\$1,640	E9	92.4	39.6-36.0/18.0	280	23.19		N/A
	1800	230/460	254T	E205	254TTFNA6026		20:1	\$1,704	E9	92.4	37.6/18.8	350	23.52		A284
	1800	575	254T	E2147	254TTF16040	✓	10:1	\$1,554	E9	92.4	15.8	174	22.99		A1209
	1800	575	254T	U648A	254TTF6031	✓	10:1	\$1,640	E9	92.4	15.6	280	23.19		N/A
	1800	575	254T	E307	254TTFNA6030		20:1	\$1,704	E9	92.4	15.1	350	23.52		A284
	1200	230/460	284T	E237	284TTFNA6076	✓	20:1	\$3,035	E9	91.7	40.8/20.4	475	26.34		A618
	1200	208-230/460	284T	E978A	284TTF6077	✓	10:1	\$3,035	E9	91.7	44.7-40.6/20.3	333	26.26		N/A
	1200	575	284T	E007	284TTF6081	✓	10:1	\$3,035	E9	91.7	34.1	333	26.26		N/A
20	3600	230/460	256T	E2123	256TTF16002	✓	10:1	\$2,249	E9	91.0	47.0/23.5	186	24.74		A1209
	3600	208-230/460	256T	U649A	256TTF6002	✓	10:1	\$2,351	E9	91.0	50.6-46.0/23.0	316	24.92		N/A
	3600	230/460	256T	E221	256TTFNA6001		2:1	\$2,351	E9	92.4	46.8/23.4	375	25.27		A284
	3600	575	256T	E2148	256TTF16020		10:1	\$2,249	E9	91.0	18.9	186	26.24		A1209
	3600	575	256T	U650A	256TTF6006	✓	10:1	\$2,351	E9	91.0	18.5	316	24.92		N/A
	1800	230/460	256T	E2124	256TTF16033	✓	10:1	\$1,935	E9	93.0	48.6/24.3	191	26.24		A1209
	1800	208-230/460	256T	U652B	256TTF6027	✓	10:1	\$2,044	E9	93.0	53.9-49.0/24.5	322	24.92		N/A
	1800	230/460	256T	E206	256TTFNA6026	✓	20:1	\$2,123	E9	93.0	48.2/24.1	425	25.27	d	A284
	1800	575	256T	E2149	256TTF16040	✓	10:1	\$1,935	E9	93.0	20.4	191	26.24		A1209
	1800	575	256T	U653A	256TTF6031	✓	10:1	\$2,044	E9	93.0	20.2	322	24.92		N/A
	1800	575	256T	E308	256TTFNA6030		20:1	\$2,123	E9	93.0	19.3	425	25.27		A284
	1200	230/460	286T	E238	286TTFNA6076	✓	20:1	\$3,698	E9	91.7	53.6/26.8	550	27.84		A618
	1200	208-230/460	286T	E968A	286TTF6077	✓	10:1	\$3,698	E9	91.7	59.4-54.0/27.0	392	27.83		N/A
	1200	575	286T	E008	286TTF6081	✓	10:1	\$3,698	E9	91.7	45.4	550	27.84		N/A
25	3600	230/460	284TS	E222	284TSTFNA6001	✓	2:1	\$2,771	E9	93.6	56.2/28.1	475	24.97		A618
	3600	208-230/460	284TS	E975A	284TSTFC6002	✓	10:1	\$2,771	E9	91.7	62.3-56.8/28.4	383	24.88		N/A
	3600	575	284TS	U654A	284TSTFC6006	✓	10:1	\$2,771	E9	91.7	23.8	383	24.88		N/A
	1800	230/460	284T	E207	284TTFNA6026	✓	20:1	\$2,528	E9	93.6	62.0/31.0	500	26.34		A618
	1800	208-230/460	284T	E961C	284TTF6027	✓	10:1	\$2,528	E9	93.6	64.9-59.0/29.5	385	26.26		N/A
	1800	208-230/460	284TS	E999A	284TSTFC6036	✓	10:1	\$2,528	E9	93.6	64.9-59.0/29.5	385	26.26		N/A
	1800	575	284T	E309	284TTFNA6030	✓	20:1	\$2,528	E9	93.6	24.8	500	26.34		A618
	1800	575	284T	E800A	284TTF6031	✓	10:1	\$2,528	E9	93.6	23.6	385	26.26		N/A
	1200	230/460	324T	E239	324TTF6076	✓	20:1	\$4,482	E9	93.0	65.0/32.5	675	28.87		A214
	1200	208-230/460	324T	E820A	324TTF6077	✓	10:1	\$4,482	E9	93.0	72.6-66.0/33.0	545	29.53		N/A
	1200	575	324T	E009	324TTF6081	✓	10:1	\$4,482	E9	93.0	27.2	545	29.53		N/A
30	3600	230/460	286TS	E223	286TSTFNA6001	✓	2:1	\$3,236	E9	93.6	67.6/33.8	500	26.47		A618
	3600	208-230/460	286TS	E964A	286TSTFC6002	✓	10:1	\$3,236	E9	91.7	74.4-67.6/33.8	385	26.46		N/A
	3600	575	286TS	E819A	286TSTFC6006	✓	10:1	\$3,236	E9	91.7	28.4	385	26.46		N/A
	1800	230/460	286T	E208	286TTFNA6026	✓	20:1	\$2,940	E9	94.1	73.0/36.5	525	27.84		A618
	1800	208-230/460	286T	E983B	286TTF6027	✓	10:1	\$2,940	E9	93.6	77.070.0/35.0	432	27.83		N/A
	1800	208-230/460	286TS	E818A	286TSTFC6036	✓	10:1	\$2,940	E9	93.6	77.070.0/35.0	432	27.83		N/A
	1800	575	286T	E310	286TTFNA6030	✓	20:1	\$2,940	E9	94.1	29.2	525	27.84		A618

Catalog numbers (Cat No.) highlighted in bold blue have efficiency levels that meet EISA requirements

Blue shaded areas are Cast Iron Frames

* Requires nameplate modification

@ Requires larger fan

Continued on next page.

GENERAL PURPOSE THREE PHASE

NEMA Premium® XRI® Efficiency

Three Phase, Totally Enclosed

Rigid Base

HP	RPM	VOLTS	FRAME	CAT. NO.	MODEL NO.	STOCK	CT SPEED RANGE*	LIST PRICE	MULT. SYMB.	NOM. EFF.	F.L. AMPS	WEIGHT	"C" DIM.	FOOT NOTES	C FACE KITS	
30	1800	575	286T	E817A	286TTFC6031	✓	10:1	\$2,940	E9	93.6	29.7	432	27.83		N/A	
	1200	230/460	326T	E240	326TTFS6076	✓	20:1	\$5,162	E9	93.0	77.0/38.5	725	30.37		A214	
	1200	208-230/460	326T	E966A	326TTFC6077	✓	10:1	\$5,162	E9	93.0	84.9-77.2/38.6	615	31.02		N/A	
	1200	575	326T	E010	326TTFC6081	✓	10:1	\$5,162	E9	93.0	32.4	615	31.02		N/A	
40	3600	230/460	324TS	E224	324TSTFS6001	✓	2:1	\$4,267	E9	93.6	94.0/47.0	675	27.37		A214	
	3600	208-230/460	324TS	E971A	324TSTFC6002	✓	10:1	\$4,267	E9	92.4	97.9-89.0/44.5	504	28.03		N/A	
	3600	575	324TS	E319	324TSTFS6005	✓	2:1	\$4,267	E9	94.1	37.5	675	27.37		A214	
	3600	575	324TS	E011	324TSTFC6006	✓	10:1	\$4,267	E9	92.4	35.4	504	28.03		N/A	
	1800	230/460	324T	E209	324TTFS6026	✓	20:1	\$3,905	E9	94.1	95.0/47.5	750	30.37		A214	
	1800	208-230/460	324T	E984B	324TTFC6027	✓	10:1	\$3,905	E9	94.1	101-92.0/46.0	528	29.53		N/A	
	1800	208-230/460	324TS	E816A	324TSTFC6036	✓	10:1	\$3,905	E9	94.1	101-92.0/46.0	528	29.53		N/A	
	1800	575	324T	E311	324TTFS6030	✓	20:1	\$3,905	E9	94.1	39.0	750	30.37		A214	
	1800	575	324T	E815A	324TTFC6031	✓	10:1	\$3,905	E9	94.1	37.8	528	29.53		N/A	
	1200	230/460	364T	E241A	364TTFS16083	✓	20:1@	\$7,637	E9	94.1	100/50.0	950	31.50		A395	
	1200	208-230/460	364T	E988A	364TTFC6087	✓	10:1	\$7,637	E9	94.1	112-102/51.0	636	32.64		N/A	
	50	1200	575	364T	E012	364TTFC6081	✓	10:1	\$7,637	E9	94.1	42.8	636	32.64		N/A
3600		230/460	326TS	E225	326TSTFS6001	✓	2:1	\$5,520	E9	93.6	116/58.0	725	28.87		A214	
3600		208-230/460	326TS	E976A	326TSTFC6002	✓	10:1	\$5,520	E9	93.0	122-111/55.5	554	29.53		N/A	
3600		575	326TS	E320	326TSTFS6005	✓	2:1	\$5,520	E9	94.5	46.5	725	28.87		A214	
3600		575	326TS	E013	326TSTFC6006	✓	10:1	\$5,520	E9	93.0	44.5	554	29.53		N/A	
1800		230/460	326T	E210	326TTFS6026	✓	20:1@	\$4,796	E9	94.5	120/60.0	775	31.87		A214	
1800		208-230/460	326T	E962B	326TTFC6027	✓	10:1	\$4,796	E9	94.5	129-117/58.5	587	31.02		N/A	
1800		208-230/460	326TS	E801A	326TSTFC6036	✓	10:1	\$4,796	E9	94.5	129-117/58.5	587	31.02		N/A	
1800		575	326T	E312	326TTFS6030	✓	20:1@	\$4,796	E9	94.5	48.0	775	31.87		A214	
1800		575	326T	U659A	326TTFC6031	✓	10:1	\$4,796	E9	94.5	47.9	587	31.02		N/A	
1200		230/460	365T	E242A	365TTFS16083	✓	20:1@	\$8,569	E9	94.1	123/61.5	1000	32.50		A395	
1200		208-230/460	365T	E993A	365TTFC6087	✓	10:1	\$8,569	E9	94.1	136-124/62	672	33.62		N/A	
60	1200	575	365T	E014	365TTFC6081	✓	10:1	\$8,569	E9	94.1	52.1	672	33.62		N/A	
	3600	230/460	364TS	E226	364TSTFS6001	✓	2:1	\$7,263	E9	94.5	134/67.0	925	29.38		A396	
	3600	208-230/460	364TS	E960A	364TSTFC6002	✓	10:1	\$7,263	E9	93.6	149-136/68.0	735	30.51		N/A	
	3600	575	364TS	E321	364TSTFS6005	✓	2:1	\$7,263	E9	94.5	53.5	925	29.38		A396	
	3600	575	364TS	E015	364TSTFC6006	✓	10:1	\$7,263	E9	93.6	53.7	735	30.51		N/A	
	1800	230/460	364T	E211	364TTFS6036	✓	20:1@	\$6,880	E9	95.0	138/69.0	1000	31.50		A395	
	1800	208-230/460	364T	E985B	364TTFC6037	✓	10:1	\$6,880	E9	95.0	151-137/68.5	666	32.64		N/A	
	1800	208-230/460	364TS	E802A	364TSTFC6026	✓	10:1	\$6,880	E9	95.0	151-137/68.5	666	32.64		N/A	
	1800	575	364T	E313	364TTFS6040	✓	20:1@	\$6,880	E9	95.0	55.0	1000	31.50		A395	
	1800	575	364T	U660A	364TTFC6041	✓	10:1	\$6,880	E9	95.0	55.6	666	32.64		N/A	
	1200	230/460	404T	E243	404TTFS6086	✓	20:1@	\$9,414	E9	94.5	144/72.0	1200	35.62		A223	
	75	3600	230/460	365TS	E227	365TSTFS6001	✓	2:1	\$9,120	E9	94.5	168/84.0	1025	30.38		A396
3600		208-230/460	365TS	E991A	365TSTFC6003	✓	10:1	\$9,120	E9	93.6	186-169/84.5	780	31.50		N/A	
3600		575	365TS	E322	365TSTFS6002	✓	2:1	\$9,120	E9	94.5	67.0	1025	30.38		A396	
3600		575	365TS	E016	365TSTFC6006	✓	10:1	\$9,120	E9	93.6	67.3	780	31.50		N/A	
1800		230/460	365T	E212	365TTFS6036	✓	20:1@	\$8,722	E9	95.4	172/86.0	1100	32.50		A395	
1800		208-230/460	365T	E957A	365TTFC6037	✓	10:1	\$8,722	E9	95.4	188-171/85.5	733	33.62		N/A	
1800		208-230/460	365TS	E804A	365TSTFC6026	✓	10:1	\$8,722	E9	95.4	188-171/85.5	733	33.62		N/A	
1800		575	365T	E315	365TTFS6040	✓	20:1@	\$8,722	E9	95.4	69.0	1100	32.50		A395	
1800		575	365T	E805A	365TTFC6041	✓	10:1	\$8,722	E9	95.4	71.0	733	33.62		N/A	
1200		230/460	405T	E244	405TTFS6086	✓	20:1@	\$11,081	E9	94.5	180/90	1300	37.12		A223	
100		3600	230/460	405TS	E228	405TSTFS6001	✓	2:1	\$12,220	E9	95.0	216/108	1250	34.12		A226
		3600	575	405TS	E323	405TSTFS6005	✓	2:1	\$12,220	E9	95.0	86.5	1250	34.12		A226
	1800	230/460	405T	E213	405TTFS6036	✓	20:1@	\$10,776	E9	95.4	226/113	1375	37.12		A223	
	1800	230/460	405TS	E808A	405TSTFS16033	✓	20:1@	\$10,776	E9	95.4	226/113	1375	34.12		A226	
	1800	575	405T	E314	405TTFS6040	✓	20:1@	\$10,776	E9	95.4	90.5	1375	37.12		A223	
	1200	230/460	444T	E328	444TTFN6086	✓	20:1@	\$16,341	E9	95.0	248/124	2000	41.25		A620	
125	3600	460	444TS	E229	444TSTFS6001	✓	2:1	\$15,975	E9	95.4	136	1750	37.50	PW	N/A	
	3600	575	444TS	E324	444TSTFS16002	✓	2:1	\$15,975	E9	95.4	109	1750	37.50	PW	A232	
	1800	460	444T	E214	444TTFS6036	✓	20:1@	\$14,186	E9	95.4	141	1850	41.25	PW	A229	
	1800	460	444TS	E810A	444TSTFN16033	✓	20:1@	\$14,186	E9	95.4	141	1850	37.50		A621	
	1800	575	444T	E316	444TTFS6044	✓	20:1@	\$14,186	E9	95.4	113	1850	41.25	PW	A229	
	1200	460	445T	E246	445TTFN6086	✓	20:1@	\$18,603	E9	95.0	155	2050	43.19		A620	

GENERAL PURPOSE THREE PHASE

Catalog numbers (Cat No.) highlighted in bold blue have efficiency levels that meet EISA requirements

Blue shaded areas are Cast Iron Frames

* Requires nameplate modification

@ Requires larger fan

Continued on next page.



NEMA Premium® XRI® Efficiency

Three Phase, Totally Enclosed

Rigid Base

HP	RPM	VOLTS	FRAME	CAT. NO.	MODEL NO.	STOCK	CT SPEED RANGE*	LIST PRICE	MULT. SYMB.	NOM. EFF.	F.L. AMPS	WEIGHT	"C" DIM.	FOOT NOTES	C FACE KITS
150	3600	460	445TS	E230	445TSTFN6001	✓	2:1	\$19,191	E9	95.8	165	2050	39.44		A621
	1800	460	445T	E215	445TTFN6036	✓	20:1@	\$16,493	E9	95.8	172	2050	43.19		A620
	1800	460	445TS	E811A	445TSTFN6026	✓	20:1@	\$16,493	E9	95.8	172	2050	39.60	68	A621
	1800	575	445T	E317	445TTFN6037		20:1@	\$16,493	E9	95.8	138	2050	43.19	PW	A620
	1200	460	445T	E289	445TTFN6087		20:1@	\$20,813	E9	95.8	181	2500	43.19	RB	N/A
200	3600	460	445TS	E342	445TSTFN16004	✓	2:1	\$24,277	E9	95.8	222	2300	39.44		A621
	1800	460	445T	E247	445TTFN6038	✓	20:1@	\$20,058	E9	96.2	226	2350	43.19	RB	N/A
	1800	460	445TS	E813A	445TSTFN16033	✓	20:1@	\$20,058	E9	96.2	226	2350	39.60		A620
	1800	575	445T	E326	445TTFN6039		20:1@	\$20,058	E9	96.2	181	2350	43.19	RB	N/A
	1200	460	447/9T	E282	449TTFS6088	✓	20:1@	\$25,479	E9	95.8	240	2900	51.69	H, RB	N/A
250	3600	460	447/9TS	E271	449TSTFS6003		2:1	\$30,617	E9	96.5	274	2700	47.88	H	A624
	1800	460	445T	E287	445TTFN6040		20:1@	\$23,645	E9	95.8	285	2150	43.35	RB, X	N/A
	1800	460	447/9T	E276	449TTFS6038		20:1@	\$25,419	E9	96.5	285	2850	51.69	H, RB	N/A
	1200	460	L447/9T	E283	449TTFS6087		20:1@	\$29,288	E9	95.8	300	3350	51.69	H, RB	N/A
300	3600	460	447/9TS	E272	449TSTFS6002		2:1	\$39,686	E9	96.2	330	2700	47.88	H	A624
	1800	460	447/9T	E277	449TTFS6037		20:1@	\$28,756	E9	96.5	339	3150	51.69	H, RB	N/A
	1200	460	L447/9T	E284	449TTFS6390		N/A	\$38,669	E9	95.8	362	3850	56.71	H, RB	N/A
350	3600	460	447/9TS	E273	449TSTFS6001		2:1	\$45,511	E9	96.2	382	2950	47.88		A624
	1800	460	447/9T	E293	449TTFS16333		2:1	\$37,524	E9	96.2	395	3400	51.88	H, RB	N/A
400	1800	460	447/9T	E291	449TTFS16334		2:1	\$37,865	E9	96.5	460	3800	56.71	H	A623
450	1800	460	L447/9T	E292	449TTFS6065		N/A	\$38,822	E9	96.5	515	3800	56.71	H	A623

* Requires nameplate modification
@ Requires larger fan

C-Face Footed (Rigid Base)

HP	RPM	VOLTS	FRAME	CAT. NO.	MODEL NO.	STOCK	CT SPEED RANGE	LIST PRICE	MULT. SYMB.	NOM. EFF.	F.L. AMPS	WEIGHT	"C" DIM.	FOOT NOTES
1	3600	208-230/460	56C	E2000	56T34F5940	✓	10:1	\$592	E9	80.0	3.0-2.8/1.4	28	11.31	
	1800	208-230/460	143TC	E2001	143TTFR5642	✓	10:1	\$476	E9	85.5	3.2-3.2/1.6	40	13.75	
	1200	208-230/460	145TC	E2002	145TTFR6078	✓	10:1	\$573	E9	82.5	3.8-3.8/1.9	45	13.75	
1 1/2	3600	208-230/460	143TC	E2003	143TTFR5582	✓	10:1	\$551	E9	84.0	4.4-4.0/2.0	38	13.75	
	1800	208-230/460	145TC	E2004	145TTFR6033	✓	10:1	\$518	E9	86.5	5.2-4.8/2.4	45	13.75	
	1200	208-230/460	182TC	E2005	182TTFW6076	✓	10:1	\$749	E9	87.5	6.0-5.1/2.6	82	14.47	13
2	3600	208-230/460	145TC	E2006	145TTFR3002	✓	10:1	\$610	E9	85.5	5.2-4.8/2.4	48	13.75	
	1800	208-230/460	145TC	E2007	145TTFR6035	✓	10:1	\$568	E9	86.5	6.0-5.8/2.9	50	14.25	
	1200	208-230/460	184TC	E2008	184TTFW6076	✓	10:1	\$858	E9	88.5	7.4-6.4/3.2	94	14.97	13
3	3600	208-230/460	182TC	E2009A	182TTFR6001	✓	10:1	\$791	E9	87.5	8.0-7.6/3.8	81	15.69	d
	3600	208-230/460	182TC	E2009	182TTFW6001	✓	10:1	\$791	E9	87.5	8.4-7.8/3.9	81	13.97	13
	1800	208-230/460	182TC	E2010	182TTFW6026	✓	10:1	\$710	E9	89.5	8.4-7.8/3.9	87	13.97	13
	1200	208-230/460	213TC	E2011	213TTFW6076	✓	10:1	\$1,047	E9	89.5	9.2-8.8/4.4	125	19.47	
5	3600	208-230/460	184TC	E2012	184TTFW6001	✓	10:1	\$917	E9	88.5	13.0-12.0/6.0	85	17.19	13
	1800	208-230/460	184TC	E2013	184TTFW6026	✓	10:1	\$828	E9	90.2	13.7-12.6/6.3	87	14.97	13
	1200	208-230/460	215TC	E2014	215TTFW6076	✓	10:1	\$1,348	E9	90.2	15.0-14.0/7.0	160	20.97	
7 1/2	3600	208-230/460	213TC	E2015	213TTFW6001	✓	10:1	\$1,127	E9	91.7	19.7-17.8/8.9	116	20.97	
	1800	208-230/460	213TC	E2016	213TTFW6026	✓	10:1	\$1,023	E9	91.7	21.0-19.4/9.7	143	20.97	
10	3600	208-230/460	215TC	E2018	215TTFW6001	✓	10:1	\$1,199	E9	91.7	26.4-23.6/11.8	230	22.22	
	1800	208-230/460	215TC	E2019	215TTFW6026	✓	10:1	\$1,164	E9	91.7	28.0-25.6/12.8	164	22.22	

Catalog numbers (Cat No.) highlighted in bold blue have efficiency levels that meet EISA requirements

Blue shaded areas are Cast Iron Frames

GENERAL PURPOSE THREE PHASE

General Purpose, Three Phase Globetrotter® NEMA Premium® Efficiency Totally Enclosed

Features:

☛ Meets or exceeds NEMA Premium® efficiencies

NEMA Premium® models are in compliance with EISA2007

- Cast iron frame and brackets
- Inverter Duty 10:1 Variable Torque and 10:1 Constant Torque, 1.0 SF
- 1.15 Service Factor
- Class F Insulation
- Standard assembly F1, reversible to F2 assembly
- UL Recognized, CSA Certified, CE Mark
- Two year warranty



Rigid Base

HP	RPM	VOLTS	FRAME	CAT. NO.	MODEL NO.	STOCK	LIST PRICE	MULT. SYMB.	NOM. EFF.	F.L. AMPS	APPROX WGT. LBS	"C" DIM.	FOOT NOTES	C FACE KITS
1 1/2	1200	208-230/460	182T	GT1005	182TTFC6076	✓	\$697	E1	87.5	4.8/2.4	89	14.80	75	A644
	1200	575	182T	GT1105	182TTFC6080	✓	\$697	E1	87.5	1.9	89	14.80	75	A644
2	1200	208-230/460	184T	GT1008	184TTFC6076	✓	\$824	E1	88.5	6.0/3.0	125	15.81	75	A644
	1200	575	184T	GT1108	184TTFC6080	✓	\$824	E1	88.5	2.4	125	15.81	75	A644
3	3600	208-230/460	182T	GT1009	182TTFC6001	✓	\$866	E1	86.5	7.6/3.8	94	14.80	A, 75	A644
	3600	575	182T	GT1109	182TTFC6005	✓	\$866	E1	86.5	3.1	94	14.80	75	A644
	1800	208-230/460	182T	GT1010	182TTFC6026	✓	\$777	E1	89.5	7.8/3.9	102	14.80	75	A644
	1800	575	182T	GT1110	182TTFC6030	✓	\$777	E1	89.5	3.1	102	14.80	75	A644
	1200	208-230/460	213T	GT1011	213TTFC6076	✓	\$1,178	E1	89.5	8.6/4.3	173	18.23	75	A206
	1200	575	213T	GT1111	213TTFC6080	✓	\$1,178	E1	89.5	3.5	173	18.23	75	A206
5	3600	208-230/460	184T	GT1012	184TTFC6001	✓	\$963	E1	88.5	12.0/6.0	109	15.81	A, 75	A644
	3600	575	184T	GT1112	184TTFC6005	✓	\$963	E1	88.5	4.8	109	15.81	75	A644
	1800	208-230/460	184T	GT1013	184TTFC6026	✓	\$901	E1	90.2	12.4/6.2	117	15.81	A, 75	A644
	1800	575	184T	GT1113	184TTFC6030	✓	\$901	E1	89.5	5.0	117	15.81	75	A644
	1200	208-230/460	215T	GT1014	215TTFC6076	✓	\$1,447	E1	90.2	14/7.0	203	19.73	75	A206
	1200	575	215T	GT1114	215TTFC6080	✓	\$1,447	E1	89.5	5.6	203	19.73	75	A206
7 1/2	3600	208-230/460	213T	GT1015	213TTFC6001	✓	\$1,163	E1	89.5	17.8/8.9	185	18.23	A, 75	A206
	3600	575	213T	GT1115	213TTFC6005	✓	\$1,163	E1	89.5	7.1	185	18.23	75	A206
	1800	208-230/460	213T	GT1016	213TTFC6026	✓	\$1,104	E1	91.7	18.6/9.3	194	18.23	75	A206
	1800	575	213T	GT1116	213TTFC6030	✓	\$1,104	E1	91.7	7.5	194	18.23	75	A206
	1200	208-230/460	254T	GT1017	254TTFCA6076	✓	\$1,839	E1	91.0	20.4/10.2	223	23.70	75	A173
	1200	575	254T	GT1117	254TTFCA6080	✓	\$1,839	E1	91.0	8.4	223	26.60	75	A173
10	3600	208-230/460	215T	GT1018	215TTFC6001	✓	\$1,358	E1	90.2	22.8/11.4	217	19.73	75	A171
	3600	575	215T	GT1118	215TTFC6005	✓	\$1,358	E1	90.2	9.1	217	19.73	75	A171
	1800	208-230/460	215T	GT1019	215TTFC6026	✓	\$1,329	E1	91.7	24.4/12.2	225	19.73	75	A171
	1800	575	215T	GT1119	215TTFC6030	✓	\$1,329	E1	91.7	9.8	225	19.73	75	A171
	1200	208-230/460	256T	GT1020	256TTFCA6076	✓	\$2,246	E1	91.0	26.8/13.4	368	25.43	75	A173
	1200	575	256T	GT1120	256TTFCA6080	✓	\$2,246	E1	91.0	11.2	368	27.80	75	A173
15	3600	208-230/460	254T	GT1021	254TTFCA6001	✓	\$1,783	E1	91.0	34/17.0	350	23.70	75	A172
	3600	575	254T	GT1121	254TTFCA6005	✓	\$1,783	E1	91.0	13.6	350	26.60	75	A172
	1800	208-230/460	254T	GT1022	254TTFCA6026	✓	\$1,674	E1	92.4	37/18.5	375	23.70	75	A173
	1800	575	254T	GT1122	254TTFCA6030	✓	\$1,674	E1	92.4	14.8	375	26.60	75	A173
	1200	208-230/460	284T	GT1023	284TTFCA6076	✓	\$2,981	E1	91.7	39.5/19.8	475	27.83	75	A175
	1200	575	284T	GT1123	284TTFCA6080	✓	\$2,981	E1	91.7	15.9	475	30.16	75	A175

Catalog numbers (Cat No.) highlighted in bold blue have efficiency levels that meet EISA requirements

Blue shaded areas are Cast Iron Frames

GENERAL PURPOSE THREE PHASE



General Purpose, Three Phase Globetrotter® NEMA Premium® Efficiency Totally Enclosed

Rigid Base

HP	RPM	VOLTS	FRAME	CAT. NO.	MODEL NO.	STOCK	LIST PRICE	MULT. SYMB.	NOM. EFF.	F.L. AMPS	APPROX WGT. LBS	"C" DIM.	FOOT NOTES	C FACE KITS
20	3600	208-230/460	256T	GT1024	256TTFCA6001	✓	\$2,209	E1	91.0	46.0/23.0	375	27.80		A172
	3600	575	256T	GT1124	256TTFCA6005	✓	\$2,209	E1	91.0	18.4	375	27.80		A172
	1800	208-230/460	256T	GT1025	256TTFCA6026	✓	\$2,085	E1	93.0	48.0/24.0	425	27.80		A173
	1800	575	256T	GT1125	256TTFCA6030	✓	\$2,085	E1	93.0	19.6	425	27.80		A173
	1200	208-230/460	286T	GT1026	286TTFCA6076	✓	\$3,632	E1	91.7	52.0/26.0	550	27.83		A175
	1200	575	286T	GT1126	286TTFCA6080	✓	\$3,632	E1	91.7	20.8	550	31.34		A175
25	3600	208-230/460	284TS	GT1027	284TSTFCA6001	✓	\$2,722	E1	91.7	55.5/27.7	475	28.82		A174
	3600	575	284TS	GT1127	284TSTFCA6005	✓	\$2,722	E1	91.7	22.4	475	28.82		A174
	1800	208-230/460	284T	GT1028	284TTFCA6026	✓	\$2,483	E1	93.6	62.0/31.0	500	27.83		A175
	1800	575	284T	GT1128	284TTFCA6030	✓	\$2,483	E1	93.6	24.4	500	30.16		A175
	1200	208-230/460	324T	GT1029	324TTFCA6076	✓	\$4,403	E1	93.0	66.0/33.0	675	32.68		A177
	1200	575	324T	GT1129	324TTFCA6080	✓	\$4,403	E1	93.0	26.8	675	32.68		A177
30	3600	208-230/460	286TS	GT1030	286TSTFCA6001	✓	\$3,178	E1	91.7	66.0/33.0	500	30.00		A174
	3600	575	286TS	GT1130	286TSTFCA6005	✓	\$3,178	E1	91.7	27.2	500	30.00		A174
	1800	208-230/460	286T	GT1031	286TTFCA6026	✓	\$2,888	E1	93.6	73.0/36.5	525	27.83		A175
	1800	575	286T	GT1131	286TTFCA6030	✓	\$2,888	E1	93.6	29.2	252	31.34		A175
	1200	208-230/460	326T	GT1032	326TTFCA6076	✓	\$5,070	E1	93.0	80.0/40.0	725	33.86		A177
	1200	575	326T	GT1132	326TTFCA6080	✓	\$5,070	E1	93.0	32.0	725	33.86		A177
40	3600	208-230/460	324TS	GT1033	324TSTFCA6001	✓	\$4,192	E1	92.4	88.0/44.0	675	31.26		A176
	3600	575	324TS	GT1133	324TSTFCA6005	✓	\$4,192	E1	92.4	35.0	675	31.26		A176
	1800	208-230/460	324T	GT1034	324TTFCA6026	✓	\$3,836	E1	94.1	94.0/47.0	750	32.68		A177
	1800	575	324T	GT1134	324TTFCA6030	✓	\$3,836	E1	94.1	37.5	750	32.68		A177
	1200	208-230/460	364T	GT1035	364TTFCA6086	✓	\$6,871	E1	94.1	94.0/47.0	950	36.61		A179
	1200	575	364T	GT1135	364TTFCA6080	✓	\$6,871	E1	94.1	38.5	950	36.61		A179
50	3600	208-230/460	326TS	GT1036	326TSTFCA6001	✓	\$5,422	E1	93.0	109/54.5	725	32.44		A176
	3600	575	326TS	GT1136	326TSTFCA6005	✓	\$5,422	E1	93.0	43.5	725	32.44		A176
	1800	208-230/460	326T	GT1037	326TTFCA6026	✓	\$4,710	E1	94.5	119/59.5	775	33.86		A177
	1800	575	326T	GT1137	326TTFCA6030	✓	\$4,710	E1	94.5	47.5	775	33.86		A177
	1200	208-230/460	365T	GT1038	365TTFCA6086	✓	\$7,892	E1	94.1	117/58.5	1000	38.39		A179
	1200	575	365T	GT1138	365TTFCA6080	✓	\$7,892	E1	94.1	47.0	1000	38.39		A179
60	3600	208-230/460	364TS	GT1039	364TSTFCA6001	✓	\$7,134	E1	93.6	132/66.0	925	34.57		A178
	3600	575	364TS	GT1139	364TSTFCA6005	✓	\$7,134	E1	93.6	53.0	925	34.57		A178
	1800	208-230/460	364T	GT1040	364TTFCA6036	✓	\$6,758	E1	95.0	138/69.0	1000	36.61		A179
	1800	575	364T	GT1140	364TTFCA6040	✓	\$6,758	E1	95.0	55.0	1000	36.61		A179
	1200	208-230/460	404T	GT1041	404TTFC6086	✓	\$9,246	E1	94.5	140/70.0	1200	42.72		A425
	1200	575	404T	GT1141	404TTFC6080	✓	\$9,246	E1	94.5	56.0	1200	42.72		A425
75	3600	208-230/460	365TS	GT1042	365TSTFCA6001	✓	\$8,958	E1	94.1	164/82.0	1025	36.34		A178
	3600	575	365TS	GT1142	365TSTFCA6002	✓	\$8,958	E1	93.6	65.5	1025	36.34		A178
	1800	208-230/460	365T	GT1043	365TTFCA6036	✓	\$8,567	E1	95.4	170/85.0	1100	38.39		A179
	1800	575	365T	GT1143	365TTFCA6040	✓	\$8,567	E1	95.4	69.0	1100	38.39		A179
	1200	208-230/460	405T	GT1044	405TTFC6086	✓	\$10,884	E1	94.5	174/87.0	1300	42.72		A425
	1200	575	405T	GT1144	405TTFC6080	✓	\$10,884	E1	94.5	69.5	1300	42.72		A425

Catalog numbers (Cat No.) highlighted in bold blue have efficiency levels that meet EISA requirements

Blue shaded areas are Cast Iron Frames

General Purpose, Three Phase Globetrotter® NEMA Premium® Efficiency Totally Enclosed

Rigid Base

HP	RPM	VOLTS	FRAME	CAT. NO.	MODEL NO.	STOCK	LIST PRICE	MULT. SYMB.	NOM. EFF.	F.L. AMPS	APPROX WGT. LBS	"C" DIM.	FOOT NOTES	C FACE KITS
100	3600	208-230/460	405TS	GT1045	405TSTFC6001	✓	\$12,003	E1	94.5	216/108	1250	39.76		A424
	3600	575	405TS	GT1145	405TSTFC6005	✓	\$12,003	E1	94.1	87.5	1250	39.76		A424
	1800	208-230/460	405T	GT1046	405TTFC6036	✓	\$10,584	E1	95.4	224/112	1375	42.72		A425
	1800	575	405T	GT1146	405TTFC6040	✓	\$10,584	E1	95.4	89.5	1375	42.72		A425
	1200	208-230/460	444T	GT1047	444TTFC6086	✓	\$16,050	E1	95.0	228/114	2000	50.79		A427
	1200	575	444T	GT1147	444TTFC6080	✓	\$16,050	E1	95.0	91	2000	50.79		A427
125	3600	460	444TS	GT1048	444TSTFC6001	✓	\$15,691	E1	95.0	136	1750	47.05		A426
	3600	575	444TS	GT1148	444TSTFC16002	✓	\$15,691	E1	95.0	109	1750	47.05		A426
	1800	460	444T	GT1049	444TTFC6036	✓	\$13,934	E1	95.4	140	1850	50.79		A427
	1800	575	444T	GT1149	444TTFC6044	✓	\$13,934	E1	95.4	112	1850	50.79		A427
	1200	460	445T	GT1050	445TTFC6086	✓	\$18,272	E1	95.0	142	2050	50.79		A427
	1200	575	445T	GT1150	445TTFC6080	✓	\$18,272	E1	95.0	114	2050	50.79		A427
150	3600	460	445TS	GT1051	445TSTFC6001	✓	\$18,850	E1	95.0	162	2050	47.05		A426
	3600	575	445TS	GT1151	445TSTFC6005	✓	\$18,850	E1	95.0	130	2050	47.05		A426
	1800	460	445T	GT1052	445TTFC6036	✓	\$16,199	E1	95.8	165	2050	50.79		A427
	1800	575	445T	GT1152	445TTFC6037	✓	\$16,199	E1	95.8	132	2050	50.79		A427
	1200	460	447T	GT1053	447TTFC6087	✓	\$20,444	E1	95.8	170	2500	55.91		A429
	1200	575	447T	GT1153	447TTFC6080	✓	\$20,444	E1	95.8	136	2500	55.91		A429
200	3600	460	447TS	GT1054	447TSTFC16004	✓	\$23,846	E1	95.4	215	2300	52.17		A428
	3600	575	447TS	GT1154	447TSTFC6005	✓	\$23,846	E1	95.4	172	2300	52.17		A428
	1800	460	447T	GT1055	447TTFC6038	✓	\$19,701	E1	96.2	225	2350	55.91		A429
	1800	575	447T	GT1155	447TTFC6039	✓	\$19,701	E1	96.2	180	2350	55.91	A	A429
	1200	460	449T	GT1056	449TTFC6088	✓	\$25,026	E1	95.8	228	2900	55.91		A429
	1200	575	449T	GT1156	449TTFC6080	✓	\$25,026	E1	95.8	182	2900	55.91		A429

Catalog numbers (Cat No.) highlighted in bold blue have efficiency levels that meet EISA requirements

Blue shaded areas are Cast Iron Frames



General Purpose, Three Phase Globetrotter® NEMA Premium® Efficiency

Totally Enclosed, C-Face Footless and C-Face Footed (Rigid Base)

Features:

☑ Meets or exceeds NEMA Premium® efficiencies

NEMA Premium® models are in compliance with EISA2007

- 182TC-215TC models steel frame, 254TC-405TC models cast iron frame and brackets
- Inverter Duty 10:1 Variable Torque and 10:1 Constant Torque, 1.0 SF
- 1.15 Service Factor
- Class F Insulation
- Standard assembly F1, reversible to F2 assembly
- UL Recognized, CSA Certified, CE Mark
- Two year warranty



C-Face Footless

HP	RPM	VOLTS	FRAME	CAT. NO.	MODEL NO.	STOCK	LIST PRICE	MULT. SYMB.	NOM. EFF.	F.L. AMPS	WEIGHT	"C" DIM.	FOOT NOTES
1 1/2	1200	208-230/460	182TC	GT1305	182TTFB6079	✓	\$887	E1	87.5	4.8/2.4	82	15.75	
2	1200	208-230/460	184TC	GT1308	184TTFB6079	✓	\$994	E1	88.5	6.0/3.0	94	16.73	
3	3600	208-230/460	182TC	GT1309	182TTFB6004	✓	\$928	E1	86.5	7.6/3.8	83	15.75	A
	1800	208-230/460	182TC	GT1310	182TTFB6029	✓	\$848	E1	89.5	7.8/3.9	87	15.75	
	1200	208-230/460	213TC	GT1311	213TTFBA6079	✓	\$1,179	E1	89.5	8.6/4.3	115	19.53	
5	3600	208-230/460	184TC	GT1312	184TTFB6004	✓	\$1,052	E1	88.5	13.4/6.7	95	16.73	A
	1800	208-230/460	184TC	GT1313	184TTFB6029	✓	\$965	E1	89.5	12.4/6.2	110	16.73	
	1200	208-230/460	215TC	GT1314	215TTFBA6079	✓	\$1,475	E1	89.5	14.0/7.0	135	21.02	
7 1/2	3600	208-230/460	213TC	GT1315	213TTFBA6004	✓	\$1,258	E1	89.5	17.8/8.9	116	19.53	
	1800	208-230/460	213TC	GT1316	213TTFBA6029	✓	\$1,011	E1	91.7	18.6/9.3	143	19.53	
10	3600	208-230/460	215TC	GT1318	215TTFBA6004	✓	\$1,329	E1	90.2	22.8/11.4	137	21.02	
	1800	208-230/460	215TC	GT1319	215TTFBA6029	✓	\$1,295	E1	91.7	24.4/12.2	164	21.02	

C-Face Footed (Rigid Base)

HP	RPM	VOLTS	FRAME	CAT. NO.	MODEL NO.	STOCK	LIST PRICE	MULT. SYMB.	NOM. EFF.	F.L. AMPS	WEIGHT	"C" DIM.	FOOT NOTES
1	1800	208-230/460	143TC	GT1201	143TTFR6032	✓	\$478	E1	85.5	3.3/1.65	59	13.87	
	1800	575	143TC	GT1401	143TTFR16039	✓	\$478	E1	85.5	1.3	59	13.87	A
	1200	208-230/460	145TC	GT1202	145TTFR16079	✓	\$626	E1	82.5	3.8-3.8/1.9	74	14.87	
1 1/2	3600	208-230/460	143TC	GT1203	143TTFR6010	✓	\$510	E1	84.0	4.0/2.0	63	13.87	
	3600	575	143TC	GT1403	143TTFR16003	✓	\$510	E1	84.0	1.6	63	13.37	
	1800	208-230/460	145TC	GT1204	145TTFR6058	✓	\$485	E1	86.5	4.6/2.3	68	14.37	
	1800	575	145TC	GT1404	145TTFR16046	✓	\$485	E1	86.5	2.0	68	14.37	A
	1200	208-230/460	182TC	GT1205	182TTFB6078	✓	\$701	E1	87.5	4.8/2.4	82	15.75	
	2	3600	208-230/460	145TC	GT1206	145TTFR6009	✓	\$559	E1	85.5	5.6-5.2/2.6	71	14.37
2	3600	575	145TC	GT1406	145TTFR16005	✓	\$559	E1	85.5	2.0	71	14.37	
	1800	208-230/460	145TC	GT1207	145TTFR6040	✓	\$520	E1	86.5	6.0/3.0	76	14.87	A
	1800	575	145TC	GT1407	145TTFR16047	✓	\$520	E1	86.5	2.4	76	14.87	A
	1200	208-230/460	184TC	GT1208	184TTFB6078	✓	\$803	E1	88.5	6.0/3.0	94	16.73	
	3	3600	208-230/460	182TC	GT1209	182TTFB6003	✓	\$740	E1	86.5	7.6/3.8	83	15.75
3	3600	575	182TC	GT1409	182TTFB6007	✓	\$740	E1	86.5	3.0	83	15.75	
	1800	208-230/460	182TC	GT1210	182TTFB6028	✓	\$697	E1	89.5	7.8/3.9	87	15.75	
	1800	575	182TC	GT1410	182TTFB6032	✓	\$697	E1	89.5	3.1	87	15.75	
	1200	208-230/460	213TC	GT1211	213TTFBA6078	✓	\$979	E1	89.5	8.6/4.3	115	19.53	

Catalog numbers (Cat No.) highlighted in bold blue have efficiency levels that meet EISA requirements

Continued on next page.

General Purpose, Three Phase Globetrotter® NEMA Premium® Efficiency IP44 - Totally Enclosed, C-Face Footed (Rigid Base) and C-Face Footless

HP	RPM	VOLTS	FRAME	CAT. NO.	MODEL NO.	STOCK	LIST PRICE	MULT. SYMB.	NOM. EFF.	F.L. AMPS	WEIGHT	"C" DIM.	FOOT NOTES
5	3600	208-230/460	184TC	GT1212	184TTFB6003	✓	\$858	E1	88.5	13.4/6.7	95	16.73	
	3600	575	184TC	GT1412	184TTFB6007	✓	\$858	E1	88.5	4.8	95	16.73	
	1800	208-230/460	184TC	GT1213	184TTFB6032	✓	\$775	E1	89.5	12.4/6.2	110	16.73	
	1800	575	184TC	GT1413	184TTFB3062	✓	\$775	E1	89.5	5.1	110	16.73	
	1200	208-230/460	215TC	GT1214	215TTFBA6078	✓	\$1,261	E1	89.5	14.0/7.0	135	21.02	
7 1/2	3600	208-230/460	213TC	GT1215	213TTFBA6003	✓	\$1,054	E1	89.5	17.8/8.9	116	19.53	A
	3600	575	213TC	GT1415	213TTFBA6007	✓	\$1,054	E1	89.5	7.1	116	19.53	
	1800	208-230/460	213TC	GT1216	213TTFBA6028	✓	\$957	E1	91.7	18.6/9.3	143	19.53	
	1800	575	213TC	GT1416	213TTFBA6032	✓	\$957	E1	91.7	8.6	143	19.53	
	1200	208-230/460	254TC	GT1217	254TTFCA6078	✓	\$1,945	E1	91.0	20.4/10.2	300	26.60	
10	3600	208-230/460	215TC	GT1218	215TTFBA6003	✓	\$1,122	E1	90.2	22.8/11.4	137	21.02	
	3600	575	215TC	GT1418	215TTFBA6007	✓	\$1,122	E1	90.2	9.4	137	21.02	
	1800	208-230/460	215TC	GT1219	215TTFBA6028	✓	\$1,089	E1	91.7	24.4/12.2	164	21.02	
	1800	575	215TC	GT1419	215TTFBA6032	✓	\$1,089	E1	91.7	10.7	164	21.02	
	1200	208-230/460	256TC	GT1220	256TTFCA6078	✓	\$2,333	E1	91.0	28.0/14.0	368	27.80	
15	3600	208-230/460	254TC	GT1221	254TTFCA6003	✓	\$1,892	E1	91.0	34.0/17.0	350	26.60	
	3600	575	254TC	GT1421	254TTFCA6007	✓	\$1,892	E1	91.0	14.2	350	26.60	
	1800	208-230/460	254TC	GT1222	254TTFCA6028	✓	\$1,788	E1	92.4	37.0/18.5	350	26.60	
	1800	575	254TC	GT1422	254TTFCA6032	✓	\$1,788	E1	92.4	15.8	350	26.60	
	1200	208-230/460	256TC	GT1224	256TTFCA6003	✓	\$2,298	E1	91.0	46.0/23.0	375	27.80	
20	1800	208-230/460	256TC	GT1225	256TTFCA6028	✓	\$2,180	E1	93.0	49.0/24.5	425	27.80	
	3600	208-230/460	284TSC	GT1227	284STFCA6003	✓	\$2,900	E1	91.7	56.0/28.0	475	28.79	
25	1800	208-230/460	284TC	GT1228	284TTFCA6028	✓	\$2,673	E1	93.6	61.0/30.5	500	30.16	
	3600	208-230/460	286TSC	GT1230	286STFCA6003	✓	\$3,335	E1	91.7	68.0/34.0	500	39.97	
30	1800	208-230/460	286TC	GT1231	286TTFCA6028	✓	\$3,058	E1	93.6	73.0/36.5	525	31.34	
	3600	208-230/460	324TSC	GT1233	324STFCA6003	✓	\$4,435	E1	92.4	88.0/44.0	675	31.18	
40	1800	208-230/460	324TC	GT1234	324TTFCA6028	✓	\$4,096	E1	94.1	94.0/47.0	750	32.68	
	3600	208-230/460	326TSC	GT1236	326STFCA6003	✓	\$5,607	E1	93.0	109/54.5	725	32.36	
50	1800	208-230/460	326TC	GT1237	326TTFCA6028	✓	\$4,929	E1	94.5	119/59.5	775	33.86	
	3600	208-230/460	364TSC	GT1239	364STFCA6003	✓	\$7,435	E1	93.6	132/66.0	925	34.48	
60	1800	208-230/460	364TC	GT1240	364TTFCA6038	✓	\$7,077	E1	95.0	138/69.0	1000	36.61	
	3600	208-230/460	365TSC	GT1242	365STFCA6003	✓	\$9,172	E1	93.6	164/82.0	1025	36.26	
75	1800	208-230/460	365TC	GT1243	365TTFCA6038	✓	\$8,800	E1	95.4	173/86.5	1100	38.39	
	3600	208-230/460	405TSC	GT1245	405STFC6003	✓	\$12,388	E1	94.5	224/112	1250	39.76	
100	1800	208-230/460	405TC	GT1246	405TTFC6038	✓	\$11,037	E1	95.4	224/112	1375	42.76	

Catalog numbers (Cat No.) highlighted in bold blue have efficiency levels that meet EISA requirements

Blue shaded areas are Cast Iron Frames

GENERAL PURPOSE THREE PHASE



Severe Duty, Totally Enclosed C-Face Footless, Three Phase

Features:

- 303 Stainless steel shafts with contact lip seal & V-ring slinger
- Rolled Steel construction
- Gray epoxy paint
- Class F insulation
- 1.15 Service Factor (except as noted)
- Automatic thermal protection

IP55

HP	RPM	VOLTS	FRAME	CAT. NO.	MODEL NO.	STOCK	LIST PRICE	MULT. SYMB.	NOM. EFF.	F.L. AMPS	WEIGHT	"C" DIM.	FOOT NOTES
1/2	1800	230/460	56C	K606	5K42GN4619	✓	\$472	F3	72.0	2.2/1.1	30	11.19	
3/4	1800	230/460	56C	K607	5K49MN4620	✓	\$518	F3	77.0	3.0/1.5	30	11.69	
1	1800	230/460	56C	K608	5K49MN4618	✓	\$542	F3	77.0	3.8/1.9	30	11.69	
1 1/2	1800	230/460	56C	K610	5K49RN4621	✓	\$598	F3	80.0	5.0/2.5	33	12.19	
2	1800	230/460	56C	K609	5K49TN4622	✓	\$637	F3	81.5	6.2/3.1	38	12.69	17

Catalog numbers (Cat No.) highlighted in bold blue have efficiency levels that meet EISA requirements

Blue Chip® Severe Duty / Cooling Tower: Single Speed Rigid Base, Three Phase

Features:

- Blue Chip® quality, 100% cast iron construction for rigidity and reduced vibration
- Internal and external epoxy paint
- Class F insulation
- 1.15 Service Factor
- Rated 60/50 hertz, 190/380 or 380 volt at next lower horsepower
- Extended grease tubes, regreasable in service
- T-drains provided for effective drainage (Installed in both endshields)
- Shaft Slinger
- Forsheda seals on both ends
- Ball Bearings
- Actual test and vibration data supplied with each motor
- UL Recognized and CSA Certified
- Suitable for 10:1 VT and CT (as noted) on VFD
- Two year warranty

IP55

Suitable for use on VFD per guidelines on page 17.

HP	RPM	VOLTS	FRAME	CAT. NO.	MODEL NO.	STOCK	CT SPEED RANGE*	LIST PRICE	MULT. SYMB.	NOM. EFF.	F.L. AMPS	WEIGHT	"C" DIM.	FOOT NOTES
3	1800	230/460	182T	U867A	182TTFN6557		10:1	\$986	S3	90.2	8.0/4.0	145	15.87	
5	1800	230/460	184T	U868A	184TTFN6555	✓	10:1	\$1,078	S3	90.2	12.4/6.2	128	17.87	
7 1/2	1800	230/460	213T	U869A	213TTFN6550	✓	10:1	\$1,360	S3	91.7	19.2/9.6	273	18.22	
10	1800	230/460	215T	U870A	215TTFN6546	✓	10:1	\$1,558	S3	91.7	25/12.5	267	19.72	
15	1800	230/460	254T	U871A	254TTFNA16568	✓	10:1	\$2,010	S3	92.4	37.5/18.8	349	23.52	
20	1800	230/460	256T	U872A	256TTFNA16574	✓	10:1	\$2,363	S3	93.0	48.0/24.1	375	25.27	
25	1800	230/460	284T	U873A	284TTFNA16832	✓	10:1	\$2,801	S3	93.6	62.0/31.0	440	26.34	
30	1800	230/460	286T	U874A	286TTFNA16572	✓	10:1	\$3,278	S3	94.1	73.0/36.5	503	27.84	
40	1800	230/460	324T	U875A	324TTFS16837	✓	2:1	\$4,249	S3	94.1	95.0/47.5	567	30.37	
50	1800	230/460	326T	U876A	326TTFS16574	✓	2:1	\$5,351	S3	94.5	120/60.0	644	30.37	
60	1800	230/460	364T	U877A	364TTFS16558	✓	2:1	\$7,489	S3	95.0	138/69.0	1078	31.50	
75	1800	230/460	365T	U878A	365TTFS16827	✓	2:1	\$9,323	S3	95.4	172/86.0	1169	32.50	
100	1800	230/460	405T	U879A	405TTFS16834	✓	2:1	\$11,545	S3	95.4	226/113	1458	37.12	
125	1800	460	444T	U880A	444TTFN16549	✓	2:1	\$14,863	S3	95.4	145	1990	43.35	
150	1800	460	445T	U881A	445TTFN16866	✓	2:1	\$17,698	S3	95.8	172	2343	43.35	
200	1800	460	445T	U882A	445TTFN16852		2:1	\$21,125	S3	96.2	226	2556	43.35	
250	1800	460	445T	U884	445TTFN4575		2:1	\$20,413	S3	95.0	285	2409	43.26	

Catalog numbers (Cat No.) highlighted in bold blue have efficiency levels that meet EISA requirements

Blue shaded areas are Cast Iron Frames

* Requires nameplate modification

Blue Chip® Severe Duty / Automotive Duty NEMA Premium® XRI®

Totally Enclosed, Rigid Base, Three Phase

Applications:

Chemical plants, paper mills, refineries, mines, food processing, foundries, and other severe duty environments where long life and ultra-high efficiency are desired. Guaranteed efficiencies offer an eXtra Return on your Investment when using these premium efficiency motors on high cycle or long run applications.



Features:

⊕ Meets or exceeds NEMA Premium® efficiencies, except where noted NEMA Premium® models are in compliance with EISA2007

- Blue Chip® quality, 100% cast iron construction for rigidity and reduced vibration
- Provisions to add stub shaft for an encoder (182T-449T, TEFC only)
- Internal and external epoxy paint
- MAX GUARD® Class F insulation system
- Constant Torque speed range is listed in CT SPEED RANGE column
- 1.15 Service Factor on sinewave , 1.0 Service Factor on IGBT power
- Bearing caps (254T and larger)
- Precision balanced to .08"/sec
- Extended grease tubes, regreasable in service
- Brass drain and breather
- Meets IEEE45 USCG Marine Duty, IP54 Construction
- Meets Ford EM1 Automotive Duty Specification
- Hazardous Duty™ Division 2 CSA certification nameplate
- Division 2 / Zone 2 Class I (gases), Groups A, B, C, D
- Meets temperature code T2B
- Actual test and vibration data supplied with each motor
- Ball bearings (except as noted)
- UL Recognized (through 449T) and CSA Certified and CE Marked
- Three year warranty

Models through 40 HP are capable of modification as follows (contact factory to confirm):

- 1.25 Service Factor (sinewave only)
- 50Hz at same HP, 1.0 Service Factor (sinewave only)
- Any nameplate changes are subject to modification charges (see MOD Central section)
- Contact Marathon Electric for optional nameplate markings on 50 HP and larger



Suitable for use on VFD per guidelines on page 17.

HP	RPM	VOLTS	FRAME	CAT. NO.	MODEL NO.	STOCK	CT SPEED RANGE*	LIST PRICE	MULT. SYMB.	NOM. EFF.	F.L. AMPS	WEIGHT	"C" DIM.	FOOT NOTES	C FACE KITS
3/4	1200	460	143T	E648	143TTTN6576	✓	1000:1	\$600	E9	80.0	1.4	53	10.43	75,76,N,NE	A603
	1200	460	143T	E373	143TTFN6576		20:1	\$660	E9	80.0	1.4	53	12.92	75,76,NE	A603
1	1800	460	143T	E649	143TTTN6526	✓	1000:1	\$490	E9	85.5	1.5	55	10.43	75,76,N,NE	A603
	1800	460	143T	E374	143TTFN6526		20:1	\$539	E9	85.5	1.5	71	12.92	75,76	A603
1	1800	230/460	143T	E461	143TTTN6563	✓	1000:1	\$490	E9	85.5	3.1/1.5	55	12.95	75,76,N,NE	A603
	1800	230/460	143T	E375	143TTFN6563		20:1	\$539	E9	85.5	3.1/1.5	71	12.95	75,76	A603
1	1800	575	143T	E666	143TTTN6530	✓	1000:1	\$490	E9	85.5	1.2	55	10.43	75,76,N,NE	A603
	1800	575	143T	E376	143TTFN16539		20:1	\$539	E9	85.5	1.2	71	14.17	75,76	A603
1	1200	460	145T	E650	145TTTN6576	✓	1000:1	\$616	E9	80.0	1.65	60	11.43	75,76,N,NE	A655
	1200	230/460	145T	E462	145TTTN6584		1000:1	\$616	E9	80.0	3.3/1.65	60	11.43	75,76,N,NE	A655
1 1/2	3600	460	143T	E651	143TTTN6501	✓	1000:1	\$613	E9	86.5	2.0	58	10.43	75,76,N,NE	A603
	3600	460	143T	E377	143TTFN6501		20:1	\$673	E9	85.5	2.0	64	14.17	75,76	A603
1 1/2	3600	230/460	143T	E463	143TTTN6502		1000:1	\$613	E9	86.5	4.0/2.0	58	10.43	75,76,N,NE	A603
	3600	230/460	143T	E378	143TTFN6502		20:1	\$673	E9	85.5	4.0/2.0	64	14.17	75,76	A603
1 1/2	3600	575	143T	E851	143TTTN6505		1000:1	\$613	E9	86.5	1.6	58	10.43	75,76,N,NE,d	A603
	3600	575	143T	E379	143TTFN6505		20:1	\$673	E9	85.5	1.6	64	14.17	75,76	A603
1 1/2	1800	460	145T	E652	145TTTN6526	✓	1000:1	\$531	E9	84.0	2.2	65	11.43	75,76,N,NE	A655
	1800	230/460	145T	E464	145TTTN6834	✓	1000:1	\$531	E9	84.0	4.4/2.2	65	11.43	75,76,N,NE	A655
1 1/2	1800	575	145T	E667	145TTTN6529		1000:1	\$531	E9	84.0	1.8	65	11.43	75,76,N,NE	A655
	1200	460	182T	E632	182TTTS6576	✓	1000:1	\$788	E9	87.5	2.2	100	12.71	75,76,N,NE	A644
1 1/2	1200	460	182T	E380	182TTFS6576		20:1	\$867	E9	87.5	2.2	110	15.19	75	A644
	1200	230/460	182T	E465	182TTTS6578		1000:1	\$788	E9	87.5	4.4/2.2	100	12.71	75,N,NE	A644
2	3600	460	145T	E653	145TTTN6501	✓	1000:1	\$642	E9	85.5	2.5	68	11.43	75,76,N,NE	A655
	3600	460	145T	E382	145TTFN6501		20:1	\$707	E9	85.5	2.0	80	14.17	75,76	A655
2	3600	230/460	145T	E466	145TTTN6521		1000:1	\$642	E9	85.5	5.0/2.5	68	11.43	75,76,N,NE	A655
	3600	230/460	145T	E383	145TTFN6521		20:1	\$707	E9	85.5	4.0/2.0	80	14.17	75,76	A655
2	3600	575	145T	E852	145TTTN6505		1000:1	\$642	E9	85.5	2.0	68	11.43	75,76,N,NE	A655

Catalog numbers (Cat No.) highlighted in bold blue have efficiency levels that meet EISA requirements

Blue shaded areas are Cast Iron Frames

* Requires nameplate modification
Continued on next page.



Blue Chip® Severe Duty / Automotive Duty NEMA Premium® XRI®

Totally Enclosed, Rigid Base, Three Phase

SEVERE DUTY

HP	RPM	VOLTS	FRAME	CAT. NO.	MODEL NO.	STOCK	CT SPEED RANGE*	LIST PRICE	MULT. SYMB.	NOM. EFF.	F.L. AMPS	WEIGHT	"C" DIM.	FOOT NOTES	C FACE KITS	
2	1800	460	145T	E654	145TTTN6527	✓	1000:1	\$584	E9	85.5	3.0	68	11.43	75,76,N,NE	A655	
	1800	230/460	145T	E467	145TTTN6835	✓	1000:1	\$584	E9	85.5	6.0/3.0	68	11.43	75,76,N,NE	A655	
	1800	230/460	145T	E386	145TTFN6835		20:1	\$642	E9	86.5	5.6/2.8	68	14.17	75,76	A655	
	1800	575	145T	E668	145TTTN6530		1000:1	\$584	E9	85.5	2.4	68	11.43	75,76,N,NE	A655	
	1200	460	184T	E633	184TTTS6576	✓	1000:1	\$974	E9	88.5	3.0	112	13.71	75,N,NE	A644	
	1200	460	184T	E388	184TTFS6576		20:1	\$1,071	E9	88.5	2.9	110	16.19	75	A644	
	1200	230/460	184T	E468	184TTTS6582	✓	1000:1	\$974	E9	88.5	6.0/3.0	112	13.71	75,N,NE	A644	
3	3600	460	182T	E601	182TTTS6501	✓	1000:1	\$882	E9	87.5	3.8	98	12.71	75,N,NE	A644	
	3600	230/460	182T	E390	182TTFS6501		20:1	\$971	E9	87.5	3.8	105	15.19	75	A644	
	3600	575	182T	E853	182TTTS6505		1000:1	\$882	E9	87.5	3.0	105	12.71	75,N,NE	A644	
	3600	575	182T	E392	182TTFS6505		20:1	\$971	E9	87.5	3.0	105	21.57	75	A644	
	1800	460	182T	E616	182TTTS6526	✓	1000:1	\$791	E9	90.2	4.0	102	12.71	75,N,NE	N/A	
	1800	230/460	182T	E470	182TTTS6538	✓	1000:1	\$791	E9	90.2	8.0/4.0	102	12.71	75,N,NE	N/A	
	1800	575	182T	E669	182TTTS6530	✓	1000:1	\$791	E9	90.2	3.2	102	12.71	75,N,NE	N/A	
	1200	460	213T	E634	213TTFS6576	✓	20:1	\$1,199	E9	89.5	4.4	176	18.22	75	A206	
	1200	230/460	213T	E471	213TTFS6594	✓	20:1	\$1,199	E9	89.5	8.8/4.4	176	18.22	75	A206	
	5	3600	460	184T	E602	184TTFS6501	✓	2:1	\$980	E9	89.5	5.9	142	16.19	75	A644
		3600	230/460	184T	E472	184TTFS6810	✓	2:1	\$980	E9	89.5	11.8/5.9	142	16.19	75	A644
		3600	575	184T	E655	184TTFS6505	✓	20:1	\$980	E9	89.5	4.7	142	16.19	75	A644
1800		460	184T	E617	184TTFS6526	✓	20:1	\$917	E9	90.2	6.2	130	16.19	75	A644	
1800		230/460	184T	E473	184TTFS6844	✓	20:1	\$917	E9	90.2	12.4/6.2	130	16.19	75	A644	
1800		575	184T	E670	184TTFS6530	✓	20:1	\$917	E9	90.2	5.0	130	16.19	75	A644	
1200		460	215T	E635	215TTFS6576	✓	20:1	\$1,473	E9	89.5	6.9	202	19.72	75	A206	
1200		230/460	215T	E474	215TTFS6881	✓	20:1	\$1,473	E9	89.5	13.8/6.9	202	19.72	75	A206	
1200		575	215T	E683	215TTFS6580		20:1	\$1,473	E9	89.5	5.5	202	19.72	75	A206	
7 1/2		3600	460	213T	E603	213TTTS6501	✓	1000:1	\$1,184	E9	91.7	8.9	200	17.19	75,N,NE	A206
	3600	460	213T	E396	213TTFS6501		2:1	\$1,303	E9	89.5	8.9	175	19.72	75	A206	
	3600	230/460	213T	E475	213TTTS6502	✓	1000:1	\$1,184	E9	91.7	17.8/8.9	200	17.19	75,N,NE	A206	
	3600	575	213T	E656	213TTTS6505	✓	1000:1	\$1,184	E9	91.7	7.1	200	17.19	75,N,NE	A206	
	1800	460	213T	E618	213TTFS6526	✓	20:1	\$1,124	E9	91.7	9.6	200	19.72	75	A206	
	1800	230/460	213T	E476	213TTFS6531	✓	20:1	\$1,124	E9	91.7	19.2/9.6	200	19.72	75	A206	
	1800	575	213T	E671	213TTFS6530	✓	20:1	\$1,124	E9	91.7	7.7	200	19.72	75	A206	
	1200	460	254T	E636	254TTFNA6576	✓	20:1	\$1,909	E9	91.0	9.9	326	23.52	75	A284	
	1200	230/460	254T	E477	254TTFNA6590	✓	20:1	\$1,909	E9	91.0	19.8/9.9	326	23.52	75	A284	
	1200	575	254T	E684	254TTFNA6578		20:1	\$1,909	E9	91.0	7.9	326	23.52	75	A284	
	10	3600	460	215T	E604	215TTFS6501	✓	2:1	\$1,382	E9	91.7	11.8	218	19.72	75	A206
		3600	230/460	215T	E478	215TTFS6807	✓	2:1	\$1,382	E9	91.7	23.6/11.8	218	19.72	75	A206
		3600	575	215T	E657	215TTFS6505		2:1	\$1,382	E9	91.7	9.5	218	19.72	75	A206
1800		460	215T	E619	215TTFS6526	✓	20:1	\$1,353	E9	91.7	12.5	225	19.72	75	A206	
1800		230/460	215T	E479	215TTFS6527	✓	20:1	\$1,353	E9	91.7	25.0/12.5	225	19.72	75	A206	
1800		575	215T	E672	215TTFS6530	✓	20:1	\$1,353	E9	91.7	10.0	225	19.72	75	A206	
1200		460	256T	E637	256TTFNA6576	✓	20:1	\$2,333	E9	91.0	13.1	405	25.27	75	A284	
1200		230/460	256T	E480	256TTFNA6596	✓	20:1	\$2,333	E9	91.0	26.2/13.1	405	25.27	75	A284	
1200		575	256T	E685	256TTFNA6578		20:1	\$2,333	E9	91.0	10.5	405	25.27	75	A284	

Catalog numbers (Cat No.) highlighted in bold blue have efficiency levels that meet EISA requirements

Blue shaded areas are Cast Iron Frames

* Requires nameplate modification

Continued on next page.

Blue Chip® Severe Duty / Automotive Duty NEMA Premium® XRI®

Totally Enclosed, Rigid Base, Three Phase

SEVERE DUTY

HP	RPM	VOLTS	FRAME	CAT. NO.	MODEL NO.	STOCK	CT SPEED RANGE*	LIST PRICE	MULT. SYMB.	NOM. EFF.	F.L. AMPS	WEIGHT	"C" DIM.	FOOT NOTES	C FACE KITS	
15	3600	460	254T	E605	254TTFNA6501	✓	2:1	\$1,852	E9	91.7	17.5	345	23.52	75	A284	
	3600	230/460	254T	E481	254TTFNA6515	✓	2:1	\$1,852	E9	91.7	35.0/17.5	345	23.52	75	A284	
	3600	575	254T	E658	254TTFNA6503		2:1	\$1,852	E9	91.7	14.2	345	23.52	75	A284	
	1800	460	254T	E620	254TTFNA6526	✓	20:1	\$1,738	E9	92.4	18.8	350	23.52	75	A284	
	1800	230/460	254T	E482	254TTFNA6529	✓	20:1	\$1,738	E9	92.4	37.6/18.8	350	23.52	75	A284	
	1800	575	254T	E673	254TTFNA6528	✓	20:1	\$1,738	E9	92.4	15.0	350	23.52	75	A284	
	1200	460	284T	E638	284TTFNA6576	✓	20:1	\$3,096	E9	91.7	20.4	479	26.34		A618	
	1200	230/460	284T	E483	284TTFNA6876	✓	20:1	\$3,096	E9	91.7	40.8/20.4	479	26.34		A618	
	1200	575	284T	E694	284TTFNA6580		20:1	\$3,096	E9	91.7	16.3	479	26.34		A618	
20	3600	460	256T	E606	256TTFNA6501	✓	2:1	\$2,294	E9	92.4	23.4	375	25.27	75	A284	
	3600	230/460	256T	E484	256TTFNA6523		2:1	\$2,294	E9	92.4	47.0/23.4	375	25.27	75	A284	
	3600	575	256T	E659	256TTFNA6503	✓	2:1	\$2,294	E9	92.4	18.7	375	25.27	75	A284	
	1800	460	256T	E621	256TTFNA6526	✓	20:1	\$2,166	E9	93.0	24.1	425	25.27	75	A284	
	1800	230/460	256T	E485	256TTFNA6529	✓	20:1	\$2,166	E9	93.0	48.2/24.1	425	25.27	75	A284	
	1800	575	256T	E674	256TTFNA6528	✓	20:1	\$2,166	E9	93.0	19.3	425	25.27	75	A284	
	1200	460	286T	E639	286TTFNA6576	✓	20:1	\$3,771	E9	91.7	26.8	550	27.84		A618	
	1200	230/460	286T	E486	286TTFNA6876		20:1	\$3,771	E9	91.7	53.5/26.8	550	27.84		A618	
	1200	575	286T	E695	286TTFNA6580		20:1	\$3,771	E9	91.7	21.4	550	27.84		A618	
25	3600	460	284TS	E607	284TSTFNA6501	✓	2:1	\$2,826	E9	93.6	28.1	481	24.97		A618	
	3600	575	284TS	E660	284TSTFNA6502		2:1	\$2,826	E9	93.6	22.5	481	24.97		A618	
	1800	460	284T	E622	284TTFNA6526	✓	20:1	\$2,579	E9	93.6	31.0	478	26.34		A618	
	1800	230/460	284T	E488	284TTFNA6837	✓	20:1	\$2,579	E9	93.6	62.0/31.0	478	26.34		A618	
	1800	575	284T	E675	284TTFNA6527	✓	20:1	\$2,579	E9	93.6	24.8	478	26.34		A618	
	1200	460	324T	E640	324TTFS6576	✓	20:1	\$4,571	E9	93.0	32.5	675	28.87		A214	
	1200	575	324T	E696	324TTFS6577		20:1	\$4,571	E9	93.0	26.0	675	28.87		A214	
	30	3600	460	286TS	E608	286TSTFNA6501	✓	2:1	\$3,300	E9	93.6	34.1	500	26.47		A618
	3600	230/460	286TS	E490	286TSTFNA6804	✓	2:1	\$3,300	E9	93.6	67.5/34.0	500	26.47		A618	
1800	460	286T	E623	286TTFNA6526	✓	20:1	\$2,999	E9	94.1	36.5	525	27.84		A618		
1800	230/460	286T	E491	286TTFNA6570	✓	20:1	\$2,999	E9	94.1	73.0/36.5	525	27.84		A618		
1800	575	286T	E676	286TTFNA6527	✓	20:1	\$2,999	E9	94.1	29.2	525	27.84		A618		
1200	460	326T	E641	326TTFS6576	✓	20:1	\$5,266	E9	93.0	38.5	725	30.37		A214		
1200	575	326T	E400	326TTFS6580		20:1	\$5,266	E9	93.0	31.0	725	30.37		A214		
40	3600	460	324TS	E609	324TSTFS6501	✓	2:1	\$4,353	E9	93.6	47.0	656	27.37		A214	
	3600	575	324TS	E662	324TSTFS6505		2:1	\$4,353	E9	93.6	37.5	656	27.37		A214	
	1800	460	324T	E624	324TTFS6526	✓	20:1@	\$3,983	E9	94.1	47.5	700	30.37		A214	
	1800	575	324T	E677	324TTFS6527	✓	20:1@	\$3,983	E9	94.1	38.0	700	30.37		A214	
	1200	460	364T	E642A	364TTFS16584	✓	20:1@	\$7,670	E9	94.1	50.0	882	31.50		A395	
	1200	575	364T	E401A	364TTFS16585		20:1@	\$7,670	E9	94.1	40.0	882	31.50		A395	
50	3600	460	326TS	E610	326TSTFS6501	✓	2:1	\$5,631	E9	93.6	58.0	725	28.87		A214	
	3600	575	326TS	E663	326TSTFS6502		2:1	\$5,631	E9	93.6	46.5	725	28.87		A214	
	1800	460	326T	E625	326TTFS6526	✓	20:1@	\$4,892	E9	94.5	60.0	775	31.87		A214	
	1800	460	326TS	E453	326TSTFS6536		20:1@	\$4,892	E9	94.5	60.0	775	28.87		A214	
	1800	575	326T	E678	326TTFS6527	✓	20:1@	\$4,892	E9	94.5	48.0	775	30.37		A214	
	1200	460	365T	E643A	365TTFS16591	✓	20:1@	\$8,623	E9	94.1	61.5	946	32.50		A395	
	1200	575	365T	E402A	365TTFS16592		20:1@	\$8,623	E9	94.1	49.0	946	32.50		A395	
	60	3600	460	364TS	E611	364TSTFS6501	✓	2:1	\$7,407	E9	94.5	67.0	954	29.38		A396
3600	575	364TS	E664	364TSTFS6505		2:1	\$7,407	E9	94.5	53.5	954	29.38		A396		
1800	460	364T	E626	364TTFS6536	✓	20:1@	\$7,018	E9	95.0	69.0	980	31.50		A395		
1800	460	364TS	E454	364TSTFS6526		20:1@	\$7,018	E9	95.0	69.0	980	29.38		A396		
1800	575	364T	E679	364TTFS6537	✓	20:1@	\$7,018	E9	95.0	55.0	980	31.50		A395		

Catalog numbers (Cat No.) highlighted in bold blue have efficiency levels that meet EISA requirements

Blue shaded areas are Cast Iron Frames

* Requires nameplate modification
@ Requires larger fan

Continued on next page.



Blue Chip® Severe Duty / Automotive Duty NEMA Premium® XRI®

Totally Enclosed, Rigid Base, Three Phase

SEVERE DUTY

HP	RPM	VOLTS	FRAME	CAT. NO.	MODEL NO.	STOCK	CT SPEED RANGE*	LIST PRICE	MULT. SYMB.	NOM. EFF.	F.L. AMPS	WEIGHT	"C" DIM.	FOOT NOTES	C FACE KITS	
60	1200	460	404T	E644	404TTFS6586	✓	20:1@	\$9,602	E9	94.5	72.0	1156	35.62		A223	
	1200	575	404T	E403	404TTFS6592		20:1@	\$9,602	E9	94.5	57.5	1156	35.62		A223	
75	3600	460	365TS	E612	365TSTFS6501	✓	2:1	\$9,302	E9	94.5	84.0	1002	30.38		A396	
	3600	575	365TS	E665	365TSTFS6502	✓	2:1	\$9,302	E9	94.5	67.0	1002	30.38		A396	
	1800	460	365T	E627	365TTFS6536	✓	20:1@	\$8,896	E9	95.4	86.0	1100	32.50		A395	
	1800	460	365TS	E455	365TSTFS6526	✓	20:1@	\$8,896	E9	95.4	86.0	1100	30.38		A396	
	1800	575	365T	E680	365TTFS6537	✓	20:1@	\$8,896	E9	95.4	69.0	1100	32.50		A395	
	1200	460	405T	E645	405TTFS6586	✓	20:1@	\$11,304	E9	94.5	90.0	1280	37.12		A223	
	1200	575	405T	E404	405TTFS6587		20:1@	\$11,304	E9	94.5	71.5	1280	37.12		A223	
	100	3600	460	405TS	E613	405TSTFS6501	✓	2:1	\$12,465	E9	95.0	108	1295	34.12		A226
3600		575	405TS	E493	405TSTFS6502		2:1	\$12,465	E9	95.0	87.0	1295	34.12		A226	
1800		460	405T	E628	405TTFS6536	✓	20:1@	\$10,991	E9	95.4	113	1330	37.12		A223	
1800		460	405TS	E456	405TSTFS6526	✓	20:1@	\$10,991	E9	95.4	113	1330	34.12		A226	
1800		575	405T	E681	405TTFS6538	✓	20:1@	\$10,991	E9	95.4	90.5	1330	37.12		A223	
1200		460	444T	E327	444TTFN16577		20:1@	\$16,975	E9	95.0	124	1970	41.34		A620	
1200		460	444T	E646A	444TTFN16581	✓	20:1@	\$16,975	E9	95.0	124	1806	43.35		A620	
1200		575	444T	E405A	444TTFS16582		20:1@	\$16,975	E9	95.0	94.5	1690	41.25		A229	
125		3600	460	444TS	E614	444TSTFS6501	✓	2:1	\$16,295	E9	95.4	136	1725	37.50		A232
		3600	575	444TS	E494	444TSTFS6505		2:1	\$16,295	E9	95.4	109	1725	37.50		A232
	1800	460	444T	E629	444TTFS6536	✓	20:1@	\$14,469	E9	95.4	141	1725	41.25		A229	
	1800	460	444TS	E457	444TSTFS6526	✓	20:1@	\$14,469	E9	95.4	141	1725	37.50		A232	
	1800	575	444T	E697	444TTFS6540	✓	20:1@	\$14,469	E9	95.4	113	1725	41.25		A229	
	1200	460	445T	E647	445TTFN6586	✓	20:1@	\$18,975	E9	95.0	155	2000	43.26		A620	
	1200	575	445T	E406	445TTFN6590		20:1@	\$18,975	E9	95.0	124	2000	43.26		A620	
	150	3600	460	445TS	E615	445TSTFN6501	✓	2:1	\$19,574	E9	95.8	165	2187	39.44		A621
3600		575	445TS	E495	445TSTFN6502		2:1	\$19,574	E9	95.8	132	2187	39.44		A621	
1800		460	445T	E630	445TTFN6536	✓	20:1@	\$16,822	E9	95.8	172	2070	43.26		A620	
1800		460	445TS	E458	445TSTFN6526	✓	20:1@	\$16,822	E9	95.8	172	2070	39.44		A621	
1800		575	445T	E682	445TTFN6537	✓	20:1@	\$16,822	E9	95.8	138	2070	43.26		A620	
1200		460	445T	E448	445TTFN6587	✓	20:1@	\$21,229	E9	95.8	180	2500	43.26	H, RB	N/A	
1200		575	445T	E407	445TTFN6591		20:1@	\$21,229	E9	95.8	145	2500	43.26	RB	N/A	
200		3600	460	445TS	E449	445TSTFN6505	✓	2:1	\$24,762	E9	95.8	222	2300	39.44	H	A621
	3600	575	445TS	E496	445TSTFN6506		2:1	\$24,762	E9	95.8	178	2300	39.44		A621	
	1800	460	445T	E631	445TTFN6538	✓	20:1@	\$20,459	E9	96.2	226	2437	43.26	RB	N/A	
	1800	460	445TS	E459	445TSTFN6528	✓	20:1@	\$20,459	E9	96.2	226	2437	39.44	H	A621	
	1800	460	447/9T	E770	449TTFS6530	✓	20:1@	\$23,528	E9	96.5	225	2700	51.69	H	A623	
	1800	460	447/9T	E854	449TTFS6540	✓	20:1@	\$23,528	E9	96.5	225	2700	51.69	H, RB	N/A	
	1800	575	447/9T	E856	449TTFS6564	✓	20:1@	\$23,528	E9	96.5	180	2700	51.69	H, RB	N/A	
	1200	460	447/9T	E773	449TTFS6578	✓	20:1@	\$25,988	E9	95.8	240	2927	51.69	H	A623	
	1200	460	447/9T	E687	449TTFS6588	✓	20:1@	\$25,988	E9	95.8	240	2927	51.69	H, RB	N/A	
	1200	575	447/9T	E408	449TTFS6582		20:1@	\$25,988	E9	95.8	192	2927	51.69	H, RB	N/A	
250	3600	460	447/9TS	E699	449TSTFS6503	✓	2:1	\$31,230	E9	95.8	275	2700	47.88	H, NE	A624	
	1800	460	445T	E450	445TTFN6540		20:1@	\$25,668	E9	95.8	285	2450	43.26	H, NE, RB	N/A	
	1800	460	447/9T	E771	449TTFS6528	✓	20:1@	\$29,517	E9	96.5	285	2830	51.69	H, NE	A623	
	1800	460	447/9T	E690	449TTFS6538	✓	20:1@	\$29,517	E9	96.5	285	2830	51.69	H, NE, RB	N/A	
	1200	460	L447/9T	E774	449TTFS6577		20:1@	\$29,874	E9	95.8	300	3415	51.69	H, NE	A623	
	1200	460	L447/9T	E688	449TTFS6587		20:1@	\$29,874	E9	95.8	300	3415	51.69	H, NE, RB	N/A	

Catalog numbers (Cat No.) highlighted in bold blue have efficiency levels that meet EISA requirements

Blue shaded areas are Cast Iron Frames

* Requires nameplate modification
@ Requires larger fan

Continued on next page.

Blue Chip® Severe Duty / Automotive Duty NEMA Premium® XRI®

Totally Enclosed, Rigid Base, Three Phase

HP	RPM	VOLTS	FRAME	CAT. NO.	MODEL NO.	STOCK	CT SPEED RANGE*	LIST PRICE	MULT. SYMB.	NOM. EFF.	F.L. AMPS	WEIGHT	"C" DIM.	FOOT NOTES	C FACE KITS
300	3600	460	447/9TS	E698	449TSTFS6502	√	2:1	\$40,479	E9	96.2	330	2700	47.88	H,NE	A626
	1800	460	447/9T	E691	449TTFS6537	√	20:1@	\$32,767	E9	96.5	339	3211	51.69	H,NE,RB	N/A
	1800	460	447/9T	E772	449TTFS6527		20:1@	\$32,767	E9	96.5	339	3211	51.69	H,NE	A623
	1800	575	447/9T	E345	449TTFS16534		20:1@	\$32,767	E9	96.5	271	3211	51.69	H,NE,RB	N/A
350	3600	460	447/9TS	E769	449TSTFS6501	√	2:1	\$46,420	E9	95.8	380	3064	47.88	H,NE	A624
	1800	460	447/9T	E692	449TTFS6536	√	20:1@	\$38,274	E9	96.2	395	3350	51.69	H,NE,RB	N/A
400	3600	460	5011S	E369	---		N/A	\$55,099	S6	95.8	432	5500	67.19	NE,90	N/A
	1800	460	L447/9T	E776	449TTFS16553		2:1	\$39,295	E9	96.2	448	3800	56.71	H,NE,79	N/A
	1200	460	5011LS	E362	---		N/A	\$68,918	S6	95.8	468	5500	67.19	NE,77,79,90	N/A
450	1800	460	L447/9T	E777	---		N/A	\$40,177	E9	96.5	515	3800	56.71	H,NE,79	N/A
	1200	460	5013LS	E363	5013LSTFS6595		N/A	\$91,917	S6	96.2	525	7200	67.19	A,NE,77,79,90	N/A
500	1800	460	5011LS	E364	5011LSTFS16031		N/A	\$63,352	S6	96.2	555	5500	67.19	NE,77,79,90	N/A
	1200	460	5013LS	E365	---		N/A	\$93,219	S6	96.2	580	7200	76.19	NE,78,79,90	N/A
600	1800	460	5011LS	E366	5011LSTFS16033		N/A	\$75,063	S6	96.2	655	5500	67.19	A,NE,77,79,90	N/A

Catalog numbers (Cat No.) highlighted in bold blue have efficiency levels that meet EISA requirements

Blue shaded areas are Cast Iron Frames

* Requires nameplate modification
@ Requires larger fan

Blue Chip® Severe Duty / Automotive Duty NEMA Premium® XRI® IEEE-841 Totally Enclosed, Rigid Base, Three Phase

Applications:

For extreme applications in the process industries such as chemical plants, pulp and paper mills, refineries, above-ground mines, food processing, foundries, and other severe duty environments where long life and ultra-high efficiency are required. Guaranteed efficiencies offer an eXtra Return on your Investment when using these premium efficiency motors on high cycle or long run time applications.



Features:

- Meets or exceeds NEMA Premium® efficiencies, except where noted
- NEMA Premium® models are in compliance with EISA2007
- Meets IEEE-841 standard for severe duty applications
- Blue Chip® quality, 100% cast iron construction for rigidity and reduced vibration
- Inpro/Seal® VBX® bearing isolators on drive end shaft extension TENV and on both ends of TEFC
- Provisions to add stub shaft for an encoder (182T-449T, TEFC only)
- Internal and external epoxy paint
- MAX GUARD® Class F insulation system
- Constant Torque speed range is listed in CT SPEED RANGE column
- 1.15 Service Factor on sinewave, 1.0 Service Factor on IGBT power
- Bearing caps (254T and larger)
- Precision balanced to .08"/sec
- Extended grease tubes, regreasable in service
- Brass drain and breather
- Meets General Motors GM 7E-TA Automotive Duty Specification
- Meets IEEE45 USCG Marine Duty, API RPI4F for offshore platforms, IP56
- Meets NEMA MG1 - 1.26.6 Waterproof specification
- Hazardous Duty™ Division 2 CSA certification nameplate
- Division 2 / Zone 2 Class I (gases), Groups A, B, C, D
- Meets temperature code T2B
- Actual test and vibration data supplied with each motor
- Ball bearings (except as noted)
- UL Recognized (through 449T) and CSA Certified and CE Marked
- Five year warranty

Models through 40 HP are capable of modification as follows (contact factory to confirm):

- 1.25 Service Factor (sinewave only)
- 50Hz at same HP, 1.0 Service Factor (sinewave only)
- Any nameplate changes are subject to modification charges (see MOD Central section)
- Contact Marathon Electric for optional nameplate markings on 50 HP and larger



Suitable for use on VFD per guidelines on page 17.

HP	RPM	VOLTS	FRAME	CAT. NO.	MODEL NO.	STOCK	CT SPEED RANGE*	LIST PRICE	MULT. SYMB.	NOM. EFF.	F.L. AMPS	WEIGHT	"C" DIM.	FOOT NOTES	C FACE KITS
1	1800	460	143T	W501	143THTN9026	√	1000:1	\$661	E9	85.5	1.5	55	10.43	75,76,N,NE	A181
	1800	575	143T	W502	143THTN19033		1000:1	\$661	E9	85.5	1.2	55	10.43	75,76,N,NE	A181
	1200	460	145T	W503	145THTN9076		1000:1	\$832	E9	80.0	1.65	60	11.43	75,76,N,NE	A262
	1200	575	145T	W638	145THTN19079		1000:1	\$832	E9	80.0	1.3	60	11.43	75,76,N,NE	A262
	900	460	182T	W504	182THFS19101		20:1	\$1,461	E9	74.0	2.2	81	15.19	75,NE	A182
1 1/2	3600	460	143T	W505	143THTN9001		1000:1	\$827	E9	86.5	2.0	58	10.43	75,76,N,NE	A181
	3600	575	143T	W506	143THTN9005		1000:1	\$827	E9	86.5	1.6	58	10.43	75,76,N,NE	A181
	1800	460	145T	W507	145THTN9026	√	1000:1	\$716	E9	84.0	2.2	65	11.43	75,76,N,NE	A262
	1800	575	145T	W508	145THTN19045		1000:1	\$716	E9	84.0	1.75	65	11.43	75,76,N,NE	A262
	1200	460	182T	W509	182THTS9076		1000:1	\$1,065	E9	87.5	2.2	100	12.71	75,N,NE	A182
2	3600	460	145T	W511	145THTN9001		1000:1	\$867	E9	85.5	2.5	68	11.43	75,76,N,NE	A262
	3600	575	145T	W512	145THTN19002		1000:1	\$867	E9	85.5	2.0	68	11.43	75,76,N,NE	A262
	1800	460	145T	W513	145THTN9027	√	1000:1	\$787	E9	85.5	3.0	68	11.43	75,76,N,NE	A262
	1800	575	145T	W514	145THTN19033		1000:1	\$787	E9	85.5	2.4	68	11.43	75,76,N,NE	A262
	1200	460	184T	W515	184THTS9076		1000:1	\$1,315	E9	88.5	3.0	112	13.71	75,N,NE	A182

Catalog numbers (Cat No.) highlighted in bold blue have efficiency levels that meet EISA requirements

Blue shaded areas are Cast Iron Frames

* Requires nameplate modification

Continued on next page.

Blue Chip® Severe Duty / Automotive Duty NEMA Premium® XRI® IEEE-841 Totally Enclosed, Rigid Base, Three Phase

SEVERE DUTY

HP	RPM	VOLTS	FRAME	CAT. NO.	MODEL NO.	STOCK	CT SPEED RANGE*	LIST PRICE	MULT. SYMB.	NOM. EFF.	F.L. AMPS	WEIGHT	"C" DIM.	FOOT NOTES	C FACE KITS
3	3600	460	182T	W517	182THTS9001		1000:1	\$1,191	E9	87.5	3.8	105	12.71	75,N,NE	A182
	1800	460	182T	W519	182THTS9026	✓	1000:1	\$1,068	E9	90.2	4.0	100	12.71	75,N,NE	A182
	1800	575	182T	W520	182THTS19033		1000:1	\$1,068	E9	90.2	3.2	100	12.71	75,N,NE	A182
	1200	460	213T	W521	213THFS9076	✓	20:1	\$1,620	E9	89.5	4.4	176	18.22	75	A183
	900	460	215T	W522	215THFS9101		20:1	\$2,426	E9	86.5	5.0	180	19.72	75,NE	A183
5	3600	460	184T	W523	184THFS9001	✓	2:1	\$1,323	E9	89.5	5.9	142	16.19	75	A182
	3600	575	184T	W524	184THFS19006		2:1	\$1,323	E9	89.5	4.7	142	16.19	75	A182
	1800	460	184T	W525	184THFS9026	✓	20:1	\$1,238	E9	90.2	6.2	130	16.19	75	A182
	1800	575	184T	W526	184THFS9030	✓	20:1	\$1,238	E9	90.2	5.0	130	16.19	75	A182
	1200	460	215T	W527	215THFS9076	✓	20:1	\$1,988	E9	89.5	6.9	202	19.72	75	A183
7 1/2	1200	575	215T	W528	215THFS19077		20:1	\$1,988	E9	89.5	5.5	202	19.72	75	A183
	900	460	254T	W529	254THFNA9101		10:1	\$3,162	E9	88.5	7.5	375	23.52	75,NE	A184
	3600	460	213T	W530	213THTS9001	✓	2:1	\$1,598	E9	91.7	8.9	200	17.18	75,N	A183
	3600	575	213T	W531	213THTS19005		2:1	\$1,598	E9	91.7	7.1	200	17.18	75,N	A183
	1800	460	213T	W532	213THFS9026	✓	20:1	\$1,517	E9	91.7	9.6	200	19.73	75	A183
10	1800	575	213T	W533	213THFS9030	✓	20:1	\$1,517	E9	91.7	7.7	200	19.72	75	A183
	1200	460	254T	W534	254THFNA9076	✓	20:1	\$2,287	E9	91.0	9.9	326	23.52	75	A184
	900	460	256T	W536	256THFNA9101		20:1	\$3,921	E9	88.5	11.0	425	25.27	75,NE	A184
	3600	460	215T	W537	215THFS9001	✓	2:1	\$1,866	E9	91.7	11.9	218	19.72	75	A183
	3600	575	215T	W538	215THFS19006		2:1	\$1,866	E9	91.7	9.5	218	19.72	75	A183
15	1800	460	215T	W539	215THFS9026	✓	20:1	\$1,827	E9	91.7	12.5	225	19.72	75	A183
	1800	575	215T	W540	215THFS19033	✓	20:1	\$1,827	E9	91.7	10.0	225	19.73	75	A183
	1200	460	256T	W541	256THFNA9076		20:1	\$2,915	E9	91.0	13.1	405	25.27	75	A184
	1200	575	256T	W542	256THFNA19081		20:1	\$2,915	E9	91.0	10.5	405	25.27	75	A184
	900	460	284T	W543	284THFNA19102		20:1	\$4,767	E9	90.2	16.0	550	27.88	NE	A186
20	3600	460	254T	W544	254THFNA9001	✓	20:1	\$2,314	E9	91.7	17.5	345	23.52		A184
	1800	460	254T	W546	254THFNA9026	✓	20:1	\$2,173	E9	92.4	18.8	350	23.52		A184
	1800	575	254T	W547	254THFNA9030	✓	20:1	\$2,173	E9	92.4	15.1	350	23.52		A184
	1200	460	284T	W548	284THFNA9076	✓	20:1	\$3,870	E9	91.7	20.4	479	27.88		A186
	1200	575	284T	W549	284THFNA16585		20:1	\$3,870	E9	91.7	16.3	479	26.34		A186
25	900	460	286T	W550	286THFNA19101		20:1	\$5,980	E9	90.2	22.0	575	27.84	NE	A186
	3600	460	256T	W551	256THFNA9001	✓	2:1	\$2,868	E9	92.4	23.4	375	25.27	75	A184
	1800	460	256T	W553	256THFNA9026	✓	20:1	\$2,708	E9	93.0	24.1	425	25.27	75	A184
	1800	575	256T	W554	256THFNA19033	✓	20:1	\$2,708	E9	93.0	19.3	425	25.27	75	A184
	1200	460	286T	W555	286THFNA9076		20:1	\$4,714	E9	91.7	26.8	550	27.84		A186
30	1200	575	286T	W556	286THFNA19077		20:1	\$4,714	E9	91.7	21.4	550	27.84		A186
	3600	460	284TS	W558	284TSHFNA9001	✓	2:1	\$3,533	E9	93.6	28.1	481	24.97		A186
	3600	575	284TS	W559	284TSHFNA9005		2:1	\$3,533	E9	93.6	22.4	481	24.97		A186
	1800	460	284T	W560	284THFNA9026	✓	20:1	\$3,223	E9	93.6	31.0	478	26.44		A186
	1800	575	284T	W561	284THFNA19033		20:1	\$3,223	E9	93.6	24.8	478	26.34		A186
40	1200	460	324T	W562	324THFS9076		20:1	\$5,715	E9	93.0	32.5	675	28.87		A187
	1200	575	324T	W563	324THFS9080		20:1	\$5,715	E9	93.0	26.0	675	28.87		A187
	3600	460	286TS	W565	286TSHFNA9001	✓	2:1	\$4,126	E9	93.6	33.8	500	26.44		A186
	1800	460	286T	W567	286THFNA9026	✓	20:1	\$3,749	E9	94.1	36.5	525	27.84		A186
	1800	575	286T	W568	286THFNA19033		20:1	\$3,749	E9	94.1	29.2	525	27.84		A186
50	1200	460	326T	W569	326THFS9076	✓	20:1@	\$6,582	E9	93.0	38.5	725	30.37		A187
	1200	575	326T	W643	326THFS19078		20:1@	\$6,582	E9	93.0	31.0	725	30.37		A187
	3600	460	324TS	W571	324TSHFS9001	✓	2:1	\$5,441	E9	93.6	47.0	656	27.37		A187
	1800	460	324T	W573	324THFS9026	✓	20:1@	\$4,978	E9	94.1	47.5	700	28.87		A187
	1800	575	324T	W574	324THFS19033		20:1@	\$4,978	E9	94.1	38.0	700	30.37		A187
60	1200	460	364T	W575A	364THFS19087		20:1@	\$8,207	E9	94.1	50.0	950	31.50		A188
	1200	575	364T	W639	364THFS19077		20:1@	\$8,207	E9	94.1	40.0	950	31.50		A188
	900	460	365T	W576	365THFS19101		20:1@	\$11,701	E9	91.7	53.0	975	32.50	NE	A188

Catalog numbers (Cat No.) highlighted in bold blue have efficiency levels that meet EISA requirements

Blue shaded areas are Cast Iron Frames

* Requires nameplate modification

@ Requires larger fan

Continued on next page.



Blue Chip® Severe Duty / Automotive Duty

NEMA Premium® XRI® IEEE-841

Totally Enclosed, Rigid Base, Three Phase

HP	RPM	VOLTS	FRAME	CAT. NO.	MODEL NO.	STOCK	CT SPEED RANGE*	LIST PRICE	MULT. SYMB.	NOM. EFF.	F.L. AMPS	WEIGHT	"C" DIM.	FOOT NOTES	C FACE KITS
50	3600	460	326TS	W577	326TSHFS9001		2:1	\$7,038	E9	93.6	58.0	725	28.87		A187
	3600	575	326TS	W578	326TSHFS9005		2:1	\$7,038	E9	93.6	46.5	725	28.87		A187
	1800	460	326T	W580	326THFS9026	✓	2:1	\$6,115	E9	94.5	60.0	775	30.37		A187
	1800	460	326TS	W579	326TSHFS9036		2:1	\$6,115	E9	94.5	60.0	775	28.87		A187
	1800	575	326T	W581	326THFS19033		2:1	\$6,115	E9	94.5	48.0	775	30.37		A187
	1200	460	365T	W582A	365THFS19086	✓	20:1@	\$10,066	E9	94.5	61.5	942	32.50		A188
	1200	575	365T	W640	365THFS19077		20:1@	\$10,166	E9	94.5	49.0	983	31.50		A188
	900	460	404T	W583	404THFS9101		20:1@	\$13,166	E9	93.6	66.0	1264	35.62	NE	A190
	60	3600	460	364TS	W584	364TSHFS9001	✓	2:1	\$8,519	E9	94.5	67.0	925	29.38	
1800	460	364T	W587	364THFS9036	✓	20:1@	\$8,070	E9	95.0	69.0	1000	31.50		A188	
1800	460	364TS	W586	364TSHFS9026		20:1@	\$8,070	E9	95.0	69.0	1000	29.38		A189	
1800	575	364T	W588	364THFS19033		20:1@	\$8,070	E9	95.0	55.0	1000	31.50		A188	
1200	460	404T	W589	404THFS9086		20:1@	\$11,043	E9	94.5	72.0	1156	35.62		A190	
900	460	405T	W590	405THFS19101		20:1@	\$14,773	E9	93.6	80.0	1350	37.12	NE	A190	
75	3600	460	365TS	W591	365TSHFS9001	✓	2:1	\$10,697	E9	94.5	84.0	1002	30.38		A189
	3600	575	365TS	W592	365TSHFS19002		2:1	\$10,697	E9	94.5	67.0	1002	30.38		A189
	1800	460	365T	W594	365THFS9036	✓	20:1@	\$10,231	E9	95.4	86.0	1100	32.50		A188
	1800	460	365TS	W593A	365TSHFS19034		20:1@	\$10,231	E9	95.4	86.0	1100	30.38		A189
	1800	575	365T	W595	365THFS9044	✓	20:1@	\$10,231	E9	95.4	69.0	1100	32.50		A188
	1200	460	405T	W596	405THFS9086		20:1@	\$12,998	E9	95.0	90.0	1280	37.12		A190
	900	460	444T	W597	444THFS9101		20:1@	\$19,643	E9	93.6	100	1734	41.25	NE	A192
100	3600	460	405TS	W598	405TSHFS9001	✓	2:1	\$14,334	E9	95.0	108	1295	34.12		A191
	1800	460	405T	W600	405THFS9036	✓	20:1@	\$12,640	E9	95.4	113	1330	37.12		A190
	1800	460	405TS	W599	405TSHFS9026		20:1@	\$12,640	E9	95.4	113	1330	34.12		A191
	1800	575	405T	W601	405THFS9040	✓	20:1@	\$12,640	E9	95.4	90.0	1330	37.12		A190
	1200	460	444T	W636	444THFN19081		20:1@	\$19,168	E9	95.0	124	2100	41.25		A192
	900	460	445T	W603	445THFN9106		20:1@	\$24,072	E9	94.1	142	2350	43.19	NE	A192
	125	3600	460	444TS	W604A	444TSHFN19002		2:1	\$18,740	E9	95.0	142	1682	39.64	
1800		460	444T	W606	444THFS9036	✓	20:1@	\$16,640	E9	95.4	141	1725	41.25		A192
1800		575	444T	W607	444THFS9040	✓	20:1@	\$16,640	E9	95.4	113	1725	41.25		A192
1200		460	445T	W608	445THFN9086		20:1@	\$21,820	E9	95.0	155	2000	43.19		A192
900		460	445T	W609	445THFN9102		20:1@	\$24,724	E9	94.5	172	2515	43.19	NE	A194
150	3600	460	445TS	W610	445TSHFN9001		2:1	\$22,511	E9	95.8	165	2187	39.37		A195
	1800	575	445TS	W611	445TSHFN9026	✓	20:1@	\$19,345	E9	95.8	172	2070	39.37		A194
	1800	460	445T	W612	445THFN9036	✓	20:1@	\$19,345	E9	95.8	172	2070	43.19		A194
	1800	575	445T	W641	445THFN19033		20:1@	\$19,345	E9	95.8	138	2070	43.19	RB	A194
	1800	575	445T	W613	445THFN9037		20:1@	\$19,345	E9	95.8	138	2070	43.19		A194
	1200	460	445T	W614	445THFN9087		20:1@	\$24,415	E9	95.8	181	2500	43.19	H, RB	A194
	900	460	L447/9T	W615	449THFS9101		20:1@	\$31,445	E9	95.4	205	3150	51.88	NE	N/A
	200	3600	460	445TS	W616	445TSHFN9005		2:1@	\$28,477	E9	95.8	223	2300	39.37	H, SL
1800	460	445T	W618	445THFN9038		20:1@	\$23,528	E9	96.2	226	2437	43.19	RB	A194	
	460	445TS	W617	445TSHFN9028		20:1@	\$23,528	E9	96.2	226	2700	39.37		A195	
	460	447/9T	W619	449THFS9030		20:1@	\$27,056	E9	96.5	225	2700	51.69		N/A	
	575	445T	W642	445THFN19034	✓	20:1@	\$27,056	E9	96.2	181	2437	43.19		A194	
	1200	460	447/9T	W621	449THFS19092		20:1@	\$29,886	E9	95.8	225	2927	51.84	RB	N/A
	1200	460	447/9T	W622	449THFS9088		20:1@	\$29,886	E9	95.8	240	2927	51.69	RB	N/A
	1200	575	447/449T	W630	449THFS19079		20:1@	\$29,886	E9	95.8	192	2927	51.69	RB	N/A
	250	3600	460	447/9TS	W624	449TSHFS9003		2:1	\$35,914	E9	96.5	2700	2700	47.94	
1800	460	447/9T	W626	449THFS9028		20:1@	\$33,946	E9	96.5	2830	2830	51.69		N/A	
300	1800	460	447/9T	W632	449THFS9027		20:1@	\$34,625	E9	96.5	3211	3211	51.84		N/A
350	3600	460	447/9TS	W634	449TSHFS9001		2:1	\$53,384	E9	96.2	3064	3064	47.94	SL	N/A
	1800	460	447/9T	W635	449THFS9036		2:1	\$44,015	E9	96.2	3350	3350	51.84	RB, SL	N/A

Catalog numbers (Cat No.) highlighted in bold blue have efficiency levels that meet EISA requirements

Blue shaded areas are Cast Iron Frames

* Requires nameplate modification
@ Requires larger fan

Hazardous Duty™ Division 1 Explosion Proof Class I Only, Groups C (as noted), D

Blue Chip®, EPart Efficiency, Three Phase

Features:

- 10:1 Variable torque, 2:1 Constant torque
- 1.15 Service Factor
- Class F insulation
- Meets temperature code T2A
- All Cast iron construction
- Shaft slinger
- External surface treated with epoxy paint
- Nameplated 60/50 Hz, 190/380 Volts, at next lower HP
- See modification section for addition of C-Face kits (254T-445T)
- Ball bearings (except as noted)
- UL Listed File No. E12044
- CSA Certified File No. LR47504
- Two year warranty



EXPLOSION PROOF

Rigid Base

HP	RPM	VOLTS	FRAME	GROUP C	CAT. NO.	MODEL NO.	STOCK	LIST PRICE	MULT. SYMB.	NOM. EFF.	F.L. AMPS	WEIGHT	"C" DIM.	FOOT NOTES
3	1200	230/460	213T	N	U940	213TTGS1076	✓	\$1,092	E7	87.5	9.0/4.5	236	19.66	d,25
15	1800	230/460	254T	Y	U951	254TTGN1026	✓	\$1,814	E7	91.0	39.0/19.5	361	23.52	d
75	1200	230/460	405T	Y	U973	405TTGS1086	✓	\$11,865	E7	93.6	185/92.5	1384	37.12	d
100	1800	230/460	405T	Y	U097	405TTGS4046	✓	\$12,412	E7	94.5	228/114	1355	37.12	d

Blue shaded areas are Cast Iron Frames



Hazardous Duty™ Division 1 Explosion Proof Class I and II, Groups D, F & G

Blue Chip® Severe Duty, NEMA Premium Efficiency, Three Phase

Features:

- 10:1 Variable torque, see Inverter Duty column for constant torque
- 1.15 Service Factor
- Normally closed thermostats (must be connected to control circuit)
- Meets temperature code T3B
- All cast iron construction
- External surface treated with epoxy paint
- Nameplated 60/50 hertz, 190/380 Volts, at next lower horsepower as noted
- UL Listed
- CSA Certified File No. LR47504
- Two year warranty



EXPLOSION PROOF

IP54

C-Face Footed (Rigid Base)

HP	RPM	VOLTS	FRAME	CAT. NO.	MODEL NO.	STOCK	CT SPEED RANGE*	LIST PRICE	MULT. SYMB.	NOM. EFF.	F.L. AMPS	WEIGHT	"C" DIM.	FOOT NOTES
1	1800	208-230/460	143TC	C361A	143TTGN6551	√	10:1	\$886	E7	85.5	3.0-3.0/1.5	72	15.23	68,80
1 1/2	1800	208-230/460	145TC	C362A	145TTGN6536	√	10:1	\$938	E7	86.5	4.7-4.6/2.3	88	15.23	68,80
2	1800	208-230/460	145TC	C363A	145TTGN6549	√	10:1	\$986	E7	86.5	6.2-6.0/3.0	90	15.23	68,80
3	1800	208-230/460	182TC	C364A	182TTGN6569	√	10:1	\$1,146	E7	89.5	8.4-8.0/4.0	154	16.62	68
	1800	575	182TC	C368A	182TTGN6536		10:1	\$1,146	E7	89.5	3.2	158	16.62	
5	1800	208-230/460	184TC	C365A	184TTGN6575	√	10:1	\$1,249	E7	89.5	13.8-12.4/6.2	168	18.62	68
	1800	575	184TC	C369A	184TTGN6537		10:1	\$1,249	E7	89.5	5.0	167	18.62	
7 1/2	1800	208-230/460	213TC	C366A	213TTGN6528	√	10:1	\$1,698	E7	91.7	20.8-19.2/9.6	255	20.45	68
	1800	575	213TC	C370A	213TTGN6536		10:1	\$1,698	E7	91.7	7.7	275	20.45	
10	1800	208-230/460	215TC	C367A	215TTGN6528	√	2:1	\$1,953	E7	91.7	27.0-25.0/12.5	228	23.45	68
	1800	575	215TC	C371A	215TTGN16534		2:1	\$1,953	E7	91.7	10.0	201	23.45	

Catalog numbers (Cat No.) highlighted in bold blue have efficiency levels that meet EISA requirements

Blue shaded areas are Cast Iron Frames

Hazardous Duty™ Division 1 Explosion Proof Class I and II, Groups C, D, E (as noted), F & G Steel Frame, Standard and NEMA Premium Efficiencies, Three Phase

Features:

- 1.0 Service Factor (except as noted)
- Meets temperature code T3B
- Explosion proof conduit box included, shipped loose
- UL Listed File No. E12044
- CSA Certified File No. LR47504
- K717 is rated for Class I Group D, Class II Groups F&G only
- Automatic Overload (except as noted)



EXPLOSION PROOF

Rigid Base

HP	RPM	VOLTS	FRAME	GROUP E	CAT. NO.	MODEL NO.	STOCK	LIST PRICE	MULT. SYMB.	NOM. EFF.	F.L. AMPS	WEIGHT	"C" DIM.	FOOT NOTES
1/4	1800	230/460	48	N	K717	5K32GNB249	✓	\$578	F1	62.5	1.2/0.6	19	9.68	
	1800	208-230/460	56	N	G646	56T17E5308	✓	\$545	F1	71.0	1.1-1.1/55	25	11.97	N
	1800	575	56	N	G664	56T17E5314		\$545	F1	71.0	0.43	25	11.97	N
1/3	1800	208-230/460	56	N	G647	56T17E5309	✓	\$580	F1	74.0	1.3-1.2/60	25	11.97	N
	1800	575	56	N	G665	56T17E5315		\$580	F1	74.0	0.5	25	11.97	N
	1200	230/460	56	N	K2101	5K49FN6381	✓	\$783	F1	62.0	2.2/1.1	29	13.44	
1/2	3600	208-230/460	56	N	G648	56T34G5303		\$533	F1	66.5	2.1-2.4/1.2	30	13.44	
	1800	208-230/460	56	N	K2103	5K49JN4560	✓	\$613	F1	68.0	2.2-2.4/1.2	29	13.94	d
	1800	208-230/460	56	N	G649	56T17G5312	✓	\$613	F1	68.0	2.3-2.4/1.2	28	13.94	
	1800	200	56	N	K2102	5K49JN4582	✓	\$701	F1	68.0	2.75	29	13.94	
	1800	575	56	N	G666	56T17G5321	✓	\$613	F1	68.0	1.0	28	13.94	
	1200	230/460	56	N	K2104	5K49HN6385	✓	\$825	F1	68.0	2.7/1.35	34	13.44	
3/4	3600	208-230/460	56	N	G660	56T34G5304		\$585	F1	74.0	3.0-3.2/1.6	30	13.44	
	1800	208-230/460	56	N	G661	56T17G5313	✓	\$647	F1	75.5	2.9-3.0/1.5	30	13.94	
	1800	200	56	N	K2105	5K49JN4574	✓	\$747	F1	75.5	3.45	31	13.94	
	1800	575	56	N	G667	56T17G5322	✓	\$647	F1	75.5	1.2	29	13.94	
	1200	208-230/460	143T	N	K2107	5K49MN8349	✓	\$883	F1	74.0	3.2-3.2/1.6	42	14.00	
	1200	208-230/460	56	N	K2116	5K49MN6382	✓	\$878	F1	74.0	3.2-3.2/1.6	42	13.94	
1	3600	208-230/460	56	N	K2108	5K49HN2507	✓	\$621	F1	74.0	3.0-3.2/1.6	30	13.44	d
	3600	208-230/460	56	N	G662	56T34G5305	✓	\$621	F1	74.0	3.9-3.6/1.8	28	13.44	
	1800	208-230/460	56	N	G663	56T17G5314	✓	\$653	F1	77.0	3.5-3.6/1.8	31	13.94	
	1800	208-230/460	143T	Y	I502	143TTGR16026	✓	\$1,016	E7	85.5	3.3-3.3/1.65	48	16.00	TS
	1800	575	56	N	G668	56T17G5323	✓	\$653	F1	77.0	1.45	31	13.94	
	1800	575	143T	Y	I503	143TTGR16030		\$1,016	E7	85.5	1.3	48	16.00	A,TS
	1200	230/460	56H	N	K2110	5K49TN6383	✓	\$921	F1	77.0	3.4/1.7	47	15.50	
	1200	208-230/460	145T	N	K2202	5KE49TN8356	✓	\$1,052	E7	80.0	3.6-3.4/1.7	49	15.50	d,TS
	1200	208-230/460	145T	Y	I504	145TTGR16076	✓	\$1,230	E7	82.5	3.8-3.8/1.9	58	16.50	TS
	1200	575	145T	Y	I505	145TTGR16080		\$1,230	E7	82.5	1.5	58	16.50	TS
1 1/2	3600	208-230/460	143T	Y	I506	143TTGR16001	✓	\$941	E7	84.0	4.0/2.0	38	14.50	TS
	3600	575	143T	Y	I507	143TTGR16005	✓	\$941	E7	84.0	1.6	38	14.50	TS
	1800	208-230/460	56H	N	K2111	5K49NN4580	✓	\$823	F1	80.0	4.8-4.8/2.4	42	14.08	
	1800	208-230/460	145T	Y	I508	145TTGR16038	✓	\$963	E7	86.5	4.7-4.6/2.3	42	16.00	TS
	1800	575	145T	Y	I509	145TTGR16030	✓	\$963	E7	86.5	1.85	42	16.00	A,TS
2	3600	208-230/460	145T	N	K2205	5KE49SN8355	✓	\$1,207	E7	84.0	5.6-5.2/2.6	47	15.00	d,TS,18
	3600	208-230/460	145T	Y	I512	145TTGR16002	✓	\$1,411	E7	85.5	5.6-5.0/2.5	47	16.50	TS
	3600	575	145T	Y	I513	145TTGR16004	✓	\$1,411	E7	85.5	2.0	47	16.50	TS
	1800	208-230/460	145T	Y	I514	145TTGR16040	✓	\$1,176	E7	86.5	6.0-5.6/2.8	55	16.50	A,TS
	1800	575	145T	Y	I515	145TTGR16039	✓	\$1,176	E7	86.5	2.4	55	16.50	A,TS

Catalog numbers (Cat No.) highlighted in bold blue have efficiency levels that meet EISA requirements



Hazardous Duty™ Division 1 Explosion Proof Class I and II, Groups C, D, F & G

Severe Duty, Standard and NEMA Premium Efficiencies, Three Phase

Features:	56 Frame	143-256TC
Frame Construction	Rolled Steel	Cast Iron "Blue Chip"
Thermal Protection	Auto Overload	T-Stats
Class/Group	Class I, Groups C & D, Class II, Groups F & G	Class I, Group D Class II, Groups F & G
Temperature Code	T3B	T3B
Conduit Box	Shipped Loose	Installed
Service Factor	1.0 (unless otherwise noted)	1.0 (unless otherwise noted)
UL File	E12044	E12044
CSA File	LR47504	LR47504



EXPLOSION PROOF

C-Face Footless

HP	RPM	VOLTS	FRAME	CAT. NO.	MODEL NO.	STOCK	CT SPEED RANGE*	LIST PRICE	MULT. SYMB.	NOM. EFF.	F.L. AMPS	WEIGHT	"C" DIM.	FOOT NOTES
1/4	1800	208-230/460	56C	G827	56T17E5310	✓	-----	\$512	F1	71.0	25	1.1-1.1/0.55	11.97	CD,N
	1800	575	56C	G842	56T17E5312		-----	\$512	F1	71.0	25	0.43	11.97	CD,N
1/3	1800	208-230/460	56C	G828	56T17E5311	✓	-----	\$541	F1	74.5	25	1.3-1.2/0.6	11.97	CD,N
	1800	575	56C	G843	56T17E5313	✓	-----	\$541	F1	74.5	25	0.50	11.97	CD,N
1/2	1800	208-230/460	56C	G829	56T17G5315	✓	-----	\$570	F1	68.0	28	2.3-2.4/1.2	13.94	CD
	1800	208-230/460	56C	K2112	5K49JN4576	✓	-----	\$570	F1	68.0	29	2.3-2.4/1.2	13.94	d,CD
	1800	575	56C	G844	56T17G5318		-----	\$570	F1	68.0	32	1.0	13.94	CD
3/4	1800	208-230/460	56C	G840	56T17G5316	✓	-----	\$601	F1	75.5	29	2.9-3.0/1.5	13.94	CD
	1800	208-230/460	56C	K2113	5K49JN4577	✓	-----	\$601	F1	75.5	31	2.6-3/1.5	13.94	d,CD
	1800	575	56C	G845	56T17G5319	✓	-----	\$601	F1	75.5	29	1.2	13.94	CD
1	1800	208-230/460	56C	G841	56T17G5317	✓	-----	\$608	F1	77.0	30	3.5-3.6/1.8	13.94	CD
	1800	208-230/460	56C	K2114	5K49LN4578	✓	-----	\$608	F1	77.0	38	3.5-3.6/1.8	13.94	d,CD
	1800	575	56C	G846	56T17G5320	✓	-----	\$608	F1	77.0	32	1.45	13.94	CD
1 1/2	1800	208-230/460	143TC	C320A	143TTGN4062	✓	10:1	\$748	E7	82.5	55	3.4-3.6/1.8	15.18	18,68
	3600	208-230/460	143TC	C301A	143TTGN4020		10:1	\$777	E7	82.5	54	4.6-4.4/2.2	15.18	18,68
2	1800	208-230/460	56C	K2115	5K49NN4581		-----	\$868	F1	80.0	38	3.6-4.8/2.4	14.44	18,CD
	1800	208-230/460	145TC	C321A	145TTGN4337	✓	10:1	\$791	E7	84.0	60	4.6-4.4/2.2	15.18	18,68
2	3600	208-230/460	145TC	C302A	145TTGN4022		2:1	\$844	E7	84.0	59	5.6-5.4/2.7	13.98	18,68
	1800	208-230/460	145TC	C322A	145TTGN4338	✓	10:1	\$834	E7	84.0	69	6.0-5.6/2.8	15.18	18,68
3	3600	208-230/460	182TC	C303A	182TTGN4315	✓	10:1	\$928	E7	85.5	119	8.4-7.4/3.7	18.62	68
	1800	230/460	182TC	C323A	182TTGN4068	✓	2:1	\$992	E7	87.5	112	8.8-8.0/4.0	18.62	68
5	3600	208-230/460	184TC	C304A	184TTGN4313	✓	2:1	\$1,165	E7	87.5	133	12.4-11.8/5.9	18.62	68
	1800	208-230/460	184TC	C324A	184TTGN4072	✓	2:1	\$1,078	E7	87.5	132	14.7-13/6.5	18.62	68
7 1/2	3600	230/460	213TC	C305	213TTGS14015	✓	2:1	\$1,543	E7	88.5	241	19.0/9.5	22.25	68
	1800	208-230/460	213TC	C325A	213TTGN4067	✓	2:1	\$1,474	E7	89.5	194	22.0-20.0/10.0	23.45	68
10	3600	230/460	215TC	C306	215TTGS14020	✓	2:1	\$1,703	E7	90.2	271	24.0/12.0	22.25	68
	1800	208-230/460	215TC	C326A	215TTGN4065	✓	2:1	\$1,688	E7	89.5	216	27.2-25.0/12.5	23.45	68
15	3600	230/460	254TC	C307A	254TTGP14013	✓	2:1	\$2,210	E7	90.2	331	35/17.5	24.19	68
	1800	230/460	254TC	C327A	254TTGN14042	✓	2:1	\$2,176	E7	91.0	370	39/19.5	25.77	68
20	3600	230/460	256TC	C308A	256TTGN14011		2:1	\$2,654	E7	90.2	340	47.0/23.5	25.77	68
	1800	208-230/460	256TC	C328A	256TTGN14044	✓	2:1	\$2,721	E7	91.0	315	50.0/25.0	25.94	68

Catalog numbers (Cat No.) highlighted in bold blue have efficiency levels that meet EISA requirements

Blue shaded areas are Cast Iron Frames

Hazardous Duty™ Division 1 Explosion Proof Class I and II, Groups C (as noted), D, F & G

Blue Chip® Severe Duty, EAct Efficiency, Three Phase

Features:

- 1.15 Service Factor on sinewave
- 10:1 Variable torque, constant torque speed range as indicated @1.0 SF
- Class F insulation
- CR200 Corona Resistant, 200OC rated magnet wire
- Ball Bearings (except as noted)
- All cast iron construction
- Normally closed thermostats (must be connected to control circuit)
- Meets temperature code T3B
- Shaft slinger
- External surface treated with epoxy
- Nameplated 60/50 hertz, 190/380 volts, at next lower horsepower (575 volt excluded)
- See Modification section for addition of C-Face Kits (254T-445T)
- Meets IEEE45 USCG Marine Duty, IP 54 construction
- Contact Marathon Electric for F2 mounting
- UL Listed File No. E12044
- CSA Certified File No. LR47504,
- Two year warranty



EXPLOSION PROOF

Rigid Base

HP	RPM	VOLTS	FRAME	GROUP C	CAT. NO.	MODEL NO.	STOCK	CT SPEED RANGE	LIST PRICE	MULT. SYMB.	NOM. EFF.	F.L. AMPS	WEIGHT	"C" DIM.	FOOT NOTES
1	1800	575	143T	N	U020	143TTGN4030	✓	10:1	\$691	E7	82.5	1.2	62	13.48	d,25,80
1 1/2	1800	575	145T	N	U021	145TTGN4035	✓	10:1	\$737	E7	84.0	1.8	74	14.73	d,25,80
2	3600	208-230/460	145T	N	U059	145TTGN4001	✓	10:1	\$869	E7	84.0	5.6-5.2/2.6	64	13.48	d,25,80,91
	1800	575	145T	N	U022	145TTGN4040	✓	10:1	\$780	E7	85.5	2.4	78	14.73	d,25,80
3	1800	575	182T	N	U023	182TTGS4030	✓	10:1	\$890	E7	87.5	3.4	128	16.19	d,25
5	1800	575	184T	N	U024	184TTGS4030	✓	10:1	\$976	E7	86.5	5.2	142	17.44	d,25
7 1/2	1800	575	213T	N	U025	213TTGS4030	✓	10:1	\$1,321	E7	89.5	8.0	221	19.66	d,25
10	1800	575	215T	N	U026	215TTGS4030	✓	2:1	\$1,540	E7	89.5	10.0	225	20.91	d,25
15	1800	575	254T	Y	U027	254TTGN4030	✓	10:1	\$1,974	E7	91.0	15.6	365	23.52	d
20	1800	575	256T	Y	U028	256TTGN4030	✓	2:1	\$2,362	E7	91.0	20.0	379	25.27	d
25	1800	575	284T	Y	U029	284TTGP4030		2:1	\$3,005	E7	92.4	24.8	325	26.26	
30	1800	575	286T	Y	U030	286TTGP4030		2:1	\$3,484	E7	92.4	29.6	496	27.76	87
40	1800	575	324T	Y	U031	324TTGP4030		2:1	\$4,639	E7	93.0	40.0	520	28.97	17,87
50	3600	230/460	326TS	Y	U069	326TSTGP4001	✓	2:1	\$6,275	E7	92.4	115/57.5	622	28.97	d
	1800	575	326T	Y	U032	326TTGP4030		2:1	\$5,647	E7	93.0	49.0	520	30.47	17,87
60	1800	575	364T	Y	U033	364TTGS4040		2:1	\$8,204	E7	93.6	57.5	1055	31.5	87
	1200	230/460	404T	Y	U089	404TTGS4087	✓	2:1	\$10,690	E7	93.6	149/74.5	1289	35.62	d
75	3600	230/460	365TS	Y	U071	365TSTGS4001	✓	2:1	\$10,364	E7	93.0	172/86.0	1057	30.38	d
	1800	575	365T	Y	U034	365TTGS4040		2:1	\$10,094	E7	94.1	71.0	1094	32.5	87
100	1200	230/460	405T	Y	U088	405TTGS4087	✓	2:1	\$12,432	E7	93.6	185/92.5	1398	37.12	d
	1800	230/460	405T	Y	U097	405TTGS4046	✓	2:1	\$12,412	E7	94.5	228/114	1355	37.12	d
125	1800	575	405T	Y	U035	405TTGS4040		2:1	\$12,412	E7	94.5	91.0	1365	37.12	87
	1800	575	444T	Y	U036	444TTGS4042		2:1	\$16,030	E7	94.5	113.0	1808	41.25	87
150	1800	575	445T	Y	U037	445TTGN4030		10:1	\$19,798	E7	95.0	138.0	2236	43.19	
200	1800	575	445T	Y	U038	445TTGN4045		2:1	\$22,400	E7	95.0	180.0	2384	43.19	RB,87

Blue shaded areas are Cast Iron Frames



Hazardous Duty™ Division 1 Explosion Proof, NEMA Premium® XRI®, Class I and II, Groups C, D, F & G Blue Chip® Severe Duty, Three Phase

Features:

⚡ Meets NEMA Premium® efficiencies

- 10:1 Variable torque, see Inverter Duty column for constant torque
- MAX GUARD® Class F insulation
- Blue Chip® quality, 100% cast iron construction for rigidity and reduced vibration
- Internal and external surfaces treated with epoxy paint
- 1.15 Service Factor on sinewave or 1.0 Service Factor on IBGT power
- Precision balanced to .08"/sec.
- Extended grease tubes
- Normally closed thermostats (must be connected to control circuit)
- Meets temperature code T3B
- Shaft slinger
- Nameplated 60/50 Hz, 190/380 Volts, at next lower HP, as noted
- See MOD CENTRAL for:
 - C-Face Kit Modifications
 - F2 mounting
- Ball Bearings (except as noted)
- UL Listed File No. E12044
- CSA Certified File No. LR47504
- Three year warranty



Rigid Base

HP	RPM	VOLTS	FRAME	GROUP C	CAT. NO.	MODEL NO.	STOCK	CT SPEED RANGE	LIST PRICE	MULT. SYMB.	NOM. EFF.	F.L. AMPS	WEIGHT	"C" DIM.	FOOT NOTES
3/4	1200	208-230/460	143T	N	H350	143TTGN7076	✓	10:1	\$721	E7	74.0	3.1-3.2/1.6	55	12.48	25,68,80,91
1	1800	208-230/460	143T	N	U001A	143TTGN6526	✓	10:1	\$804	E7	85.5	3.0-3.0/1.5	68	13.48	25,68,80,91
	1800	575	143T	N	U020A	143TTGN6530	✓	10:1	\$804	E7	85.5	1.3	68	14.73	25,80
	1800	208-230/460	143T	Y	U986A	143TTGN6532		10:1	\$969	E7	85.5	3.0-3.0/1.5	68	13.48	25,80,91
	1200	208-230/460	145T	N	U039A	145TTGN6576	✓	10:1	\$969	E7	82.5	4.0-3.6/1.8	76	14.73	25,68,80,91
1 1/2	3600	208-230/460	143T	N	U058A	143TTGN6501	✓	10:1	\$861	E7	84.0	4.4-4.0/2.0	70	13.48	25,68,80,91
	1800	208-230/460	143T	N	U002A	145TTGN6526	✓	10:1	\$858	E7	86.5	4.7-4.6/2.3	83	14.73	25,68,80,91
	1800	575	145T	N	U021A	145TTGN6537	✓	10:1	\$858	E7	86.5	1.8	85	14.73	25,80
	1800	208-230/460	145T	Y	U987A	145TTGN16532		10:1	\$1,031	E7	86.5	4.7-4.6/2.3	81	14.73	25,80,91
2	1200	208-230/460	182T	N	U040A	182TTGN6576	✓	10:1	\$1,010	E7	87.5	4.8-4.4/2.2	147	15.87	25,68,91
	3600	208-230/460	145T	N	U059A	145TTGN6501	✓	10:1	\$1,010	E7	85.5	5.6-5.2/2.6	70	13.48	25,68,80,91
	1800	208-230/460	145T	N	U003A	145TTGN6527	✓	10:1	\$908	E7	86.5	6.2-6.0/3.0	86	14.73	25,68,80,91
	1800	575	145T	N	U022A	145TTGN6540	✓	10:1	\$908	E7	86.5	2.4	86	14.73	25,80
3	1800	208-230/460	145T	Y	U988A	145TTGN6550		10:1	\$1,093	E7	86.5	6.2-6.0/3.0	83	14.73	25,80,91
	1200	208-230/460	184T	N	U041A	184TTGN6576	✓	10:1	\$1,143	E7	88.5	6.4-6.0/3.0	154	17.87	25,68,91
	3600	208-230/460	182T	N	U060A	182TTGN6501	✓	10:1	\$1,045	E7	86.5	8.4-7.6/3.8	141	15.87	25,68,91
	1800	208-230/460	182T	N	U004A	182TTGN6526	✓	10:1	\$1,035	E7	89.5	8.4-8.0/4.0	143	15.87	25,68,91
5	1800	575	182T	N	U023A	182TTGN6530	✓	10:1	\$1,035	E7	89.5	3.2	141	15.87	25
	1800	208-230/460	182T	Y	U989A	182TTGN6541		10:1	\$1,245	E7	89.5	8.4-8.0/4.0	161	15.87	25,68,91
	1200	208-230/460	213T	N	U042A	213TTGN6576	✓	10:1	\$1,464	E7	89.5	8.8/4.4	244	19.63	25,68
	3600	208-230/460	184T	N	U061A	184TTGN6501	✓	10:1	\$1,270	E7	88.5	13.0-12.0/6.0	161	17.87	25,68,91
5	1800	208-230/460	184T	N	U005A	184TTGN6526	✓	10:1	\$1,135	E7	89.5	13.8-12.4/6.2	155	17.87	25,68,91
	1800	575	184T	N	U024A	184TTGN6530	✓	10:1	\$1,135	E7	89.5	5.0	156	17.87	25
	1800	208-230/460	184T	Y	U990A	184TTGN6544		10:1	\$1,366	E7	89.5	13.8-12.4/6.2	150	17.87	25,68,91
	1200	230/460	215T	N	U043A	215TTGN6576	✓	10:1	\$1,876	E7	89.5	13.8/6.9	206	22.63	25,68

Catalog numbers (Cat No.) highlighted in bold blue have efficiency levels that meet EISA requirements

Blue shaded areas are Cast Iron Frames

Continued on next page.

Hazardous Duty™ Division 1 Explosion Proof, NEMA Premium® XRI®, Class I and II, Groups C, D, F & G Blue Chip® Severe Duty, Three Phase

Rigid Base

HP	RPM	VOLTS	FRAME	GROUP C	CAT. NO.	MODEL NO.	STOCK	CT SPEED RANGE	LIST PRICE	MULT. SYMB.	NOM. EFF.	F.L. AMPS	WEIGHT	"C" DIM.	FOOT NOTES
7 1/2	3600	208-230/460	213T	N	U062A	213TTGN6501	✓	10:1	\$1,619	E7	89.5	20.0-19.0/9.5	256	19.63	25,68,91
	1800	208-230/460	213T	N	U006A	213TTGN6526	✓	10:1	\$1,536	E7	91.7	20.8-19.2/9.6	248	19.63	25,68,91
	1800	575	213T	N	U025A	213TTGN16537	✓	10:1	\$1,536	E7	91.7	7.7	243	19.63	25
	1800	208-230/460	213T	Y	U991A	213TTGN6540		10:1	\$1,849	E7	91.7	20.8-19.2/9.6	251	19.63	25,68,91
10	1200	230/460	254T	Y	E500	254TTGN6576	✓	10:1	\$2,246	E7	91.0	19.8/9.9	345	23.52	68
	3600	230/460	215T	Y	U063A	215TTGN6501	✓	10:1	\$1,838	E7	90.2	23.6/11.8	265	22.63	25,68
	1800	208-230/460	215T	N	U007A	215TTGN6526	✓	10:1	\$1,791	E7	91.7	27.0-25.0/12.5	263	22.63	25,68,91
	1800	575	215T	N	U026A	215TTGN16532	✓	10:1	\$1,791	E7	91.7	10.0	248	22.63	25
15	1800	208-230/460	215T	Y	U992A	215TTGN6539		10:1	\$2,156	E7	91.7	25.0/12.5	253	22.63	25,68
	1200	230/460	256T	Y	E501	256TTGN6576	✓	10:1	\$2,709	E7	91.0	26.2/13.1	360	25.27	68
	3600	230/460	254T	Y	E502	254TTGN6507	✓	10:1	\$2,196	E7	91.7	35.0/17.5	253	23.52	68
	1800	230/460	254T	Y	E503	254TTGN6531	✓	10:1	\$2,183	E7	92.4	37.5/18.8	385	23.52	68
20	1800	575	254T	Y	U027A	254TTGN16541	✓	10:1	\$2,183	E7	92.4	15.1	402	23.52	
	1200	230/460	284T	Y	E504	284TTGN6576	✓	10:1	\$3,763	E7	91.7	41.0/20.4	536	26.34	68
	3600	208-230/460	256T	Y	E505	256TTGN16509	✓	10:1	\$3,223	E7	92.4	51-47/23.4	275	25.27	68
	1800	230/460	256T	Y	E506	256TTGN6531	✓	10:1	\$2,584	E7	93.0	48.0/24.1	409	25.27	68
25	1800	575	256T	Y	U028A	256TTGN16540	✓	10:1	\$2,584	E7	93.0	19.3	417	25.27	
	1200	230/460	286T	Y	E507	286TTGN16577	✓	10:1	\$4,388	E7	91.7	53.6/26.8	593	27.69	
	3600	230/460	284TS	Y	E546	284TSTGN6503	✓	10:1	\$3,572	E7	93.6	56.0/28.1	412	24.97	68
	1800	230/460	284T	Y	E547	284TTGN6533	✓	10:1	\$3,287	E7	93.6	62.0/31.0	536	26.34	68
30	1800	575	284T	Y	U029A	284TTGN16539		10:1	\$3,287	E7	93.6	24.8	358	26.34	
	1800	230/460	284TS	Y	U076A	284TSTGN16531		10:1	\$3,287	E7	93.6	62.0/31.0	484	24.97	68
	1200	230/460	324T	Y	U048A	324TTGS16577	✓	10:1	\$6,458	E7	93.0	65.0/32.5	681	28.87	68
	3600	230/460	286TS	Y	E563	286TSTGN6501	✓	10:1	\$3,849	E7	93.6	67.5/34.0	487	26.47	68
40	1800	230/460	286T	Y	E564	286TTGN6537	✓	10:1	\$3,811	E7	94.1	80.0-73.0/36.5	588	27.84	68
	1800	575	286T	Y	U030A	286TTGN16533		10:1	\$3,811	E7	93.6	29.2	546	27.84	
	1800	208-230/460	286TS	Y	U077A	286TSTGN16531		10:1	\$3,811	E7	93.6	80.0-73.0/36.5	462	26.47	68
	1200	230/460	326T	Y	E565	326TTGS6578		10:1	\$7,021	E7	93.0	77.0/38.5	900	30.37	68
50	3600	230/460	324TS	Y	E566	324TSTGS6501	✓	10:1	\$5,181	E7	93.6	94.0/47.0	734	28.87	68
	1800	230/460	324T	Y	E567	324TTGS6529	✓	10:1	\$5,072	E7	94.1	95.0/47.5	749	30.37	68
	1800	575	324T	Y	U031A	324TTGS16535		10:1	\$5,072	E7	94.1	38.0	572	30.37	
	1800	230/460	324TS	Y	U078A	324TSTGS16531		10:1	\$5,072	E7	94.1	95.0/47.5	770	28.87	68
60	1200	230/460	364T	Y	E568A	364TTGS16577	✓	10:1	\$8,443	E7	93.6	100/50.0	1151	31.50	68
	3600	230/460	326TS	Y	E569	326TSTGS6501	✓	10:1@	\$6,570	E7	93.6	118/59.0	831	30.37	68
	1800	230/460	326T	Y	E570	326TTGS6532	✓	10:1@	\$6,177	E7	94.5	123/61.5	791	30.37	68
	1800	575	326T	Y	U032A	326TTGS16539		10:1@	\$6,177	E7	94.5	49.0	572	30.37	68
75	1800	208-230/460	326TS	Y	U079A	326TSTGS16532		10:1@	\$6,177	E7	94.5	120/60.0	688	28.87	68
	1200	230/460	365T	Y	E571	365TTGS16577	✓	10:1@	\$9,135	E7	94.5	123/61.5	1099	32.50	87
	3600	230/460	364TS	Y	E572	364TSTGS6506	✓	10:1@	\$9,544	E7	94.5	134/67.0	1033	29.38	87
	1800	230/460	364T	Y	E573A	364TTGS16536	✓	10:1@	\$9,484	E7	95.0	138/69.0	1178	31.50	87
100	1800	575	364T	Y	U033A	364TTGS16537		10:1@	\$9,484	E7	95.0	55.0	1161	31.50	
	1800	208-230/460	364TS	Y	U080A	364TSTGS16531		10:1@	\$9,484	E7	95.0	138/69.0	1145	29.38	68
	1200	230/460	404T	Y	E574	404TTGS6588	✓	10:1@	\$11,407	E7	94.5	144/72.0	1295	35.62	
	3600	230/460	365TS	Y	E575	365TSTGS16503	✓	10:1@	\$11,060	E7	94.1	169/84.5	1097	30.38	87
150	1800	230/460	365T	Y	E576A	365TTGS16540	✓	2:1	\$11,007	E7	95.4	174/87.0	1124	32.50	A,68
	1800	575	365T	Y	U034A	365TTGS16542		2:1	\$11,007	E7	95.4	69.0	1094	32.50	A
	1800	208-230/460	365TS	Y	U081A	365TSTGS16532		2:1	\$11,007	E7	95.4	174/87	1087	30.38	A,68
	1200	230/460	405T	Y	E577	405TTGS6589	✓	10:1@	\$13,283	E7	94.5	180/90.0	1388	37.12	87

EXPLOSION PROOF

Catalog numbers (Cat No.) highlighted in bold blue have efficiency levels that meet EISA requirements

Blue shaded areas are Cast Iron Frames

@ Requires larger fan

Continued on next page.



Hazardous Duty™ Division 1 Explosion Proof, NEMA Premium® XRI®, Class I and II, Groups C, D, F & G Blue Chip® Severe Duty, Three Phase

Rigid Base

EXPLOSION PROOF

HP	RPM	VOLTS	FRAME	GROUP C	CAT. NO.	MODEL NO.	STOCK	CT SPEED RANGE	LIST PRICE	MULT. SYMB.	NOM. EFF.	F.L. AMPS	WEIGHT	"C" DIM.	FOOT NOTES
100	3600	230/460	405TS	Y	E578	405TSTGS6503		10:1	\$14,962	E7	94.5	216/108	1349	34.12	87
	1800	230/460	405T	Y	E594	405TTGS6548	√	2:1	\$13,577	E7	95.4	226/113	1479	37.12	68
	1800	575	405T	Y	U035A	405TTGS16539		2:1	\$13,577	E7	95.4	90.5	1365	37.12	87
	1800	208-230/460	405TS	Y	U082A	405TSTGS16531		2:1	\$13,577	E7	95.4	226/113	1333	34.12	87
	1200	230/460	444T	Y	E580A	444TTGN16580	√	10:1@	\$18,980	E7	95.0	248/124	1813	41.35	68,87
125	3600	460	444TS	Y	U073A	444TSTGN16502		2:1	\$24,057	E7	94.5	139	1824	36.70	68
	1800	460	444T	Y	E582A	444TTGN16532	√	10:1@	\$19,926	E7	95.4	143	1845	41.35	68
	1800	575	444T	Y	U036A	444TTGN16533		10:1@	\$19,926	E7	95.4	114	1808	41.35	
	1800	460	444TS	Y	U083A	444TSTGN16531		10:1@	\$19,926	E7	95.4	143	1835	37.60	
	1200	460	445T	Y	E583	445TTGN6597		---	\$21,820	E7	95.0	155	2200	43.25	
150	3600	460	445TS	Y	E584	445TSTGN16505		---	\$28,159	E7	95.0	168	1941	39.60	
	1800	460	445T	Y	E585	445TTGN6542	√	10:1	\$20,729	E7	95.4	172	2173	43.35	68
	1800	575	445T	Y	U037A	445TTGN16544		10:1	\$20,729	E7	95.4	138	2236	43.35	
	1800	460	445TS	Y	U084A	445TSTGN16531		10:1	\$20,729	E7	95.4	172	2163	39.60	68
	1200	460	445T	Y	U090A	445TTGN16588		---	\$23,454	E7	95.8	181	2384	43.35	RB,68
200	3600	460	445TS	Y	U075A	445TSTGN16506		---	\$34,359	E7	95.4	226	2395	39.6	
	1800	460	445T	Y	E588	445TTGN6538		10:1@	\$23,500	E7	96.2	224	2500	43.19	68
	1800	575	445T	Y	U038A	445TTGN16543		10:1@	\$23,500	E7	96.2	179	2384	43.35	RB
	1200	460	449T	Y	U091A	449TTGS16585		10:1	\$33,349	E7	95.8	240	2878	51.85	RB,68
250	3600	460	449TS	Y	E595	449TSTGS14003		---	\$34,888	E7	96.5	275	2867	47.94	68,87
	1800	460	449T	Y	E591	449TTGS16537		10:1	\$28,830	E7	96.5	285	3012	51.85	RB
	1800	460	449T	Y	H502	449TTGS7068		2:1	\$26,974	E7	95.0	290	2779	51.85	RB,17,68,87
300	1800	460	449T	Y	H503	449TTGS7037		2:1	\$30,039	E7	96.5	338	3032	51.85	RB,17,68,87
350	1800	460	449T	Y	H504	449TTGS7036		---	\$33,688	E7	96.2	400	3280	51.85	RB,17

Catalog numbers (Cat No.) highlighted in bold blue have efficiency levels that meet EISA requirements

Blue shaded areas are Cast Iron Frames

@ Requires larger fan

"R164 Rework" Table:

R-164 Rework for 10:1 Constant Torque:
Fan Change* & Re-Nameplate

FRAME	LIST PRICE
143-215	\$230
254-286	\$263
324-326	\$296
364-365	\$296
404-449	\$329

Multiplier Symbol S4

*Fan change to allow 10:1 constant torque may reduce motor full load efficiency below EPA levels.

Operation of motor on non-sinusoidal wave form (VFD) exempts motor from EPA mandated efficiency levels.

Medium Voltage Motors

Marathon Electric's Medium Voltage motors are available through 3000 horsepower, and through 13.2 kV (13,200 volts). Enclosures include Dripproof (ODP), WP1, WP11, Totally Enclosed Fan Cooled (TEFC), Totally Enclosed Air-to-Air Cooled (TEAAC) and Totally Enclosed Water-to-Air Cooled (TEWAC). Contact Marathon Electric for a quotation on any ratings or configurations not listed below.



<p>Marathon MV ODP NEMA Range: 125-700HP Voltage: 2300/4000v Pole: 2-, 4-, 6-, 8-pole Freq: 60 Hertz Frame: 449T-510U NEMA Protection: IP23 Ambient: 40° C Insulation: Class H VPI Construction: CI Performance: MG1 Bearings: Anti-Friction Service Factor: 1.15 Inverter: Yes Warranty: 12/18 mo.</p>	<p>Marathon MV WPI IEC Range: 250-3000HP Voltage: 2300/4000V Pole: 2-, 4-, 6-, pole Freq: 60 Hertz Frame: 355-630 IEC Protection: IP23 Ambient: 40° C Insulation: Class F VPI Construction: Fab Performance: IEC Bearings: Anti-Friction Service Factor: 1.15 Inverter: Yes Warranty: 12/24 mo.</p>	<p>Marathon MV WP11 IEC Range: 250-3000HP Voltage: 2300/4000V Pole: 2-,4-,6- pole Freq: 60 Hertz Frame: 355-630 IEC Protection: IPW23 Ambient: 40° C Insulation: Class F VPI Construction: Fab Performance: IEC Bearings: Anti-Friction Service Factor: 1.15 Inverter: Yes Warranty: 12/24 mo.</p>	<p>Marathon MV TEFC NEMA Range: 200-750HP Voltage: 2300/4000v Pole: 2-, 4-, 6-, pole Freq: 60 Hertz Frame: 5011-5013 NEMA Protection: IP55 Ambient: 40° C Insulation: Class H VPI Construction: CI Performance: MG1 Bearings: Anti-Friction Service Factor: 1.15 Inverter: Yes Warranty: 12/18 mo.</p>	<p>Marathon MV TEFC IEC Range: 250-2500HP Voltage: 2300/4000V Pole: 2-, 4-, 6-, pole Freq: 60 Hertz Frame: 355-560 IEC Protection: IP55 Ambient: 40° C Insulation: Class F VPI Construction: CI Performance: IEC Bearings: Anti-Friction Service Factor: 1.15 Inverter: Yes Warranty: 12/24 mo.</p>	<p>Marathon MV TEAAC IEC Range: 300-3000 HP Voltage: 2300/4000V Pole: 2-,4-,6- pole Freq: 60 Hertz Frame: 355-630 IEC Protection: IP44 Ambient: 40° C Insulation: Class F VPI Construction: Fab Performance: IEC Bearings: Anti-Friction Service Factor: 1.15 Inverter: Yes Warranty: 12/24 mo.</p>
---	--	---	--	--	--

MEDIUM VOLTAGE

Features:

	Dripproof, 449-510 frame	Totally Enclosed, 449 frame	Totally Enclosed, 5000 frame
NEMA Premium efficiencies as noted (Table 12-13)	X	X	X
Cast iron construction B-10 life on direct-coupled loads	X	X	X
Open Conrad radial ball bearings rated for 100,000 hour B-10 life on direct-coupled loads	X	X	X
Roller bearing for belted loads	OPT	OPT	OPT
Oversized, fabricated steel conduit box	X		
Oversized, cast iron conduit box		X	X
1.15 Service Factor as available (consult factory)	OPT	OPT	OPT
Class H insulation and form wound coils	X	X	X
Epoxy, 100% solids, Vacuum Pressure Impregnation (VPI) resin	X	X	X
Grease fittings with extended grease tubes		X	X
Internal and external epoxy finish		X	X
Front and rear cast iron bearing caps		X	X
Actual test and vibration data included with each order		X	X
CSA Certified for Div. 2/Zone 2, Group A, B, C, D		X	X
and Group IIA, IIB, IIC		X	X
Temp Code T3 @ 1.0 Service Factor		X	
Temp Code T2C @ 1.0 Service Factor			X
Temp Code T2B @ 1.15 Service Factor		X	X
IEEE-841 features		OPT	OPT
Provisions for jacking bolts in all four feet			X
Rotating shaft seals, Inpro® Smart Rings on each end			X
Provisions for dowel pins in drive end feet			X
Ground provisions on foot and in the conduit box			X
Dedicated 5009 frame for vertical applications			X
Frames drilled with four sets of footholes, 5009, 5010, 5011, 5012			X

Medium Voltage Motors

Multipler Symbol S4

HP	RPM	DRIPPROOF				TOTALLY ENCLOSED			
		NEMA PREMIUM	FRAME	CAT. NO.	LIST PRICE	NEMA PREMIUM	FRAME	CAT. NO.	LIST PRICE
100	900	---	---	---	---	N/A	447/9T	Y255	\$44,021
125	1800	---	---	---	---	N/A	L447/9T	Y256	\$36,841
	1200	---	---	---	---	N/A	447/9T	Y257	\$46,638
	900	N/A	449T	Y948	\$31,755	N/A	5011LS	Y913	\$50,854
150	3600	---	---	---	---	N/A	447/9TS	Y903	\$40,169
	1800	---	---	---	---	N/A	L447/9T	Y900	\$38,365
	1200	---	---	---	---	N/A	447/9T	Y904	\$48,291
	900	N/A	508U	Y949	\$36,639	N/A	5011LS	Y914	\$55,271
200	3600	---	---	---	---	N/A	L447/9TS	Y905	\$42,734
	1800	N/A	449T	Y950	\$30,612	N/A	L447/9T	Y901	\$40,799
	1200	N/A	449T	Y958	\$33,408	N/A	L447/9T	Y906	\$48,853
	1200	---	---	---	---	N/A	5011LS	Y920	\$49,763
	900	N/A	508U	Y250	\$42,366	N/A	5011LS	Y915	\$58,343
250	3600	N/A	449TS	Y954	\$36,953	N/A	5011S	Y258	\$53,013
	1800	N/A	449T	Y951	\$32,220	Y	L447/9T	Y902	\$44,352
	1200	N/A	508U	Y955	\$35,172	Y	L447/9T	Y907	\$54,020
	1200	---	---	---	---	Y	5011LX	Y921	\$55,424
	900	N/A	510U	Y251	\$46,048	N/A	5011LS	Y916	\$60,035
300	3600	N/A	449TS	Y956	\$38,415	N/A	5011S	Y259	\$54,624
	1800	---	---	---	---	Y	L447/9T	Y908	\$49,927
	1800	N/A	508U	Y952	\$35,163	Y	5011LS	Y922	\$52,040
	1200	N/A	508U	Y942	\$38,140	Y	5011LS	Y923	\$58,781
	900	N/A	510U	Y252	\$59,657	N/A	5013LS	Y917	\$69,192
350	3600	N/A	449TS	Y957	\$39,892	N/A	5011S	Y260	\$55,430
	1800	N/A	508U	Y953	\$36,435	Y	5011LS	Y924	\$52,770
	1200	N/A	508U	Y943	\$41,168	Y	5011LS	Y925	\$61,156
	1200	---	---	---	---	Y	5011LX	Y935	\$64,542
	900	---	---	---	---	N/A	5013LS	Y918	\$77,531
400	3600	N/A	449TS	Y910	\$40,857	N/A	5011S	Y261	\$61,100
	1800	Y	508U	Y940	\$37,684	Y	5011LS	Y926	\$56,443
	1800	---	---	---	---	Y	5011LX	Y936	\$59,800
	1200	Y	510U	Y944	\$51,191	Y	5011LS	Y927	\$67,101
	900	---	---	---	---	N/A	5013LS	Y912	\$93,376
450	3600	---	---	---	---	N/A	5011S	Y263	\$63,146
	1800	Y	508US	Y911	\$44,726	Y	5011LS	Y928	\$60,119
	1800	Y	510U	Y941	\$40,660	Y	5011LX	Y937	\$63,474
	1200	Y	510U	Y945	\$60,053	Y	5013LS	Y929	\$72,852
	900	---	---	---	---	N/A	5013LS	Y262	\$96,676
500	1800	Y	510U	Y946	\$49,470	Y	5011LS	Y930	\$66,129
	1800	---	---	---	---	Y	5011LX	Y938	\$69,486
	1200	Y	510U	Y947	\$73,192	Y	5013LS	Y931	\$77,748
600	1800	N/A	510U	Y253	\$60,366	N/A	5011LS	Y932	\$86,835
	1800	---	---	---	---	N/A	5011LX	Y939	\$90,191
700	1800	N/A	510U	Y254	\$63,514	N/A	5013LS	Y933	\$92,869
800	1800	---	---	---	---	N/A	5013LS	Y934	\$99,622

MEDIUM VOLTAGE

Inverter (Vector) Duty: microMAX™ 1000:1 Constant Torque (TENV), 20:1 Constant Torque (TEFC)

Totally Enclosed, Three Phase

Applications:

Designed for direct replacement of PMDC or any other variable speed application where up to a 1000:1 constant torque speed range is required. Typical uses include: machine tools, conveyors, packaging machines, batching machines, and printing equipment.



Features:

- Designed to replace PMDC motors (when used with a VFD)
- Constant horsepower to twice base speed (RPM)
- Class H insulation with CR200 magnet wire
- Removable base for C-Face footless mounting, as noted
- Continuous duty at 40°C ambient
- “Quick Connect” terminal board, as noted
- Top mounted conduit box found on PMDC motors
- Eliminates brush and commutator maintenance
- UL Recognized, CSA Certified, and CE Mark
- Three year warranty

C-Face Footless

HP	RPM	VOLTS	FRAME	CAT. NO.	MODEL NO.	STOCK	LIST PRICE	MULT. SYMB.	F.L. AMPS	WEIGHT	“C” DIM.	FOOT NOTES
1/8	1800	230	56C	Y606	56H17T2022	✓	\$235	E3	0.7	15	9.05	N,Q
1/4	1800	230	56C	Y501	56H17T2012	✓	\$254	E3	1.0	16	9.80	N,Q
1/3	1800	230	56C	Y503	56H17T2014	✓	\$274	E3	1.2	17	9.80	N,Q
1/2	1800	230	56C	Y505	56H17T2016		\$322	E3	1.8	24	10.55	N,Q
	1800	230/460	56C	Y374	56H17T2018	✓	\$322	E3	1.8/0.9	24	10.55	N
	1800	575	56C	Y375	56H17T2020		\$322	E3	0.7	24	10.55	N,Q
3/4	1800	230	56C	Y507	56H17F2012		\$398	E3	2.8	21	11.19	
	1800	230/460	56C	Y376	56H17F2018	✓	\$398	E3	2.8/1.4	21	11.19	
	1800	575	56C	Y377	56H17F2016		\$398	E3	1.1	21	11.19	
1	1800	230	56C	Y521	56H17F2014		\$448	E3	3.2	27	12.44	
	1800	230/460	56C	Y378	56H17F2022	✓	\$448	E3	3.2/1.6	27	12.44	
	1800	575	56C	Y379	56H17F2020		\$448	E3	1.3	27	12.44	

C-Face Footed (Rigid Base)

HP	RPM	VOLTS	FRAME	CAT. NO.	MODEL NO.	STOCK	LIST PRICE	MULT. SYMB.	F.L. AMPS	WEIGHT	“C” DIM.	FOOT NOTES
1/8	1800	230	56C	Y605	56H17T2021	✓	\$235	E3	0.7	18	9.05	N,Q
1/4	1800	230	56C	Y500	56H17T2011	✓	\$254	E3	1.0	17	9.80	N,Q
1/3	1800	230	56C	Y502	56H17T2013	✓	\$274	E3	1.2	17	9.80	N,Q
1/2	1800	230	56C	Y504	56H17T2015	✓	\$322	E3	1.8	24	10.55	N,Q
	1800	230/460	56C	Y360	56H17T2017	✓	\$322	E3	1.8/0.9	24	10.55	N
	1800	575	56C	Y361	56H17T2019	✓	\$322	E3	0.7	12	10.55	N,Q
3/4	1800	230	56C	Y506	56H17F2011	✓	\$398	E3	2.8	22	11.19	
	1800	230/460	56C	Y362	56H17F2017	✓	\$398	E3	2.8/1.4	21	11.19	
	1800	575	56C	Y363	56H17F2015		\$398	E3	1.1	22	11.19	
1	1800	230	56C	Y508	56H17F2013		\$448	E3	3.2	28	12.44	
	1800	230/460	56C	Y364	56H17F2021	✓	\$448	E3	3.2/1.6	27	12.44	
	1800	575	56C	Y365	56H17F2019	✓	\$448	E3	1.3	22	12.44	
1 1/2	1800	230	145TC	Y522	145THTR5328	✓	\$557	E3	4.8	48	13.48	N,6
	1800	230/460	145TC	Y366	145THTR5329	✓	\$557	E3	4.8/2.4	49	13.48	N,6
	1800	575	145TC	Y367	145THTR5330		\$557	E3	1.9	50	13.48	N,6
2	1800	230	145TC	Y523	145THFR5326		\$739	E3	5.8	53	14.87	6
	1800	230/460	145TC	Y368	145THFR5329	✓	\$739	E3	5.8/2.9	50	14.87	6
	1800	575	145TC	Y369	145THFR5330	✓	\$739	E3	2.3	49	14.87	6

Continued on next page.



Inverter (Vector) Duty: microMAX™

1000:1 Constant Torque (TENV), 20:1 Constant Torque (TEFC)

Totally Enclosed, Three Phase

C-Face Footed (Rigid Base)

HP	RPM	VOLTS	FRAME	CAT. NO.	MODEL NO.	STOCK	LIST PRICE	MULT. SYMB.	F.L. AMPS	WEIGHT	"C" DIM.	FOOT NOTES
3	1800	230	182/145TC	Y530	182THFR5326		\$871	E3	8.4	60	14.87	86,88
	1800	230	182TC	Y998A	182THFW7726		\$909	E3	7.8	76	14.97	6,13
	1800	230/460	182/145TC	Y370	182THFR5329	✓	\$871	E3	8.4/4.2	52	14.87	86,88
	1800	230/460	182TC	Y999	182THFR7729	✓	\$909	E3	8.4/4.2	76	16.19	d,6
	1800	230/460	182TC	Y1999	182THFW7729	✓	\$909	E3	7.8/3.9	76	14.97	6,13
	1800	575	182/145TC	Y371	182THFR5330		\$871	E3	3.4	52	14.87	86,88
	1800	575	182TC	Y270	182THFR7730	✓	\$909	E3	3.4	86	16.19	d,6
	1800	575	182TC	Y1270	182THFW7730	✓	\$909	E3	2.9	86	14.97	6,13
5	1800	230/460	184TC	Y372	184THFR7726	✓	\$1,034	E3	13.4/6.7	92	16.69	d,6
	1800	230/460	184TC	Y1372	184THFW7726	✓	\$1,034	E3	12.8/6.4	92	15.97	6,13
	1800	575	184TC	Y373	184THFR7736		\$1,034	E3	5.4	95	16.69	6
	1800	575	184TC	Y373A	184THFW7736	✓	\$1,034	E3	5.1	95	15.97	6,13
7 1/2	1800	230/460	213TC	Y994	213THFR7726	✓	\$1,322	E3	21.4/10.7	98	20.97	6
	1800	575	213TC	Y995	213THFW7736		\$1,322	E3	8.5	98	20.97	6
10	1800	230/460	215TC	Y996	215THFR7726	✓	\$1,691	E3	27.6/13.8	125	22.22	6
	1800	575	215TC	Y997	215THFW7736		\$1,691	E3	11.1	125	22.22	

Inverter (Vector) Duty: Max+ (with Encoder)

1000:1 Constant Torque, Totally Enclosed, Three Phase

Applications:

The **MAX+** incorporates low rotor inertia for fast starts, stops, and reversals. Coupled with an encoder make this useful in applications traditionally served only by servo systems. The **MAX+** is also suitable for all applications where up to a 1000:1 Constant Torque speed range or positioning is required.

Features:

- Integrated Dynapar HS20 1024 ppr encoder
- Class F insulation with CR200 corona resistant magnet wire
- Constant Torque operation from 0 to base speed on Vector Drive
- Constant Horsepower operation up to twice base RPM
- Continuous duty at 40°C ambient
- Optimized for operation with IGBT inverter
- Removable base for C-Face footless mounting, as noted
- Ball bearings
- Field reversible to F2 (except as noted)
- UL Recognized, CSA Certified, and CE Mark
- Three year warranty



Opposite drive end shown



C-Face Footed (Rigid Base)

HP	RPM	VOLTS	FRAME	ENCODER PPR	CAT. NO.	MODEL NO.	STOCK	LIST PRICE	MULT. SYMB.	F.L. AMPS	WEIGHT	"C" DIM.	FOOT NOTES
1/2	1800	230/460	56C	1024	Y280	56H17T15526	✓	\$992	E3	1.6/8	29	13.48	S,6,13
3/4	1800	230/460	56C	1024	Y281	56H17T15528	✓	\$1,038	E3	2.4/1.2	35	13.48	S,6,13
1	1800	230/460	56C	1024	Y282	56H17T15527	✓	\$1,099	E3	3/1.5	41	14.98	S,6,13
	1800	230/460	143TC	1024	Y283	143THTR15535	✓	\$1,183	E3	3/1.5	42	15.04	S,6,13
1 1/2	1800	230/460	145TC	1024	Y284	145THTR15540	✓	\$1,308	E3	4/2	50	16.04	S,6,13
2	1800	230/460	145TC	1024	Y285	145THTR17034	✓	\$1,755	E3	6/3	75	14.68	
3	1800	230/460	182TC	1024	Y286	182THTR17041	✓	\$1,972	E3	8.4/4.2	95	17.39	AL
5	1800	230/460	184TC	1024	Y287	184THTR17038	✓	\$2,147	E3	14/7	112	18.94	AL

Blue shaded areas are Cast Iron Frames

Inverter (Vector) Duty: Black Max® 1000:1 Constant Torque, TENV, Three Phase

Applications:

Designed for inverter or vector applications where up to a 1000:1 Constant Torque speed range is required. Typical uses include: material handling, machine tools, conveyors, crane and hoist, metal processing, test stands, pumps compressors, textile processing, and other industrial machinery installed in dusty or dirty environments.



Features:

- MAX GUARD® Class F insulation system
- Constant Torque operation from 0 to base speed on Vector Drive
- Constant Horsepower operation up to twice base RPM
- Continuous duty at 40°C ambient
- Optimized for operation with IGBT inverter (NEMA Design A)
- Normally closed thermostats (one per phase, Class F)
- Removable rigid base, as noted
- Ball Bearings
- Field reversible to F2 (except as noted)
- Encoder and brake provisions included on opposite drive end (maximum 10 lb-ft brake, see Modifications and/or Accessory Kits sections)
- UL Recognized, CSA Certified, and CE Mark
- Three year warranty



C-Face Footed (Rigid Base)

HP	RPM	VOLTS	FRAME	OVER LOAD	CAT. NO.	MODEL NO.	STOCK	LIST PRICE	MULT. SYMB.	F.L. AMPS	WEIGHT	"C" DIM.	FOOT NOTES
1/4	1800	230/460	56C	TSTAT	Y592	56H17T2001	✓	\$373	E3	1.2/0.6	19	11.88	S,13
1/2	1800	230/460	56C	TSTAT	Y534	56H17T5301	✓	\$467	E3	1.6/0.8	35	13.48	S,6,13
		575	56C	TSTAT	Y555	56H17T5311	✓	\$467	E3	0.6	35	13.48	S,6,13
1	1800	230/460	56C	TSTAT	Y535	56H17T5302	✓	\$557	E3	3.0/1.5	39	14.98	S,6,13
	1800	575	56C	TSTAT	Y556	56H17T5312	✓	\$557	E3	1.2	39	14.98	S,6,13
	1800	230/460	143TC	TSTAT	Y536	143THTR5326	✓	\$572	E3	3.0/1.5	48	15.04	S,6,13
1	1200	230/460	145TC	TSTAT	Y537	145THTR5376	✓	\$663	E3	3.8/1.9	49	16.04	S,6,13
	1800	230/460	145TC	TSTAT	Y538	145THTR5326	✓	\$695	E3	4.8/2.4	50	16.04	S,6,13
2	1800	230/460	145TC	TSTAT	Y551	145THTN6046	✓	\$960	E3	6.0/3.0	73	14.68	
	1800	575	145TC	TSTAT	Y557	145THTN6060	✓	\$960	E3	2.4	73	14.68	
3	1200	230/460	184TC	TSTAT	Y540	184THTL7776	✓	\$1,373	E3	6.6/3.3	88	16.94	AL
	1800	230/460	182TC	TSTAT	Y541	182THTL7726	✓	\$1,190	E3	8.4/4.2	95	17.39	AL
	1800	575	182TC	TSTAT	Y558	182THTL7736	✓	\$1,190	E3	3.4	95	17.39	AL
5	1200	230/460	213TC	TSTAT	Y542	213THTL7776	✓	\$1,691	E3	9.4/4.7	105	19.94	AL
	1800	230/460	184TC	TSTAT	Y543	184THTL7726	✓	\$1,421	E3	14.0/7.0	110	18.94	AL
	1800	575	184TC	TSTAT	Y559	184THTL7736	✓	\$1,421	E3	5.6	110	18.94	AL
7 1/2	1200	230/460	215TC	TSTAT	Y544	215THTL7776	✓	\$2,057	E3	15.4/7.7	146	20.54	AL
	1800	230/460	213TC	TSTAT	Y545	213THTL7726	✓	\$1,865	E3	21.0/10.5	146	20.54	AL
	1800	575	213TC	TSTAT	Y560	213THTL7736	✓	\$1,865	E3	8.4	146	20.54	AL
10	1200	230/460	254TC	TSTAT	Y546	254THTL5776	✓	\$2,767	E3	22.0/11.0	223	25.37	AL,I
	1800	230/460	215TC	TSTAT	Y547	215THTL7726	✓	\$2,231	E3	27.0/13.5	219	23.04	AL
	1800	575	215TC	TSTAT	Y561	215THTL7736	✓	\$2,231	E3	10.8	219	23.04	AL
15	1200	230/460	256TC	TSTAT	Y548	256THTL5776	✓	\$3,132	E3	28.0/14.0	229	26.87	AL,I
	1800	230/460	254TC	TSTAT	Y549	254THTL5726	✓	\$2,655	E3	40.0/20.0	260	26.87	I,AL
	1800	575	254TC	TSTAT	Y562	254THTL5736	✓	\$2,655	E3	16.0	260	26.87	I,AL
20	1800	230/460	256TC	TSTAT	Y552	256THTNA7026	✓	\$3,876	E3	52.0/26.0	300	27.13	
	1800	575	256TC	TSTAT	Y563	256THTNA7036	✓	\$3,876	E3	20.8	300	27.13	
25	1800	230/460	284TC	TSTAT	Y553	284THTNA7026	✓	\$4,216	E3	62.0/31.0	379	27.08	I
	1800	575	284TC	TSTAT	Y567	284THTNA7036	✓	\$4,216	E3	24.8	379	27.08	I
30	1800	230/460	286TC	TSTAT	Y393	286THTNA7026	✓	\$4,754	E3	74.0/37.0	575	28.58	I
	1800	575	286TC	TSTAT	Y394	286THTNA7036	✓	\$4,754	E3	29.6	575	28.58	I

Contact Marathon for other base speeds and options not shown in this catalog.

Blue shaded areas are Cast Iron Frames



Inverter (Vector) Duty: Black Max® Hazardous Duty™ 1000:1 Constant Torque, Explosion Proof, Three Phase Class I and II (gases and dust), Groups C, D, F & G, TENV

Applications:

For use in material handling, machine tools, conveyors, crane & hoist, and other variable speed applications requiring up to 1000:1 constant torque speed range, to be installed in hazardous environments as defined by the motor's explosion proof class and group rating. Refer to the General Information sections contained in this catalog for information on explosion proof classifications. Consult the National Electrical Code and your local regulations for the proper selection of motors in hazardous locations.



Features:

- MAX GUARD® Class F insulation system
- Constant torque operation from 0 to base speed on vector drive
- Constant HP operation to twice base RPM
- Continuous duty at 40°C ambient
- Optimized for operation with IGBT inverter (NEMA Design A)
- Normally closed thermostats (one per phase, Class F)
- Ball Bearings
- Top mount (F3) conduit box included, shipped loose
- No Encoder Provisions provided
- Meets temperature code T3B
- UL listed, under file #E12044
- CSA certified, under file numbers LR47504 and LR21839
- Three year warranty



C-Face Footed (Rigid Base)

HP	RPM	VOLTS	FRAME	OVER LOAD	CAT. NO.	MODEL NO.	STOCK	LIST PRICE	MULT. SYMB.	F.L. AMPS	WEIGHT	"C" DIM.	FOOT NOTES
1/4	1800	230/460	56C	TSTAT	Y600	56H17E5301	✓	\$556	E3	1.1/0.55	26	11.97	
1/3	1800	230/460	56C	TSTAT	Y601	56H17E5302	✓	\$652	E3	1.2/0.6	26	11.97	
1/2	1800	230/460	56C	TSTAT	Y602	56H17E5303	✓	\$703	E3	1.6/0.8	31	12.47	
3/4	1800	230/460	56C	TSTAT	Y603	56H17E5304	✓	\$778	E3	2.4/1.2	38	13.47	
1	1800	230/460	56C	TSTAT	Y604	56H17E5305	✓	\$852	E3	3.0/1.5	43	13.97	

Contact Marathon for other base speeds and options not shown in this catalog.

Inverter (Vector) Duty: Blue Max® 2000 2000:1 Constant Torque, Totally Enclosed, Three Phase

Applications:

Designed for inverter or vector applications where up to a 2000:1 constant torque speed range is required. Typical uses include: material handling, machine tools, conveyors, crane and hoist, metal processing, test stands, pumps, compressors, textile processing, and other industrial machinery installed in dusty or dirty environments where cast iron construction is required.

Features:

- MAX GUARD® Class H insulation system
- Constant torque operation from 0 to base speed on vector drive, including TEFC (On Volts/Hertz drives, TEFC motors are limited to 20:1 constant torque)
- Constant HP operation to twice base speed (143-256 frame); 1.5 times base (all others)
- Optimized for operation with IGBT inverter
- C-Face foot mount through 100 HP, as noted
- Normally closed thermostats (one per phase, class F)
- Continuous duty at 40°C ambient
- 1.0 Service Factor ("B" rise on TEBC motors)
- Blue Chip quality, cast iron frame and brackets
- Patented "fracket" design (TEBC enclosure)
- Ball Bearings (roller bearing available 360 Frame & larger)
- Field reversible to F2
- Encoder provisions included on opposite drive end (see Modification and/or Accessory Kits sections)
- UL Recognized, CSA Certified, and CE Mark
- Three year warranty



Rigid Base and C-Face Footed (Rigid Base)

HP	RPM	VOLTS	ENCL	FRAME	CAT. NO.	MODEL NO.	STOCK	LIST PRICE	MULT. SYMB.	F.L. AMPS	WEIGHT	"C" DIM.	FOOT NOTES
1	1800	230/460	TENV	143TC	Y525	143THTN8028	✓	\$1,003	E3	3.0/1.5	61	13.68	B
1 1/2	1800	230/460	TENV	145TC	Y590	145THTN8037	✓	\$1,008	E3	4.6/2.3	65	14.68	
2	1800	230/460	TENV	145TC	Y526	145THTN8029	✓	\$1,086	E3	6.0/3.0	71	14.68	
3	1800	230/460	TENV	182TC	Y527	182THTS8028	✓	\$1,364	E3	8.0/4.0	113	16.68	
5	1800	230/460	TENV	184TC	Y564	184THTS8028	✓	\$1,525	E3	13.4/6.7	147	17.68	
7 1/2	1800	230/460	TEFC	213TC	Y595	213THFS8028	✓	\$1,784	E3	19.4/9.7	192	21.03	
	1800	230/460	TENV	213TC	Y565	213THTS8038	✓	\$2,055	E3	21.0/10.5	85	20.56	
10	1800	230/460	TEFC	215TC	Y596	215THFS8029	✓	\$2,132	E3	25.4/12.7	212	22.53	
	1800	230/460	TENV	215TC	Y566	215THTS8038	✓	\$2,437	E3	26.0/13.0	272	22.74	
15	1800	230/460	TEFC	254TC	Y597	254THFNA8038	✓	\$2,568	E3	37.0/18.5	350	26.34	
	1800	230/460	TENV	254TC	Y509	254THTNA8058	✓	\$2,917	E3	40.4/20.2	334	23.38	
	1200	230/460	TEBC	284TC	Y395	284THFPA8086		\$5,723	E3	40.0/20.0	500	37.48	BP
20	1800	230/460	TEFC	256TC	Y598	256THFNA8038	✓	\$2,841	E3	52.0/26.0	377	28.09	
	1800	230/460	TENV	256TC	Y510	256THTNA8038	✓	\$4,038	E3	52.0/26.0	425	27.13	
	1200	230/460	TEBC	286TC	Y582	286THFPA8086		\$7,399	E3	52.4/26.2	660	38.98	BP
25	1800	230/460	TEFC	284T	Y569	284THFPA8028	✓	\$3,548	E3	63.0/31.5	393	28.58	
	1800	230/460	TEBC	284TC	Y511	284THFPA8038	✓	\$4,959	E3	63.0/31.5	470	37.48	BP
	1200	230/460	TEBC	324TC	Y583	324THFPA8086		\$8,703	E3	67.0/33.5	633	40.41	B, BP
30	1800	230/460	TEFC	286T	Y570	286THFNA8028	✓	\$4,056	E3	77.0/38.5	371	29.91	
	1800	230/460	TEBC	286TC	Y512	286THFPA8038	✓	\$5,467	E3	74.0/37.0	507	38.98	BP
	1200	230/460	TEBC	326TC	Y584	326THFPA8086		\$9,574	E3	80.4/40.2	550	41.91	B, BP
40	1800	230/460	TEFC	324T	Y571	324THFPA8028	✓	\$5,252	E3	100/50.0	545	30.71	
	1800	230/460	TEBC	324TC	Y513	324THFPA8038	✓	\$6,549	E3	100/50.0	531	40.41	BP
	1200	230/460	TEBC	364TC	Y585	364THFS8391		\$11,549	E3	107/53.5	1011	42.67	BP
50	1800	230/460	TEFC	326T	Y572	326THFS8028	✓	\$6,497	E3	121/60.5	765	32.44	
	1800	230/460	TEBC	326TC	Y514	326THFPA8038	✓	\$7,508	E3	120/60.0	686	41.91	BP
	1200	230/460	TEBC	365TC	Y586	365THFS8380		\$13,845	E3	130/65.0	1081	43.78	BP
60	1800	230/460	TEFC	364T	Y573	364THFS8036	✓	\$8,375	E3	147/73.5	987	33.70	
	1800	230/460	TEBC	364TC	Y515	364THFS8046	✓	\$9,191	E3	147/73.5	1062	42.67	BP
	1200	230/460	TEBC	404TC	Y587	404THFS8092		\$15,358	E3	142/71.0	1339	48.22	BP
75	1800	230/460	TEFC	365T	Y574	365THFS8036	✓	\$9,487	E3	184/92.0	1061	34.69	
	1800	230/460	TEBC	365TC	Y516	365THFS8046	✓	\$10,987	E3	180/90.0	1129	43.67	BP
	1200	230/460	TEBC	405TC	Y588	405THFS8378	✓	\$18,713	E3	180/90.0	1387	49.72	B, BP

Blue shaded areas are Cast Iron Frames

Continued on next page.



Inverter (Vector) Duty: Blue Max® 2000 2000:1 Constant Torque, Totally Enclosed, Three Phase Rigid Base and C-Face Footed (Rigid Base)

HP	RPM	VOLTS	ENCL	FRAME	CAT. NO.	MODEL NO.	STOCK	LIST PRICE	MULT. SYMB.	F.L. AMPS	WEIGHT	"C" DIM.	FOOT NOTES
100	1800	230/460	TEFC	405T	Y575	405THFS8036	✓	\$12,838	E3	230/115	1308	39.32	
	1800	230/460	TEBC	405TC	Y517	405THFS8046	✓	\$15,337	E3	230/115	1529	49.72	BP
	1200	230/460	TEBC	444TC	Y589	444THFN8384	✓	\$21,478	E3	250/125	2117	52.72	BP
125	1800	460	TEFC	444T	Y576	444THFN8036	✓	\$16,896	E3	143	2053	43.27	
	1800	460	TEBC	444T	Y518	444THFN8046	✓	\$19,545	E3	138	2010	52.72	B,BP
150	1800	460	TEFC	445T	Y577	445THFN8036	✓	\$19,507	E3	170	2247	45.27	
	1800	460	TEBC	445T	Y519	445THFN8046	✓	\$22,155	E3	170	2310	54.72	BP
200	1800	460	TEFC	445T	Y578	445THFN8040	✓	\$23,547	E3	230	2388	45.27	
	1800	460	TEBC	445T	Y520	445THFN8050	✓	\$26,195	E3	230	2430	54.72	BP
250	1800	460	TEFC	449T	Y579	449THFS8036	✓	\$29,330	E3	280	2900	53.89	CT
	1800	460	TEBC	449T	Y531	449THFS8046	✓	\$32,811	E3	295	2991	63.21	BP
300	1800	460	TEFC	449T	Y580	449THFS8037	✓	\$33,396	E3	330	3077	53.89	CT
	1800	460	TEBC	449T	Y532	449THFS8047	✓	\$36,876	E3	327	2950	63.21	BP
350	1800	460	TEBC	449T	Y533	449THFS8048	✓	\$40,358	E3	385	3099	63.21	BP

Blue shaded areas are Cast Iron Frames

Inverter (Vector) Duty: Blue Max® 2000 Hazardous Duty™ (with Encoder) 2000:1 Constant Torque, Explosion Proof, Three Phase Class I and II (gases and dust), Groups C (as noted), D, F & G, TENV Applications:

Applications:

Designed for industrial applications with Vector Drives where up to a 2000:1 constant torque speed range and/or precise speed or torque regulation is required, including positioning equipment. Used in dirty, dusty or caustic environments where cast iron construction is required, and installed in hazardous environments as defined by the motor's explosion proof class and group rating. Consult the National Electrical Code and your local regulations for the proper selection of motors in hazardous locations.

Features:

- BEI H38 explosion proof encoder 1024 ppr, Class I Groups C & D, Class II Groups E, F, G included
- MAX GUARD® Class F insulation system
- Constant torque operation from 0 to base speed on vector drive
- Constant HP operation up to twice base speed
- Continuous duty at 40°C ambient
- Optimized for operation with IGBT inverter (NEMA Design A)
- Normally closed thermostats (one per phase, Class F)
- Ball Bearings
- Cast iron frame and brackets
- F1 standard, NOT field reversible to F2
- UL Listed File No. E12044, MC228275
- CSA Certified File No. LR47504, MC236833
- Meets temperature code T3B
- Three year warranty



C-Face Footed (Rigid Base)

HP	RPM	VOLTS	ENCL	FRAME	CAT. NO.	MODEL NO.	STOCK	LIST PRICE	MULT. SYMB.	F.L. AMPS	WEIGHT	"C" DIM.	FOOT NOTES
1	1800	230/460	143TC	TSTAT	Y978	143THEN8034	✓	\$5,810	E3	3.0/1.5	86	21.44	CD
2	1800	230/460	145TC	TSTAT	Y979	145THEN8034	✓	\$5,932	E3	5.8/2.9	90	21.44	CD
3	1800	230/460	182TC	TSTAT	Y980	182THES8048	✓	\$6,123	E3	8.2/4.1	117	24.82	CD
5	1800	230/460	213TC	TSTAT	Y981	213THES8053	✓	\$6,442	E3	13.0/6.5	240	27.42	
7 1/2	1800	230/460	254TC	TSTAT	Y982	254THEN8058	✓	\$7,326	E3	22/11	344	30.20	CD
10	1800	230/460	254TC	TSTAT	Y983	254THEN8059	✓	\$7,675	E3	27.0/13.5	376	30.20	CD
15	1800	230/460	256TC	TSTAT	Y984	256THEN17031	✓	\$8,024	E3	36.0/18.0	432	31.95	CD
20	1800	230/460	284TC	TSTAT	Y985	284THEN8032	✓	\$8,857	E3	53/26.5	555	33.16	CD

Blue shaded areas are Cast Iron Frames

Inverter (Vector) Duty: Blue Max® 2000 Brakemotors 2000:1 Constant Torque, TENV, Three Phase

Applications:

Designed for vector applications where up to a 2000:1 constant torque speed range is required. For use on Conveyors, Machine tools, Cranes, Hoists, and other industrial machinery requiring quick stop and/or holding torque.

Features:

- MAX GUARD® Class F insulation system
- Constant torque operation from 0 to base speed on vector drive
- Constant HP operation to twice base speed
- Optimized for operation with IGBT inverter (NEMA Design A)
- Normally closed thermostats (one per phase, Class F)
- Ball Bearings
- Continuous duty at 40°C ambient
- Will accept encoder through Mod Central (see mod 24 for encoder mounting)
- Includes 140% rated spring-set self-adjusting NEMA 2 disk brake (Brake coil voltage matches motor)
- Horizontal mounting (see comment below and Mod Central for vertical mounting)
- UL Recognized, CSA Certified, and CE Mark
- Three year warranty (brake disks are exempt)



C-Face Footed (Rigid Base)

HP	RPM	VOLTS	FRAME	CAT. NO.	MODEL NO.	STOCK	LIST PRICE	MULT. SYMB.	F.L. AMPS	WEIGHT	"C" DIM.	BRAKE TO. (LB/FT)
1	1800	230/460	143TC	Y986	143THTN8036	√	\$1,813	E3	3.0/1.5	72	17.00	6
2	1800	230/460	145TC	Y987	145THTN8043	√	\$2,019	E3	6.0/3.0	83	18.00	10
3	1800	230/460	182TC	Y988	182THTS8048	√	\$2,644	E3	8.2/4.1	118	19.67	15
5	1800	230/460	184TC	Y989	184THTS8056	√	\$3,187	E3	13.4/6.7	161	25.58	25
7 1/2	1800	230/460	213TC	Y990	213THTS8071	√	\$3,994	E3	21.0/10.5	256	27.58	35
10	1800	230/460	215TC	Y991	215THTS8071	√	\$4,746	E3	26.0/13.0	302	28.83	50
15	1800	230/460	254TC	Y992	254THTNA8071	√	\$6,031	E3	40.5/20.2	384	31.53	75
20	1800	230/460	256TC	Y993	256THTNA8071	√	\$7,994	E3	52.0/26.0	427	33.28	105

Blue shaded areas are Cast Iron Frames

1024 ppr Encoders through MOD Central

Multiplier Symbol E3

BRAND	MODEL	CAT. NO.	KIT NUMBER	STOCK	LIST (LOOSE)	LIST (INSTALLED)	FITS BRAKEMOTOR CAT. NO.	WEIGHT
Avtron	AV56	A748	KIT M561024BRK-140	√	\$2,283	\$2,619	Y986, Y987	4
		A749	KIT M561024BRK-182	√	\$2,283	\$2,619	Y988	4
	M85	A750	KIT M851024BRK-184	√	\$3,080	\$3,416	Y989	5
		A751	KIT M851024BRK-210	√	\$3,080	\$3,416	Y990, Y991	8
		A752	KIT M851024BRK-250	√	\$3,080	\$3,416	Y992, Y993	8
NorthStar	SL56	A786	KIT LKSR-CFACE	√	\$2,510	\$2,846	Y986, Y987	4
		A789	KIT SL561024-182NV	√	\$2,510	\$2,846	Y988	4
	SL85	A790	KIT SL851024-184NV	√	\$3,080	\$3,416	Y989	8
		A791	KIT SL851024-210NV	√	\$3,080	\$3,416	Y990, Y991	8
		A792	KIT SL851024-250NV	√	\$3,080	\$3,416	Y992, Y993	8

Vertical Mounting: 3 HP (182) and lower are suitable for shaft up or down.

5 HP (184) and larger, need vertical modification. Use Cat #: A157, KIT VRT87BRK (SEE MOD SECTION)

CAT. NO.	STOCK	MODEL NO.	LIST KITS ONLY	LIST INSTALLED	WEIGHT
A157	√	KIT VRT87BRK	\$420	\$552	3



DC Permanent Magnet SCR Rated, Totally Enclosed C-Face Footed (Removable Base)

Features:

- Class F insulation
- NEMA C-Face with removable rigid base
- Oversized brushes for extra long life
- Permanently lubricated sealed ball bearings
- Linear speed/torque characteristics over entire speed range
- High starting torque, high peak current capability
- Usable on PWM type DC adjustable speed drives at higher HP rating
- Easy brush access with unique brush holder design
- UL Recognized and CSA Certified



HP	RPM	DC VOLTS	FRAME	ENCL.	CAT. NO.	MODEL NO.	STOCK	LIST PRICE	MULT. SYMB.	C.T. SPEED RANGE	F.L. AMPS	PWM HP RATING	WEIGHT	"C" DIM.	FOOT NOTES
1/4	1750	90	56C	TEFC	Z602	56E17F1001	√	\$498	D1	2:1	2.5	0.40	22	10.81	
	1750	180	56C	TEFC	Z603	56E17F1002	√	\$498	D1	2:1	1.4	0.50	22	11.31	
1/3	1750	90	56C	TEFC	Z604	56E17F1003	√	\$528	D1	2:1	3.5	0.50	24	11.31	
	1750	180	56C	TEFC	Z605	56E17F1004	√	\$528	D1	2:1	1.7	0.50	22	11.31	
1/2	1750	90	56C	TEFC	Z606	56E17F1005	√	\$588	D1	2:1	5.0	0.70	26	11.81	
	1750	180	56C	TEFC	Z607	56E17F1006	√	\$588	D1	2:1	2.5	0.56	25	11.81	
3/4	1750	90	56C	TEFC	Z610	56E17F1007	√	\$714	D1	2:1	7.6	1.00	34	13.81	
	1750	180	56C	TEFC	Z611	56E17F1008	√	\$714	D1	2:1	3.8	1.00	34	13.81	
1	1750	90	56C	TEFC	Z612	56E17F2005	√	\$872	D1	2:1	10.0	1.25	45	14.81	
	1750	180	56C	TEFC	Z613	56E17F2006	√	\$872	D1	2:1	5.0	1.25	41	14.81	
1 1/2	1750	180	56C	TEFC	Z614	56E17F2007	√	\$1,090	D1	2:1	7.6	1.75	52	16.81	
	1750	180	145TC	TEFC	Z615	145TEFR5326	√	\$1,656	D1	2:1	7.5	1.50	74	18.34	
2	1750	180	145TC	TEFC	Z616	145TEFR5327	√	\$1,975	D1	2:1	9.5	2.00	86	19.34	
	1750	180	182/145TC	TEFC	Z617	182TEFR5326	√	\$1,975	D1	2:1	9.5	2.00	83	19.34	84



SCR PMDC motors on PWM power supplies

Pulse width modulated DC controls have a voltage output similar to pure direct current which has a form factor of 1.05. SCR thyristor drives have a form factor of 1.40. Marathon Electric's non-Explosion Proof PMDC, SCR-rated motors can also be used with PWM controls, and due to the lower form factor and the resultant lower heating in the motor, their rating can be increased as indicated above. Operation on PWM controls will also result in quieter operation and longer brush life.

Washdown, DC Permanent Magnet SCR Rated, Totally Enclosed C-Face Footed (Removable Base)

Features:

- Class F insulation
- NEMA C-Face with removable rigid base
- Oversized brushes for extra long life
- Doubled sealed, oversized ball bearings
- Corrosion resistant 303 stainless steel shaft
- “V” ring Forsheda seals
- High temperature, moisture resistant lubricant
- Exterior and interior components protected with enamel & polyester compounds
- Aluminum conduit box, threaded and gasketed
- Drains at 3:00, 6:00, 9:00 and 12:00 locations
- Sealed machine fits
- Stainless steel nameplate
- USDA approved white epoxy paint
- UL Recognized and CSA Certified



HP	RPM	DC VOLTS	FRAME	ENCL.	CAT. NO.	MODEL NO.	STOCK	LIST PRICE	MULT. SYMB.	C.T. SPEED RANGE	F.L. AMPS	PWM HP RATING	WEIGHT	“C” DIM.	FOOT NOTES
1/4	1750	90	56C	TENV	Z630	56E17V2001	√	\$639	D1	20:1	2.7	0.30	24	10.69	
1/3	1750	90	56C	TENV	Z631	56E17V2002		\$676	D1	20:1	3.5	0.56	30	11.69	
1/2	1750	90	56C	TENV	Z634	56E17V2003	√	\$757	D1	20:1	4.9	0.75	37	13.69	
		180	56C	TENV	Z635	56E17V2004	√	\$757	D1	20:1	2.4	0.70	41	13.69	
3/4	1750	90	56C	TENV	Z636	56E17V2005	√	\$918	D1	20:1	7.0	1.25	51	14.67	
		180	56C	TENV	Z637	56E17V2006		\$918	D1	20:1	3.5	1.25	50	14.17	
1	1750	90	56C	TEFC	Z638	56E17W2001	√	\$1,120	D1	2:1	10.0	1.25	45	14.81	
		180	56C	TEFC	Z639	56E17W2002	√	\$1,120	D1	2:1	5.0	1.25	41	14.81	
1 1/2	1750	180	56C	TEFC	Z641	56E17W2003		\$1,430	D1	2:1	7.6	1.75	51	16.81	

Low Voltage, DC Permanent Magnet TENV and TEFC C-Face Footed (Removable Base)

Features:

- Permanently lubricated sealed ball bearings
- NEMA C-Face with removable base
- Class H insulation
- Easy brush access with unique brush holder design
- Oversized brushes for extra long life
- High starting torque
- U.L. Recognized and CSA Certified

Applications

Low voltage permanent magnet DC motors are suitable for installations having batteries or generator supplied low voltage DC.



HP	RPM	DC VOLTS	FRAME	ENCL.	CAT. NO.	MODEL NO.	STOCK	LIST PRICE	MULT. SYMB.	F.L. AMPS	WEIGHT	“C” DIM.	FOOT NOTES
1/4	1750	12	56C	TENV	Z660	56E17T2001	√	\$535	D1	21.0	22	10.27	85
1/3	1750	12	56C	TENV	Z662	56E17T2002	√	\$589	D1	27.0	24	10.77	d,85
		24	56C	TENV	Z663	56E17T2003	√	\$563	D1	13.5	23	10.77	85
1/2	1750	12	56C	TENV	Z664	56E17T2004	√	\$612	D1	39.0	30	11.77	85
		24	56C	TENV	Z665	56E17T2005	√	\$585	D1	20.0	28	11.77	d,85
3/4	1750	12	56C	TEFC	Z666	56E17F2008	√	\$676	D1	58.0	35	13.81	85
		24	56C	TEFC	Z667	56E17F2009	√	\$611	D1	29.0	32	12.81	85
1	1750	12	56C	TEFC	Z668	56E17F2010	√	\$805	D1	80.0	39	13.81	
		24	56C	TEFC	Z669	56E17F2011	√	\$742	D1	39.0	34	13.81	85



Globetrotter® IEC (Metric) Frame, Three Phase

Totally Enclosed, B3 Mounting, Rigid Base

Applications:

For use on fans, pumps, compressors, conveyors, and other equipment requiring IEC dimensions and electrical standards. The Globetrotter is not only designed to International standards but meets NEMA performance and efficiency standards making it suitable for requirements worldwide.

Features:

- Meets IE3 European and NEMA Premium® efficiencies
- Aluminum (63-90 frame) or Cast Iron (100-250 frame) construction
- Nameplated 60/50 hertz at same HP (except as noted)
- MX GUARD® Class F Insulation, Class B rise @ rated KW
- IP55 weatherproof enclosure
- Rotatable/Removable Base (63-90 frame)
- Wye Start-Delta Run on 160 Frame and larger
- 10:1 Variable Torque, Constant Torque speed range as noted
- Top Mounted/Oversized gasketed terminal box
- Meets IEEE45, IEC60092 & USCG CFR46 Marine Duty (63-90 frame "Below Deck")
- 1.15 Service Factor on 60 Hz sine wave, 1.0 SF or VFD
- IEC Design "N" with NEMA "B" Torques



IP55



- Terminal Blocks, Stud Type, Zero Creepage
- Kits or MOD Central for B3/B14 mounting, see Accessories section
- Meets IEC 34 electrical standards
- Meets IEC 72 dimensions and tolerances
- CE Marked
- 1 Year Warranty

CONSULT
MARATHON
ELECTRIC FOR
SPECIAL IEC
MOTORS

Multiplier Symbol F4

Suitable for use on VFD per guidelines on page 17.

HP/ kW	RPM 60/50 HZ	60 HZ VOLTS	50 HZ VOLTS	IEC FRAME	CAT. NO.	MODEL NO.	STOCK	C.T. SPEED RANGE*	LIST PRICE	NOM. EFF.	60 HZ F.L. AMPS	WEIGHT	IEC "L" DIM. (MM)	FOOT NOTES	B5/FF FLANGE
1/4-.18	3600/3000	230/460	200/400	63	R300	63T34FH5301	√	20:1	\$187	72.0	0.8/0.4	11	217		A569
	3600/3000	575	480	63	R400	63T34FH5303	√	20:1	\$187	72.0	0.3	11	217		A569
	1800/1500	230/460	200/400	63	R301	63T17FH5326	√	20:1	\$195	68.0	1.0/0.5	12	217		A569
	1800/1500	575	480	63	R401	63T17FH5327	√	20:1	\$195	68.0	0.4	12	217		A569
	1200/1000	230/460	200/400	71	R302	71T11FH5376	√	20:1	\$332	64.0	1.2/0.6	13	240		A570
1/3-.25	3600/3000	230/460	200/400	63	R303	63T34FH5302	√	20:1	\$219	72.0	1.1/55	12	217		A569
	3600/3000	575	480	63	R403	63T34FH5304	√	20:1	\$219	72.0	0.4	12	217		A569
	1800/1500	230/460	200/400	71	R304	71T17FH5326	√	20:1	\$228	68.0	1.4/7	14	240		A570
	1800/1500	575	480	71	R404	71T17FH5330	√	20:1	\$228	68.0	0.6	14	240		A570
	1200/1000	230/460	200/400	80	R305	80T11FH5376	√	20:1	\$357	70.0	1.3/65	20	282		A571
1/2-.37	3600/3000	230/460	200/400	71	R306	71T34FH5301	√	20:1	\$233	74.0	1.6/8	14	240		A570
	3600/3000	575	480	71	R406	71T34FH5033	√	20:1	\$233	74.0	0.7	14	240		A570
	1800/1500	230/460	200/400	71	R307	71T17FH5327	√	20:1	\$237	74.0	1.8/9	15	240		A570
	1800/1500	575	480	71	R407	71T17FH5331	√	20:1	\$237	74.0	0.7	16	240		A570
	1200/1000	230/460	200/400	80	R308	80T11FH5377	√	20:1	\$372	72.0	1.9/95	22	282		A571
3/4-.55	3600/3000	230/460	200/400	71	R309	71T34FH5302	√	20:1	\$245	74.0	2.4/1.2	16	240		A570
	3600/3000	575	480	71	R409	71T34FH5304	√	20:1	\$245	74.0	0.9	16	240		A570
	1800/1500	230/460	200/400	80	R310	80T17FH5326	√	20:1	\$258	74.0	2.5/1.25	21	282		A571
	1800/1500	575	480	80	R410	80T17FH5330	√	20:1	\$258	74.0	1.0	22	282		A571
	1200/1000	230/460	200/400	80	R311	80T11FH5378	√	20:1	\$400	72.0	2.7/1.35	25	282		A571
1-.75	3600/3000	230/460	200/400	80	R312	80T34FH5301	√	20:1	\$278	75.5	2.8/1.4	24	282		A571
	3600/3000	575	480	80	R412	80T34FH5305	√	20:1	\$278	75.5	1.1	24	282		A571
	1800/1500	230/460	200/400	80	R313	80T17FH5327	√	20:1	\$282	80.0	3.2/1.6	29	282		A571
	1800/1500	575	480	80	R413	80T17FH5331	√	20:1	\$282	80.0	1.4	28	282		A571
	1200/1000	230/460	200/400	90S	R314A	90ST11FH6376	√	20:1	\$486	82.5	3.3/1.7	36	326		A572
1 1/2-1.1	3600/3000	230/460	200/400	80	R315	80T34FH5302	√	20:1	\$287	84.0	4.0/2.0	30	282		A571
	3600/3000	575	480	80	R415	80T34FH5303	√	20:1	\$287	84.0	1.6	29	282		A571
	1800/1500	230/460	200/400	90S	R316A	90ST17FH6326	√	20:1	\$369	86.5	4.6/2.3	44	326		A572
	1800/1500	575	480	90S	R416A	90ST17FH6327	√	20:1	\$369	86.5	1.8	43	326		A572
	1200/1000	230/460	200/400	100L	R317	100LTFC6586	√	2:1	\$576	87.5	5.5/10	82	380		A554A
2-1.5	3600/3000	230/460	200/400	90S	R318A	90ST34FH6301	√	20:1	\$384	85.5	5.2/2.6	39	326		A572
	3600/3000	575	480	90S	R418A	90ST34FH6302	√	20:1	\$384	85.5	2.1	39	326		A572
	1800/1500	230/460	200/400	90L	R319A	90LT17FH6326	√	20:1	\$396	86.5	5.8/2.9	45	326		A572
	1800/1500	575	480	90L	R419A	90LT17FH6327	√	20:1	\$396	86.5	2.4	32	326		A572
	1200/1000	230/460	200/400	100L	R320A	100LTFC6576	√	2:1	\$619	88.5	7.6/3.8	90	380		A554A

Catalog numbers (Cat No.) highlighted in bold blue have efficiency levels that meet EISA requirements

Blue shaded areas are Cast Iron Frames

* Requires nameplate modification

Continued on next page.

Globetrotter® IEC (Metric) Frame, Three Phase Totally Enclosed, B3 Mounting, Rigid Base

Multiplier Symbol F4

HP/ kW	RPM 60/50 HZ	60 HZ VOLTS	50 HZ VOLTS	IEC FRAME	CAT. NO.	MODEL NO.	STOCK	C.T. SPEED RANGE*	LIST PRICE	NOM. EFF.	60 HZ F.L. AMPS	WEIGHT	IEC "L" DIM. (MM)	FOOT NOTES	B5/FF FLANGE	
3-2.2	3600/3000	230/460	200/400	90L	R321A	90LT34FH6301	✓	20:1	\$553	86.5	7.2/3.6	42	326	68	A572	
	3600/3000	575	480	90L	R421A	90LT34FH6302	✓	20:1	\$553	86.5	2.9	42	326	68	A572	
4-3	1800/1500	230/460	200/400	100L	R322A	100LTFC6526	✓	20:1	\$600	89.5	9.0/4.5	84	415	68	A554A	
	1800/1500	575	480	100L	R422A	100LTFC6527	✓	20:1	\$600	89.5	3.6	84	415	68	A554A	
	1200/1000	230/460	200/400	112M	R323A	112MTFC6576	✓	20:1	\$874	89.5	9.0/4.5	100	470	68	A554A	
	3600/3000	230/460	200/400	100L	R351A	100LTFC6501	✓	20:1	\$640	87.5	9.2/4.6	71	415	68	A554A	
4-3	3600/3000	575	480	100L	R451A	100LTFC6502	✓	20:1	\$640	87.5	3.7	71	415	68	A554A	
	1800/1500	230/460	200/400	100L	R352A	100LTFC6536	✓	20:1	\$651	89.5	11.0/5.5	84	415	68	A554A	
	1800/1500	575	480	100L	R452A	100LTFC6537	✓	20:1	\$651	89.5	4.4	84	415	68	A554A	
	1200/1000	230/460	200/400	132S	R353A	132STFC6586	✓	2:1	\$1,058	89.5	13.0/6.5	154	464	68	A556A	
	5 1/2-4	3600/3000	230/460	200/400	112M	R324A	112MTFC6511	✓	20:1	\$824	87.5	12.8/6.4	104	410	68	A555B
		3600/3000	575	480	112M	R424A	112MTFC6512	✓	20:1	\$824	87.5	5.1	104	410	68	A555B
1800/1500		230/460	200/400	112M	R325A	112MTFC6536	✓	20:1	\$794	89.5	14.0/7.0	104	410	68	A555B	
1800/1500		575	480	112M	R425A	112MTFC6537	✓	20:1	\$794	89.5	5.6	104	410	68	A555B	
1200/1000		230/460	200/400	132M	R326A	132MTFC6586	✓	2:1	\$1,221	89.5	17/8.5	176	502	68	A556A	
7 1/2-5.5	3600/3000	230/460	200/400	132S	R327A	132STFC6501	✓	20:1	\$1,033	90.2	17.6/8.8	152	464	68	A550	
	3600/3000	575	480	132S	R427A	132STFC6503	✓	20:1	\$1,033	90.2	7.0	152	464	68	A550	
	1800/1500	230/460	200/400	132S	R328A	132STFC6526	✓	20:1	\$998	91.7	19.6/9.8	150	464	68	A556A	
	1800/1500	575	480	132S	R428A	132STFC6527	✓	20:1	\$998	91.7	7.8	105	464	68	A556A	
	1200/1000	230/460	200/400	132M	R329A	132MTFC6587	✓	2:1	\$1,469	91.0	23.4/11.7	180	502	68	A556A	
10-7.5	3600/3000	230/460	200/400	132S	R330A	132STFC6502	✓	20:1	\$1,105	90.2	23.2/11.6	163	464	68	A550	
	3600/3000	575	480	132S	R430A	132STFC6504	✓	20:1	\$1,105	90.2	9.3	163	464	68	A550	
	1800/1500	230/460	200/400	132M	R331A	132MTFC6536	✓	2:1	\$1,225	91.7	26.0/13.0	174	502	68	A556A	
	1800/1500	575	480	132M	R431A	132MTFC6537	✓	2:1	\$1,225	91.7	10.4	174	502	68	A556A	
	1200/1000	230/460	200/400	160M	R332A	160MTFC6586	✓	2:1	\$1,905	91.0	28.0/14.0	251	615	YD, 68	A557	
15-11	3600/3000	230/460	200/400	160M	R333A	160MTFC6511	✓	2:1	\$1,790	91.7	35.2/17.6	260	600	YD, 68	A551	
	1800/1500	230/460	200/400	160M	R334A	160MTFC6536	✓	10:1	\$1,756	92.4	37.8/18.9	264	600	YD, 68	A557	
	1200/1000	230/460	200/400	160L	R335A	160LTFC6588	✓	2:1	\$2,445	91.7	38.8/19.4	330	675	YD, 68	A557	
20-15	3600/3000	230/460	200/400	160M	R336A	160MTFC6512	✓	10:1	\$2,100	91.7	46.8/23.4	269	600	YD, 68	A551	
	1800/1500	230/460	200/400	160L	R337A	160LTFC6538	✓	2:1	\$2,214	93.0	47.0/23.5	311	600	YD, 68	A557	
	1200/1000	230/460	200/400	180L	R338A	180LTFC6588	✓	2:1	\$3,429	91.7	54.0/27.0	385	718	YD, 68	A558	
25-18.5	3600/3000	230/460	200/400	160L	R339A	160LTFC6513	✓	2:1	\$2,556	91.7	57.6/28.8	319	645	YD, 68	A551	
	1800/1500	230/460	200/400	180M	R340A	180MTFC6536	✓	20:1	\$2,814	93.6	59.2/29.6	381	680	YD, 68	A558	
	1200/1000	230/460	200/400	200L	R341A	200LTFC6588	✓	2:1	\$4,300	93.0	63.0/31.5	467	775	YD, 68	A559	
30-22	3600/3000	230/460	200/400	180M	R342A	180MTFC6511	✓	2:1	\$3,038	92.4	68.8/34.4	355	680	YD, 68	A552	
	1800/1500	230/460	200/400	180L	R343A	180LTFC6538	✓	20:1	\$3,163	93.6	69.2/34.6	427	718	YD, 68	A558	
	1200/1000	230/460	200/400	200L	R344A	200LTFC6589	✓	2:1	\$4,871	93.0	76/38	467	750	YD, 68	A559	
40-30	3600/3000	230/460	200/400	200L	R345A	200LTFC6511	✓	20:1	\$4,325	92.4	89.6/44.8	522	750	YD, 68	A553	
	1800/1500	230/460	200/400	200L	R346A	200LTFC6538	✓	2:1	\$4,656	94.1	95/47.5	531	750	YD, 68	A559	
	1200/1000	230/460	200/400	225M	R347A	225MTFC6586	✓	2:1	\$7,319	94.1	100/50	633	837	YD, 68	A580	
50-37	3600/3000	230/460	200/400	200L	R348A	200LTFC6513	✓	10:1	\$5,673	93.0	111.4/55.7	546	750	YD, 68	A553	
	1800/1500	230/460	200/400	225S	R349A	225STFC6526	✓	10:1	\$6,460	94.5	117.6/58.8	632	812	YD, 68	A580	
	1200/1000	230/460	200/400	250M	R350A	250MTFC6586	✓	2:1	\$10,259	94.1	125/62.5	655	1350	YD, 68	A594	
60-45	3600/3000	230/460	200/400	225M	R500	225MTFC6501	✓	10:1	\$8,794	93.6	136/68.0	590	837	YD, 68	A580	
	1800/1500	230/460	200/400	225M	R501	225MTFC6526	✓	10:1	\$9,708	95.0	140/70.0	1005	837	YD, 68	A580	
	1200/1000	230/460	200/400	280S	R502	280STFC6586	✓	2:1	\$12,954	94.5	146/73.0	975		YD, 68	A596	
75-55	3600/3000	230/460	200/400	250M	R503	250MTFC6501	✓	2:1	\$12,069	93.6	170/85.0	937	1350	YD, 68	A594	
	1800/1500	230/460	200/400	250M	R504	250MTFC6526	✓	2:1	\$11,361	95.4	174/87.0	1030	1350	YD, 68	A594	
	1200/1000	230/460	200/400	280M	R505	280MTFC6588	✓	2:1	\$14,278	94.5	180/90.0	1100		YD, 68	A596	
100-75	3600/3000	230/460	200/400	280S	R506	280STFC6501	✓	2:1	\$14,435	94.1	224/112	1016		YD, 68	A596	
	1800/1500	230/460	200/400	280S	R507	280STFC6526	✓	2:1	\$13,118	95.4	226/113	1025		YD, 68	A596	
	1200/1000	230/460	200/400	315S	R508	315STFC6588	✓	2:1	\$17,882	95.0	234/117	1300		YD, 68	A598	

Catalog numbers (Cat No.) highlighted in bold blue have efficiency levels that meet EISA requirements

Blue shaded areas are Cast Iron Frames

* Requires nameplate modification

Continued on next page.



Globetrotter® IEC (Metric) Frame, Three Phase Totally Enclosed, Flange/Base Mounting



B3/B5 "FF" (D-Flange)

Multiplier Symbol F4

HP/ kW	RPM 60/50 HZ	60 HZ VOLTS	50 HZ VOLTS	IEC FRAME	CAT. NO.	MODEL NO.	STOCK	C.T. SPEED RANGE*	LIST PRICE	NOM. EFF.	60 HZ F.L. AMPS	WEIGHT	IEC "L" DIM. (MM)	FOOT NOTES
1/4-.18	3600/3000	230/460	200/400	63D	R380	63T34FH5501	✓	20:1	\$215	72.0	0.8/0.4	10	217	
	1800/1500	230/460	200/400	63D	R381	63T17FH5502	✓	20:1	\$222	68.0	1.0/0.5	11	217	
	1200/1000	230/460	200/400	71D	R382	71T11FH5503	✓	20:1	\$382	64.0	1.2/0.6	12	240	
1/3-.25	3600/3000	230/460	200/400	63D	R383	63T34FH5504	✓	20:1	\$249	72.0	1.1/.55	11	217	
	1800/1500	230/460	200/400	71D	R384	71T17FH5505	✓	20:1	\$257	68.0	1.4/.7	13	240	
	1200/1000	230/460	200/400	80D	R385	80T11FH5506	✓	20:1	\$410	70.0	1.3/.65	17	282	
1/2-.37	3600/3000	230/460	200/400	71D	R386	71T34FH5507	✓	20:1	\$255	74.0	1.6/.8	13	240	
	1800/1500	230/460	200/400	71D	R387	71T17FH5508	✓	20:1	\$264	74.0	1.8/.9	14	282	
	1200/1000	230/460	200/400	80D	R388	80T11FH5509	✓	20:1	\$427	72.0	1.9/.95	19	282	
3/4-.55	3600/3000	230/460	200/400	71D	R389	71T34FH5510	✓	20:1	\$270	74.0	2.4/1.2	15	282	
	1800/1500	230/460	200/400	80D	R390	80T17FH5511	✓	20:1	\$288	74.0	2.5/1.25	18	282	
	1200/1000	230/460	200/400	80D	R391	80T11FH5512	✓	20:1	\$452	72.0	2.7/1.35	22	320	
1-.75	3600/3000	230/460	200/400	80D	R392	80T34FH5513	✓	20:1	\$297	75.5	2.8/1.4	21	282	
	1800/1500	230/460	200/400	80D	R393	80T17FH5514	✓	20:1	\$311	80.0	3.2/1.6	26	282	
	1200/1000	230/460	200/400	90SD	R394A	90ST11FH6515	✓	20:1	\$556	82.5	3.3/1.7	35	320	68
1 1/2-1.1	3600/3000	230/460	200/400	80D	R395	80T34FH5516	✓	20:1	\$339	84.0	4.0/2.0	30	282	
	1800/1500	230/460	200/400	90SD	R396A	90ST17FH6517	✓	20:1	\$403	86.5	4.6/2.3	37	320	68
2-1.5	3600/3000	230/460	200/400	90SD	R397A	90ST34FH6518	✓	20:1	\$439	85.5	5.2/2.6	33	320	68
	1800/1500	230/460	200/400	90LD	R398A	90LT17FH6519	✓	20:1	\$451	86.5	5.8/2.9	38	320	68
3-2.2	3600/3000	230/460	200/400	90LD	R399A	90LT34FH6520	✓	20:1	\$621	86.5	7.2/3.6	39	320	68



B3/B14 "FT" (C-Face)

HP/ kW	RPM 60/50 HZ	60 HZ VOLTS	50 HZ VOLTS	IEC FRAME	CAT. NO.	MODEL NO.	STOCK	C.T. SPEED RANGE*	LIST PRICE	NOM. EFF.	60 HZ F.L. AMPS	WEIGHT	IEC "L" DIM. (MM)	FOOT NOTES
1/4-.18	3600/3000	230/460	200/400	63C	R360	63T34FH5401	✓	20:1	\$211	72.0	0.8/0.4	10	217	
	1800/1500	230/460	200/400	63C	R361	63T17FH5402	✓	20:1	\$219	68.0	1.0/0.5	11	217	
	1200/1000	230/460	200/400	71C	R362	71T11FH5403	✓	20:1	\$382	64.0	1.2/0.6	12	240	
1/3-.25	3600/3000	230/460	200/400	63C	R363	63T34FH5404	✓	20:1	\$247	72.0	1.1/.55	11	217	
	1800/1500	230/460	200/400	71C	R364	71T17FH5405	✓	20:1	\$250	68.0	1.4/.7	13	240	
	1200/1000	230/460	200/400	80C	R365	80T11FH5406	✓	20:1	\$410	70.0	1.3/.65	17	282	
1/2-.37	3600/3000	230/460	200/400	71C	R366	71T34FH5407	✓	20:1	\$251	74.0	1.6/.8	13	240	
	1800/1500	230/460	200/400	71C	R367	71T17FH5408	✓	20:1	\$261	74.0	1.8/.9	14	282	
	1200/1000	230/460	200/400	80C	R368	80T11FH5409	✓	20:1	\$427	72.0	1.9/.95	19	282	
3/4-.55	3600/3000	230/460	200/400	71C	R369	71T34FH5410	✓	20:1	\$264	74.0	2.4/1.2	15	282	
	1800/1500	230/460	200/400	80C	R370	80T17FH5411	✓	20:1	\$283	74.0	2.5/1.25	18	282	
	1200/1000	230/460	200/400	80C	R371	80T11FH5412	✓	20:1	\$452	72.0	2.7/1.35	22	320	
1-.75	3600/3000	230/460	200/400	80C	R372	80T34FH5413	✓	20:1	\$291	75.5	2.8/1.4	21	282	
	1800/1500	230/460	200/400	80C	R373	80T17FH5414	✓	20:1	\$304	80.0	3.2/1.6	26	282	
	1200/1000	230/460	200/400	90SC	R374A	90ST11FH6415	✓	20:1	\$556	82.5	3.3/1.7	35	320	68
1 1/2-1.1	3600/3000	230/460	200/400	80C	R375	80T34FH5416	✓	20:1	\$331	84.0	4.0/2.0	30	282	
	1800/1500	230/460	200/400	90SC	R376A	90ST17FH6417	✓	20:1	\$395	86.5	4.6/2.3	37	320	68
2-1.5	3600/3000	230/460	200/400	90SC	R377A	90ST34FH6418	✓	20:1	\$430	85.5	5.2/2.6	33	320	68
	1800/1500	230/460	200/400	90LC	R378A	90LT17FH6419	✓	20:1	\$439	86.5	5.8/2.9	38	320	68
3-2.2	3600/3000	230/460	200/400	90LC	R379A	90LT34FH6420	✓	20:1	\$621	86.5	7.2/3.6	39	320	68

Catalog numbers (Cat No.) highlighted in bold blue have efficiency levels that meet EISA requirements

* Requires nameplate modification

Brake Motors, Single Phase

Totally Enclosed, C-Face Footed (Removable Base)

Features:

- Fail-safe, spring set Stearns brake for holding or stopping
- Brake has manual wear adjustment for longer pad life
- Manual release lever on rear of brake housing
- Brake leads are terminated at the brake
- Vertical or horizontal mounting
- Brake coil voltage matches motor voltages, see mod section for other brake coils
- Ball bearings, mechanically locked on shaft end
- 1.15 Service Factor (1.0 Service Factor as noted)
- Nameplated 60/50 hertz at next lowest horsepower
- UL Recognized and CSA Certified



HP	RPM	VOLTS	FRAME	CAT. NO.	MODEL NO.	STOCK	LIST PRICE	MULT. SYMB.	F.L. AMPS	WEIGHT	"C" DIM.	BRAKE RATING	FOOT NOTES
1/3	1800	115/208-230	56C	D400	56C17F5352	✓	\$641	E5	6.6/3.1-3.3	33	16.20	3	2,6
1/2	1800	115/208-230	56C	D401	56C17F5353	✓	\$707	E5	8.8/4.2-4.4	34	16.20	3	2,6
3/4	1800	115/208-230	56C	D402	56C17F5354	✓	\$916	E5	11.0/5.4-5.5	38	16.70	6	2,6
1	1800	115/208-230	56C	D403	56C17F5355	✓	\$974	E5	13.4/6.8-6.7	40	17.20	6	2,6
1 1/2	1800	115/208-230	56C	D404	56B17F5330	✓	\$1,028	E5	15.2/8.2-7.6	50	19.04	10	1,6

Brake Motors, Three Phase

Totally Enclosed

Features:

- In addition to the Single Phase Features above:
- Brake has manual wear adjustment up to 25 lb-ft. for longer pad life
- Brake leads routed through motor conduit box (TENV only)
- Vertical or horizontal mounting up to 15 lb-ft, see mod section for larger brakes
- CR200 Corona resistant magnet wire (motor can be operated 10:1 variable torque)



Rigid Base

HP	RPM	VOLTS	FRAME	CAT. NO.	MODEL NO.	STOCK	LIST PRICE	MULT. SYMB.	F.L. AMPS	WEIGHT	"C" DIM.	BRAKE RATING	FOOT NOTES
1/2	1800	230/460	56	K456	5K49KN4573	✓	\$820	E5	1.8/0.9	31	14.06	3	17,N
	1200	230/460	56	K526	5K49MN6369	✓	\$1,131	E5	2.4/1.2	33	15.56	3	17,N
3/4	1800	230/460	56	K458	5K49PN4564	✓	\$1,014	E5	2.5/1.25	36	14.56	6	17,N
1	1800	230/460	56	K459	5K49UN4569	✓	\$1,173	E5	3.2/1.6	45	15.56	6	17,N
	1800	230/460	143T	K461	5K49UN4566	✓	\$1,173	E5	3.2/1.6	47	16.00	6	17,N
2	1800	230/460	145T	K2045	5KE49WN4571	✓	\$1,213	E5	5.6/2.8	44	18.00	10	17



C-Face Footless

HP	RPM	VOLTS	FRAME	CAT. NO.	MODEL NO.	STOCK	LIST PRICE	MULT. SYMB.	F.L. AMPS	WEIGHT	"C" DIM.	BRAKE RATING	FOOT NOTES
1/2	1800	230/460	56C	K457	5K49KN4563	✓	\$678	E5	1.8/0.9	31	14.06	3	N,17
3/4	1800	230/460	56C	K460	5K49PN4565	✓	\$797	E5	2.5/1.25	37	14.56	6	N,17
1	1800	230/460	143TC	K462	5K49UN4567	✓	\$1,192	E5	3.2/1.6	46	16.00	6	N,17
1 1/2	1800	208-230/460	56C	K1494	5K49RN4570	✓	\$1,050	E5	5.0/2.5	40	16.56	10	17
2	1800	230/460	145TC	K2046	5KE49WN4572	✓	\$1,103	E5	5.6/2.8	44	18.00	10	17

Continued on next page.

Brake Motors, Three Phase

C-Face Footed, C-Face Footed (Removable Base)

Features:

- In addition to the Single Phase Features on previous page:
- Brake has manual wear adjustment up to 25 lb-ft. for longer pad life
- Brake leads routed through motor conduit box (TENV only)
- Vertical or horizontal mounting up to 15 lb-ft, see mod section for larger brakes
- CR200 Corona resistant magnet wire (motor can be operated 10:1 variable torque and 2:1 constant torque)
- 1.15 Service Factor, 1.0 Service Factor where footnoted



BRAKE MOTORS

HP	RPM	VOLTS	FRAME	CAT. NO.	MODEL NO.	STOCK	LIST PRICE	MULT. SYMB.	F.L. AMPS	WEIGHT	"C" DIM.	BRAKE RATING	FOOT NOTES
1/3	1800	208-230/460	56C	D450	56T17F5348	√	\$603	E5	1.8-1.6/0.8	30	15.73	3	6
	1200	208-230/460	56C	D451	56T11F5325	√	\$799	E5	1.9-2.2/1.1	30	15.73	3	6
1/2	1800	208-230/460	56C	D452	56T17F5349	√	\$678	E5	2.3-2.4/1.2	32	16.23	3	6
	1200	208-230/460	56C	D453	56T11F5326	√	\$997	E5	2.4-2.7/1.4	33	16.23	6	6
3/4	1800	208-230/460	56C	D454	56T17F5350	√	\$797	E5	2.9-3.0/1.5	33	16.23	6	6
	1200	208-230/460	56C	D455	56T11F5327	√	\$1,171	E5	3.1-3.2/1.6	37	16.73	6	6
1	1800	208-230/460	56C	D456	56T17F5357	√	\$946	E5	3.5-3.6/1.8	35	16.73	6	6
	1200	208-230/460	145TC	C400	145TTFR5382	√	\$1,255	E5	3.95-4.0/2.0	48	17.26	10	6
1 1/2	1800	208-230/460	56HC	D457	56T17F5358	√	\$1,050	E5	4.8-4.8/2.4	38	17.26	10	6
	1800	208-230/460	145TC	C401	145TTFR5360	√	\$1,050	E5	4.8-4.8/2.4	40	16.76	10	6
	1200	208-230/460	184TC	C402	184TTTL7084	√	\$1,399	E5	5.55-5.2/2.6	130	19.23	15	AL,F,N,82
2	1800	208-230/460	145TC	C403	145TTFR5359	√	\$1,103	E5	6.0-5.8/2.9	49	18.77	10	6
	1200	208-230/460	184TC	C404	184TTTL7083	√	\$1,460	E5	6.8-6.6/3.3	90	19.23	15	AL,F,N,82
3	1800	230/460	182TC	C405	182TTTL7034	√	\$1,460	E5	8.0/4.0	100	19.68	15	AL,F,N,82
5	1800	208-230/460	184TC	C406	184TTTL7041	√	\$1,974	E5	13.8-12.4/6.2	115	20.68	25	AL,F,N,17,82
7 1/2	1800	230/460	213TC	C407	213TTTL7034	√	\$2,592	E5	19.2/9.6	176	27.04	35	AL,N,17,82
10	1800	230/460	215TC	C408	215TTTL7050	√	\$3,240	E5	25.0/12.5	211	28.64	50	AL,N,17,82

Farm Duty / Agriculture, High Torque

Single Phase, TEFC

Features:

- Ball bearings, shaft end mechanically locked on C-face models (excludes 5K models)
- 1.15 Service Factor (except as noted)
- Capacitor start design for high starting torque
- Capacitor start/capacitor run design for higher efficiency, as noted
- Low temperature manual reset thermal protector
- Totally enclosed and fully gasketed construction for dirty environments
- Condensate drains
- Shaft slinger
- UL Recognized and CSA Certified



Rigid Base

HP	RPM	VOLTS	FRAME	CAT. NO.	MODEL NO.	STOCK	LIST PRICE	MULT. SYMB.	F.L. AMPS	WEIGHT	"C" DIM.	FOOT NOTES
1/3	1800	115/230	56	F13E1	5KC42GN0051Y	✓	\$286	F1	7.8/3.9	22	11.00	d
	1800	115/208-230	56	F101	56C17F5324	✓	\$286	F1	6.6/3.1-3.3	24	11.82	
1/2	1800	115/208-230	56	F12E1	5KC46GN0050Y	✓	\$327	F1	9.0/4.5-4.5	21	11.83	d
	1800	115/208-230	56	F102	56C17F5325	✓	\$327	F1	8.8/4.2-4.4	25	11.82	
3/4	1800	115/230	56	F34E1	5KC46PN0062Y	✓	\$390	F1	11.0/5.5	31	11.83	d,17
	1800	115/208-230	56	F103	56C17F5326	✓	\$390	F1	11.0/5.4-5.5	29	12.32	
1	1800	115/208-230	143T	Z123	143TCFR5328	✓	\$452	S1	13.4/6.8-6.7	31	12.87	
	1800	115/230	56	F10E1	5KC49TN0063Y	✓	\$425	F1	13.2/6.6	37	12.96	d,17
	1800	115/208-230	56	F104	56C17F5327	✓	\$425	F1	13.4/6.8-6.7	31	12.82	
1 1/2	1800	115/208-230	145T	F15E1	5KCR48WN0292Y		\$532	S1	14.5/7.1-7.3	44	14.07	ES,1
	1800	115/208-230	145T	Z118	145TBFR5328	✓	\$532	S1	15.2/8.2-7.6	40	13.87	1
	1800	115/208-230	56H	F100	5KCR48WN0273Y	✓	\$522	F1	14.5/7.1-7.3	44	13.82	d,ES,1
	1800	115/208-230	56H	F105	56B17F5307	✓	\$522	F1	15.2/8.2-7.6	41	13.82	ES,1
2	1800	115/230	145T	Z128	145TBFR5341	✓	\$591	S1	18.8/9.4	49	14.87	1
	1800	208-230	145T	C1904	5KCR49ZN0564Y	✓	\$591	S1	9.2	49	14.63	d,1,17
	1800	115/230	182T	Z119A	182TCFW7072	✓	\$644	S1	24.0/12.0	66	14.46	13
3	1800	230	184T	Z120A	184TBFW17045	✓	\$802	S1	14.2	92	14.96	1,13
5	1800	230	184T	Z121A	184TBFW7737	✓	\$976	S1	19.5	103	17.45	1,13
7 1/2	1800	230	215T	Z122	215TBFW7029	✓	\$1,448	S1	30.0	138	21.48	1

FARM DUTY / AGRICULTURAL

C-Face Footed (Rigid Base)

HP	RPM	VOLTS	FRAME	CAT. NO.	MODEL NO.	STOCK	LIST PRICE	MULT. SYMB.	F.L. AMPS	WEIGHT	"C" DIM.	FOOT NOTES
1/3	1800	115/208-230	56C	F131	56C17F5358	✓	\$349	F1	6.6/3.1-3.3	23	11.82	
1/2	1800	115/208-230	56C	F132	56C17F5912	✓	\$390	F1	8.8/4.2-4.4	25	11.82	
3/4	1800	115/208-230	56C	F133	56C17F5913	✓	\$454	F1	11.5/4.5-5.5	29	12.32	
1	1800	115/208-230	56C	F134	56C17F5914	✓	\$488	F1	13.4/6.8-6.7	31	12.82	
1 1/2	1800	115/208-230	56HC	F135	56B17F5584	✓	\$586	F1	15.2/8.2-7.6	41	13.82	1,5
2	1800	115/230	56HC	K319	56B17F5319	✓	\$601	F1	18.8/9.4	50	14.82	1,5
3	1800	230	184TC	I314A	184TBFW7041	✓	\$901	S1	12.8	86	14.96	1,13
5	1800	230	184TC	I315A	184TBFW7034	✓	\$1,075	S1	19.5	101	17.45	1,13



Farm Duty / Agriculture, Extra-High Torque Chore Motor®

Single Phase, TEFC, Rigid Base

Features:

- Class F insulation
- 1.15 Service Factor
- Ball bearings
- 300% and greater starting torque for hard-to-start applications
- Totally enclosed and fully gasketed for dirty environments
- 213TZ/215TZ models have 1-1/8" shaft, 182TZ model has 7/8" shaft
- Manual reset thermal protector
- Condensate drains
- Shaft slinger
- UL Recognized and CSA Certified



HP	RPM	VOLTS	FRAME	CAT. NO.	MODEL NO.	STOCK	LIST PRICE	MULT. SYMB.	F.L. AMPS	WEIGHT	"C" DIM.	FOOT NOTES
2	1800	115/230	182TZ	Z112A	182TCFW9061	√	\$682	S1	24.0/12.0	68	14.46	2,13
3	1800	230	184T	Z113A	184TCFW9057	√	\$848	S1	19.0	90	16.46	2,13
5	1800	208-230	184T	Z114A	184TBFW7070	√	\$1,034	S1	23.8/21.8	98	14.46	1,13
		230	213TZ	Z117	213TBFW7027	√	\$1,150	S1	23.0	119	18.73	1
7 1/2	1800	230	215TZ	Z115	215TBFW7028	√	\$1,535	S1	32.0	155	21.48	1
10	1800	230	215T	Z116	215TBFW7044	√	\$1,911	S1	40.0	133	21.48	1,17

Farm Duty / Agriculture, Auger Drive

Single Phase, TEFC, N Flange

Features:

- NEMA N flange mounting
- Manual reset thermal protector
- 48NZ: 1/2" dia. X 1.5" long shaft with flat
- 56NZ: 5/8" dia. X 2.06" long shaft with flat
- Extended (ODE) Shaft with flats for manual jogging
- F1201, F1202, F1203, F1204, and F1205 utilize a solid state electronic starting switch
- Ball bearings
- UL Recognized and CSA Certified



HP	RPM	VOLTS	FRAME	CAT. NO.	MODEL NO.	STOCK	LIST PRICE	MULT. SYMB.	F.L. AMPS	WEIGHT	"C" DIM.	FOOT NOTES
1/3	1800	115/230	48NY	HG646	5KH39QN9508Y	√	\$307	F1	5.3/2.7	22	11.07	N,3,83
		115/208-230	56NY	C1291	5KC46GN0075U	√	\$256	F1	5.8/2.8-2.9	21	12.00	
		115/230	48NZ	F1201	48C17F11005	√	\$340	F1	6.2/3.1	22	10.31	E,2
1/2	1800/1500	115/208-230	56NY	C1292	5KC46JN0076U	√	\$338	F1	8.4/4.0-4.2	23	12.00	2,49,50
		115/208-230	48NZ	F1202	48C17F11006	√	\$370	F1	8.0/3.8-4.0	22	10.56	E,2
3/4	1800	115/208-230	56NY	C1293	5KCR49PN0077U	√	\$399	F1	8.4/4.5-4.2	31	13.13	ES,1
		115/208-230	48NZ	F1203	48C17F11007	√	\$431	F1	10.8/5.3-5.4	20	11.31	E,2
1	1800/1500	115/208-230	56NY	C1294	5KCR49UN0079U	√	\$447	F1	10.8/6.0-5.4	40	14.51	ES,1,50,83
		115/230	56NZ	F1204	56C17F15537	√	\$479	F1	13.4/6.7	36	13.38	E,2
1 1/2	1800	115/208-230	56NY	C1295	5KCR49WN0295U	√	\$539	F1	14.5/7.1-7.3	44	14.51	ES,1,83
		115/230	56NZ	F1205	56B17F15516	√	\$576	F1	15.2/7.6	45	14.38	E,1

Grain Stirring, Single Phase

TEFC, Rigid Base

Applications:

Definite purpose for grain stirring systems inside grain bins.

Features:

- 1.15 Service Factor
- Fully gasketed construction to keep grain dust out
- 7/8" diameter shaft
- Fan/Fan guard on shaft end keeps grain dust out of motor
- Durable powder coat paint
- Manual reset thermal protector
- Ball bearings
- UL Recognized and CSA Certified

HP	RPM	VOLTS	FRAME	CAT. NO.	MODEL NO.	STOCK	LIST PRICE	MULT. SYMB.	F.L. AMPS	WEIGHT	"C" DIM.	FOOT NOTES
1 1/2	1800	115/208-230	56HZ	X902	56B17F5324		\$457	F1	15.2/8.2-7.6	46	13.21	1,5

Farm Duty, Capacitor Start

TEAO, Rigid Base - High Efficiency

Applications:

Designed for demanding agricultural belt drive fan applications such as poultry house fans and barn exhaust fans. **Catalog X912 is Totally Enclosed Air Over and must be mounted within the airstream for proper cooling.**

Features:

- Capacitor start/capacitor run design
- Automatic reset thermal protector for higher efficiency
- Suitable for belted loads
- Fully gasketed
- Ball bearings
- UL Recognized and CSA Certified
- Continuous duty



FARM DUTY / AGRICULTURAL

HP	RPM	VOLTS	FRAME	CAT. NO.	MODEL NO.	STOCK	LIST PRICE	MULT. SYMB.	F.L. AMPS	WEIGHT	"C" DIM.	FOOT NOTES
1/2	1725	115/230	56	X913	56B17T20	✓	\$305	F1	4.6/2.3	22	10.47	
1	1725	115/230	56	X912	56B17T5303	✓	\$399	F1	9.2/4.6	32	11.44	

Farm Duty, PSC

TEAO, Resilient Base - Thru Bolt - Variable Speed

Applications:

Designed for demanding agricultural fan applications such as poultry houses and barn exhaust fans. Must be mounted within the airstream for proper cooling. Variable speed capabilities when used with a single phase speed control unit – NOT supplied by Marathon Electric. Super Variable speed motors, catalog X030, X031, and X032, are designed for lower temperature rise throughout a greater speed range.

Features:

- Ball bearings
- Extended thru-bolts
- Fully gasketed
- 48/56 Frame mounting holes
- Continuous duty
- Automatic reset thermal protector
- 1/2" dia. x 2-1/2" long shaft with two flats, 90° apart
- UL Recognized and CSA Certified



HP	RPM	VOLTS	FRAME	CAT. NO.	MODEL NO.	STOCK	LIST PRICE	MULT. SYMB.	F.L. AMPS	WEIGHT	"C" DIM.	FOOT NOTES
1/4	1625	115/230	48YZ	X030	48A17T118	✓	\$218	F1	3.6/1.8	20	11.06	
	1625	115/230	48YZ	X024	48A17T2002	✓	\$178	F1	3.2/1.6	18	10.09	
	1075	115/230	48YZ	X027	48A11T2021	✓	\$194	F1	3.2/1.6	15	10.09	
1/3	1625	115/230	48YZ	X031	48A17T237	✓	\$241	F1	3.8/1.9	23	11.81	
	1625	115/230	48YZ	X025	48A17T2003	✓	\$198	F1	4.4/2.2	18	10.09	
	1075	115/230	48YZ	X028	48A11T2022	✓	\$210	F1	4.2/2.1	21	10.84	
1/2	1625	115/230	48YZ	X032	48A17T119	✓	\$266	F1	5.4/2.7	24	11.81	
	1625	115/230	48YZ	X026	48A17T2004	✓	\$215	F1	6.0/3.0	22	10.84	
	1075	115/230	48YZ	X029	48A11T2023	✓	\$225	F1	6.4/3.2	22	10.84	



Farm Duty / Agricultural

Single Phase, TEAO, Resilient Base-Thru Bolt

Features:

- Split Phase and PSC, as noted
- Ball bearings
- Extended thru-bolts on X1903, X1904, P250, and P251
- 48Z Frame has 1/2" dia. x 2-1/2" long shaft with two flats
- 56Z Frame has 1/2" dia. x 1-7/8" long with 1-5/8" flat
- 48Y & 48YZ have 48/56 Fr. Mounting holes
- 1.0 Service Factor (except as noted)
- Thermal protection, as noted
- Fully Gasketed



FARM DUTY / AGRICULTURAL

HP	RPM	VOLTS	FRAME	OVER LOAD	CAT. NO.	MODEL NO.	STOCK	LIST PRICE	MULT. SYMB.	F.L. AMPS	WEIGHT	"C" DIM.	FOOT NOTES	
1/6	1800	115	48	AUTO	HG196	5KH32GN42S	✓	\$203	F1	3.5	13	8.94	3	
	1800	115	48	NONE	H195	5KH32GN42	✓	\$198	F1	3.5	13	8.94	3	
	1200	115	48	AUTO	H198	5KH35MN132S	✓	\$304	F1	3.7	17	9.57	3	
	1200	115	48	NONE	H197	5KH35MN132	✓	\$293	F1	3.7	17	9.57	3	
1/4	1800	115	48Z	AUTO	X1903	5KH32FNA499S	✓	\$158	F1	5.1	14	9.68	3,9	
	1800	115/208-230	48	AUTO	H649	5KHC39QN9575T	✓	\$329	F1	3.0/1.6-1.5	16	10.40	3	
	1800	115	48	AUTO	H135	5KH32FN3122S	✓	\$215	F1	5.1	15	8.94	3	
	1800	115/230	48Z	AUTO	P250	5KCP35KNB057S	✓	\$209	F1	3.6/1.8	16	10.57	93	
	1800	115	48	NONE	H134	5KH32FN3122	✓	\$204	F1	5.1	15	8.94	3	
	1800	230	48	AUTO	H277	5KH33KN20S	✓	\$240	F1	2.3	15	9.19	3	
	1800/1200	115	48	NONE	H203	5KH36PN106	✓	\$250	F1	4.2/2.7	20	10.00	3	
	1200	115	56	AUTO	H137	5KH49MN6057S	✓	\$358	F1	5.6	22	10.48	3	
	1200	115	56	NONE	H136	5KH49MN6057	✓	\$348	F1	5.6	23	10.48	3	
	1/3	1800	115	48Z	AUTO	X1904	5KH33JNA500S	✓	\$178	F1	6.2	15	9.93	3,9
1800		115	48	AUTO	H139	5KH33JN3121S	✓	\$255	F1	6.2	18	9.19	3	
1800		115	48	NONE	HG138	5KH33JN3121	✓	\$244	F1	6.2	18	9.19	3	
1800		115/208-230	48	AUTO	HG648	5KHC39QN9581T	✓	\$356	F1	4.1/2.1-2.0	17	10.40	3	
1800		230	48	NONE	HG140	5KH36NN37	✓	\$256	F1	2.5	18	10.00	3	
1800		230	48	AUTO	HG141	5KH36NN37S	✓	\$261	F1	2.5	18	10.00	3	
1200		115/230	56	AUTO	HG699	5KH49PN6056S	✓	\$416	F1	7.0/3.5	26	11.48	3	
1200		115/230	56	NONE	HG142	5KH49PN6056	✓	\$404	F1	7.0/3.5	27	11.48	3	
1/2		1800	115/208-230	56	AUTO	H247	5KH42JN0328S	✓	\$242	F1	8.0/4.0-4.0	21	10.05	3
		1200	115/230	48Z	AUTO	P251	5KCP36NNB059S	✓	\$269	F1	7.2/3.6	18	11.0	93
	1800	115/208-230	56	NONE	H276	5KH42JN0328	✓	\$342	F1	8.0/4.0-4.0	21	10.05	3	
	1800	115/208-230	56	AUTO	H647	5KHC39QN9584X	✓	\$377	F1	5.2/2.7-2.6	19	10.05	3	
	1800	115	56	NONE	HG143	5KH42GN0337	✓	\$325	F1	8.0	21	10.05	3,19	
	900	208-230	56Y	AUTO	F781	5KCP49UN9838S	✓	\$312	F1	3.7-3.6	40	11.91	93	
	900	208-230	56Y	AUTO	F780	5KCP49UN9837S	✓	\$305	F1	3.7-3.6	40	11.91	93	
	3/4	1800	115/208-230	56	AUTO	C1314	5KCR49PN0492S	✓	\$313	F1	7.0/3.8-3.5	30	11.38	2,50,55,111
1800		115/208-230	56	AUTO	C1303	5KCR46NN0264T	✓	\$400	F1	8.2/4.0-4.1	28	10.78	2,19	
1	1800	115/208-230	56	AUTO	C1315	5KCR49SN0493S	✓	\$367	F1	10.6/5.5-5.3	34	11.85	2,111	
	1800	115/208-230	56	AUTO	C1302	5KCR49SN0042S	✓	\$419	F1	9.6/5.2-4.8	35	11.91	2,50,55,111	
1 1/2	1800	115/208-230	56	AUTO	C1909	5KCR49ZN0785S	✓	\$431	F1	14.0/7.2-7.0	49	13.96	2,50,55,111	

Crop Dryer, Single Phase

Dripproof/Air Over, Rigid Base

Applications:

Crop dryers with air over/fan on shaft designs.

Features:

- Double sealed ball bearings
- Continuous duty
- Class F insulation system
- Thermostats for thermal overload protection (auto reset protector on Z304)
- 34" long leads for ease of installation
- Keyed shafts with 1/4"-20 UNC tapped hole in end
- Capacitors included, shipped loose on catalog Z307 and Z308, mounted on all other models
- Extra nameplate included, loose, for remote mounting



HP	RPM	VOLTS	FRAME	OVER LOAD	CAT. NO.	MODEL NO.	STOCK	LIST PRICE	MULT. SYMB.	F.L. AMPS	WEIGHT	"C" DIM.	FOOT NOTES
3-4.5	3600	230	145TZ	AUTO	Z304	145TBDR5309	√	\$611	S1	13.0-19.0	43	13.74	1
3-5	3600	230	182TZ	TSTAT	Z309	182TCDR7013		\$734	S1	15.8-25.3	67	15.00	2
5-7.5	3600	230	184TZ	TSTAT	Z305	184TCDR7615	√	\$894	S1	27.0-36.3	73	14.50	d,2
	3600	230	184TZ	TSTAT	Z305A	184TCDW7615	√	\$894	S1	27.2-35.0	98	15.88	2,13
7-10	3600	230	184TZ	TSTAT	Z307A	184TBDW7009	√	\$1,126	S1	31.0-42.0	95	15.88	1,13
7.5-10	3600	230	184TZ	TSTAT	Z313	184TBDR7324		\$1,126	S1	30.0-42.0	89	16.43	1,13
7.5-10.5	3600	230	215TZ	TSTAT	Z314	215TCDW7012		\$1,316	S1	37.0-49.5	139	19.16	2,F
	3600	230	184TZ	TSTAT	Z306	184TCDR7617	√	\$1,009	S1	36.0-45.0	83	15.50	d,2
	3600	230	184TZ	TSTAT	Z306A	184TCDW7617	√	\$1,009	S1	36.5-46.0	83	14.88	2,13
10-15	3600	230	215TZ	TSTAT	Z315	215TBDW7013		\$1,515	S1	39.5-61.5	159	20.42	1,F

FARM DUTY / AGRICULTURAL

Crop Dryer, Three Phase

Dripproof/Air Over, Rigid Base

Applications:

Crop dryers with air over/fan on shaft designs where three phase power is available.

Features:

- Ball bearings
- Thermostats for thermal overload protection
- 34" long leads exit elbow connector in bracket
- Keyed shafts with 1/4"-20 UNC tapped hole in end
- Extra nameplate included, loose, for remote mounting
- Continuous duty
- Class F insulation

HP	RPM	VOLTS	FRAME	CAT. NO.	MODEL NO.	STOCK	LIST PRICE	MULT. SYMB.	F.L. AMPS @ LOW SPEED	WEIGHT	"C" DIM.	FOOT NOTES
5-7	3600	208-220/440	184TZ	Y302	184TTDR7611	√	\$749	E6	17.0-17.0/8.5	64	13.71	d
	3600	208-220/440	184TZ	Y302A	184TTDW7611	√	\$749	E6	13.8-13.2/6.6	71	13.16	13
7-10	3600	208-220/440	184TZ	Y303	184TTDR7612	√	\$794	E6	28.0-27.0/13.5	69	14.22	d
	3600	208-220/440	184TZ	Y1303	184TTDW7612	√	\$794	E6	20.0-19.2/9.6	69	16.19	13
10-15	3600	208-220/440	215TZ	Y304	215TTDW7301	√	\$1,048	E6	28-26.1/13.1	95	17.41	2,13



Farm Duty / Agricultural

Single Phase, TEAO, Direct Drive-Thru Bolt

Features:

- Economical split phase design
- X909 has 1/2" diameter x 1.5" long shaft with flat
- X910 and X911 have 1/2" dia. X 2-1/2" long shaft with two flats, 90 degrees apart
- Thermal protection, as noted
- Ball bearings
- Fully gasketed



Single Speed

HP	RPM	VOLTS	FRAME	OVER LOAD	CAT. NO.	MODEL NO.	STOCK	LIST PRICE	MULT. SYMB.	F.L. AMPS	WEIGHT	"C" DIM.	FOOT NOTES
1/4	1800	115	48Y	MANUAL	X909	48S17T2004	√	\$156	F1	4.0	10	7.62	3,59

Two Speed

HP	RPM	VOLTS	FRAME	OVER LOAD	CAT. NO.	MODEL NO.	STOCK	LIST PRICE	MULT. SYMB.	F.L. AMPS	WEIGHT	"C" DIM.	FOOT NOTES
1/4	1800/1200	115	48YZ	AUTO	X910	48S17T366	√	\$202	F1	4.1/2.5	17	11.09	3,59
1/3	1800/1200	115	48YZ	AUTO	X911	48S17T365	√	\$254	F1	5.3/2.9	18	11.34	3,59

FARM DUTY / AGRICULTURAL

Incubator/Hatchery Vent Fan

Single Phase (PSC), TEAO, Thru-Bolt



HP	RPM	VOLTS	FRAME	CAT. NO.	MODEL NO.	STOCK	LIST PRICE	MULT. SYMB.	F.L. AMPS	WEIGHT	"C" DIM.	FOOT NOTES
1/3	1800	115/230	48Z	P239	5KCP33GNA471S	√	\$352	F1	4.0/2.0	15	10.18	d

Center Pivot Irrigation

Three Phase, TEFC, C-Face footless



HP	RPM	VOLTS	FRAME	CAT. NO.	MODEL NO.	STOCK	LIST PRICE	MULT. SYMB.	F.L. AMPS	WEIGHT	"C" DIM.	FOOT NOTES
1	1800/1500	460/380	56C	K1476	5K49JN4051T	√	\$386	F1	2.0/2.1	23	12.08	50
1 1/2	1800/1500	460/380	56C	K1438	5K49NN4052T	√	\$436	F1	2.4/2.7	29	12.08	50

PowerWash™ XT Washdown Duty, Single Phase

White Epoxy, Totally Enclosed

Features:

- Encapsulated electronic starting switch is impervious to moisture
- Capacitor start induction run design for high starting torque unless otherwise noted
- Class F insulation
- 1.15 Service Factor
- Double sealed ball bearings
- 303 Stainless steel shaft with spring loaded contact seals in each endshield
- Stainless steel conduit box cover, nameplate, fan guard (TEFC) and hardware
- Cast oversized conduit box with high temperature Nitrile gaskets and threaded entrance
- Plugged drain holes in each endshield for all angle mounting
- Internal corrosion resistant coatings on frame, base, endshields, rotor and stator
- USDA-approved, white epoxy RUST-OLEUM® paint
- UL Recognized, CSA Certified and CE Mark



IP55

C-Face Footless

HP	RPM	VOLTS	FRAME	CAT. NO.	MODEL NO.	STOCK	LIST PRICE	MULT. SYMB.	F.L. AMPS	WEIGHT	"C" DIM.	FOOT NOTES
1/3	1800	115/208-230	56C	N531	56C17W5326	✓	\$456	F3	6.4/3.2-3.2	23	10.69	
1/2	3600	115/208-230	56C	N532	56C34W5302	✓	\$456	F3	7.6/4.0-3.8	27	10.69	
	1800	115/208-230	56C	N523	56C17W5327	✓	\$468	F3	8.8/4.4-4.4	26	11.19	
3/4	3600	115/208-230	56C	N524	56C34W5303		\$459	F3	10.0/5.2-5.0	30	11.69	
	1800	115/208-230	56C	N525	56C17W5328	✓	\$541	F3	10.8/5.4-5.4	31	11.69	
1	3600	115/208-230	56C	N526	56C34W5304		\$461	F3	12.0/6.2-6.0	32	12.19	
	1800	115/208-230	56C	N527	56C17W5329	✓	\$613	F3	12.8/6.4-6.4	33	12.19	
1 1/2	3600	115/208-230	56C	N528	56C34W5305		\$680	F3	17.0/8.5-8.5	50	12.69	
	1800	115/208-230	56C	N529	56C17W5330	✓	\$785	F3	19.0/9.5-9.5	23	13.69	

C-Face Footed (Rigid Base)

HP	RPM	VOLTS	FRAME	CAT. NO.	MODEL NO.	STOCK	LIST PRICE	MULT. SYMB.	F.L. AMPS	WEIGHT	"C" DIM.	FOOT NOTES
1/3	1800	115/208-230	56C	N557	56C17W5331	✓	\$459	F3	6.4/3.2-3.2	25	10.69	
1/2	3600	115/208-230	56C	N558	56C34W5307	✓	\$459	F3	7.6/4.0-3.8	26	10.69	
	1800	115/208-230	56C	N559	56C17W5332	✓	\$474	F3	8.8/4.4-4.4	27	11.19	
3/4	3600	115/208-230	56C	N540	56C34W5308	✓	\$463	F3	10.0/5.2-5.0	31	11.69	
	1800	115/208-230	56C	C1286	5KC47NN0723	✓	\$538	F3	10.8/5.6-5.4	31	12.19	d,19
	1800	115/208-230	56C	N541	56C17W5333	✓	\$538	F3	10.8/5.4-5.4	31	11.69	
1	3600	115/208-230	56C	N542	56C34W5309	✓	\$465	F3	12.0/6.2-6.0	33	12.19	
	1800	115/208-230	56C	N543	56C17W5334	✓	\$618	F3	12.8/6.4-6.4	34	12.19	
1 1/2	3600	115/208-230	56C	N544	56C34W5310	✓	\$682	F3	17.0/8.5-8.5	36	12.69	
	1800	115/208-230	56HC	N545	56C17W5335		\$789	F3	19.0/9.5-9.5	43	13.69	5

WASHDOWN - Painted and Stainless Steel

PowerWash™ XT Washdown Duty, Three Phase

White Epoxy, Totally Enclosed

Features:

- 10:1 Variable torque, Constant torque speed range as listed below
- MAX GUARD® Class F insulation system
- 1.15 Service Factor on sinewave, 1.0 Service Factor on IGBT power
- Double sealed ball bearings
- 303 Stainless steel shaft with spring loaded contact seals in each endshield (Drive end only on TENV motors)
- Stainless steel conduit box cover, nameplate, fan guard (TEFC only) and hardware
- Cast oversized conduit box with high temperature nitrile gaskets and threaded entrance
- Plugged drain holes in each endshield for all angle mounting
- Internal corrosion resistant coatings on frame, base, endshields, rotor and stator
- USDA-approved, white epoxy RUST-OLEUM® paint
- UL Recognized, CSA Certified and CE Mark



Rigid Base

HP	RPM	VOLTS	FRAME	CAT. NO.	MODEL NO.	STOCK	CT SPEED RANGE*	LIST PRICE	MULT. SYMB.	NOM. EFF.	F.L. AMPS	WEIGHT	"C" DIM.	FOOT NOTES
1/3	1800	208-230/460	56	E286	5KS49HN4595	✓	10:1	\$450	F3	75.5	1.2-1.6/8	24	9.68	ES,N,20,50
1/2	1800	208-230/460	56	EG287	5KS49MN4608	✓	10:1	\$462	F3	77.0	1.7-1.8/9	27	10.18	d,ES,N,19,50
	1800	208-230/460	56	N322	56T17W5344		10:1	\$462	F3	74.0	2.0-2.0/1.0	25	10.81	V
3/4	1800	208-230/460	56	N320	56T17W5340	✓	10:1	\$492	F3	77.0	2.8-2.8/1.4	25	10.81	V
1	1800	208-230/460	56	N309	56T17V5346	✓	1000:1	\$517	F3	80.0	3.2-3.2/1.6	35	11.18	N
	1800	208-230/460	143T	N310	143TTVR5329	✓	1000:1	\$564	F3	82.5	3.2-3.2/1.6	35	11.62	N
	1200	208-230/460	145T	K2051	5KE49UN8405	✓	10:1	\$760	F3	80.0	4.2-3.6/1.8	41	13.25	d,50
	1200	208-230/460	145T	N323	145TTWR6076	✓	10:1	\$884	F3	82.5	3.6-4.2/2.1	45	13.25	V
1 1/2	1800	208-230/460	145T	N321	145TTWR4029	✓	10:1	\$567	F3	84.0	4.2-4.2/2.1	39	13.12	d,V
	1800	208-230/460	145T	N321A	145TTWR6029	✓	10:1	\$659	F3	86.5	5.2-4.4/2.2	51	12.75	
2	1800	208-230/460	145T	K2053	5KE48WN8366	✓	10:1	\$704	F3	84.0	6.0-5.6/2.8	46	13.75	d,50
	1800	208-230/460	145T	N312A	145TTWR6027	✓	10:1	\$819	F3	86.5	6.0-5.6/2.8	46	13.75	V
3	1800	208-230/460	56HZ	N313	56T17W5328		10:1	\$707	F3	82.5	8.6-8.6/4.3	49	14.25	V,Z,5,17
	1800	208-230/460	182T	N314B	182TTWW6027	✓	10:1	\$1,083	F3	89.5	8.2-8.2/4.1	69	13.96	V
5	3600	208-230/460	184T	N315A	184TTWW6004		10:1	\$1,363	F3	88.5	13.2-12.0/6.0	75	14.46	V
	1800	208-230/460	184T	N316B	184TTWW6027	✓	10:1	\$1,238	F3	89.5	13.0-13.0/6.5	85	14.96	V
7 1/2	3600	208-230/460	184T	N317A	184TTWW6003		10:1	\$1,720	F3	89.5	17.6-16.8/8.4	87	15.96	V
	1800	208-230/460	213T	N318	213TTWR4027	✓	10:1	\$1,329	F3	89.5	20.4-20.4/10.2	140	17.71	d,V
	1800	208-230/460	213T	N318A	213TTWR6027	✓	10:1	\$1,545	F3	91.7	20.4-20.4/10.2	131	17.21	V
10	1800	208-230/460	215T	N319A	215TTWR6027	✓	10:1	\$1,849	F3	91.7	26.0-26.0/13.0	165	18.71	V

Catalog numbers (Cat No.) highlighted in bold blue have efficiency levels that meet EISA requirements

* Requires nameplate modification

Continued on next page.

PowerWash™ XT Washdown Duty, Three Phase

White Epoxy, Totally Enclosed



C-Face Footless

Same features as shown on page 108

HP	RPM	VOLTS	FRAME	CAT. NO.	MODEL NO.	STOCK	CT SPEED RANGE*	LIST PRICE	MULT. SYMB.	NOM. EFF.	F.L. AMPS	WEIGHT	"C" DIM.	FOOT NOTES
1/4	1800	208-230/460	56C	N640	56T17V5326	✓	1000:1	\$436	F3	68.0	1.1-1.1/55	21	9.56	N
1/3	1800	208-230/460	56C	N641	56T17V5327	✓	1000:1	\$463	F3	72.0	1.3-1.3/65	21	9.56	N
1/2	1800	208-230/460	56C	N642	56T17V5328	✓	1000:1	\$478	F3	78.5	1.8-1.8/9	25	10.06	N
3/4	3600	208-230/460	56C	N643	56T34V5301	✓	1000:1	\$482	F3	75.5	2.6-2.4/1.2	50	11.06	N
	1800	208-230/460	56C	N644	56T17V5329	✓	1000:1	\$553	F3	80.0	2.5-2.5/1.25	30	10.56	N
1	3600	208-230/460	56C	N645	56T34V5302	✓	1000:1	\$563	F3	78.5	2.8-2.6/1.3	34	11.56	N
	1800	208-230/460	56C	N646	56T17V5330	✓	1000:1	\$576	F3	80.0	3.2-3.2/1.6	34	11.56	N
	1800	208-230/460	145TC	EG297	5KS49UN8379	✓	10:1	\$576	F3	82.5	3.2-3.2/1.6	39	12.12	d,ES,N,50
	1800	208-230/460	143TC	N647	143TTVR5326	✓	1000:1	\$576	F3	80.0	3.2-3.2/1.6	35	11.75	N
1 1/2	3600	208-230/460	56C	N648	56T34V5303	✓	1000:1	\$597	F3	80.0	4.2-3.8/1.9	42	12.56	N
	1800	208-230/460	56C	K2068	5KE49TN4592	✓	10:1	\$591	F3	84.0	4.4-5.3/2.65	40	13.19	d,50
	1800	208-230/460	56C	N649	56T17V5331	✓	1000:1	\$601	F3	84.0	4.2-4.2/2.1	46	13.06	N
	1800	208-230/460	143TC	N650	143TTVR5327	✓	1000:1	\$601	F3	84.0	4.2-4.2/2.1	47	13.25	N
	1800	208-230/460	145TC	K2055	5KE49TN8378	✓	10:1	\$605	F3	84.0	4.4-5.3/2.65	39	13.25	d,50
2	3600	208-230/460	56C	N651	56T34V5304	✓	1000:1	\$683	F3	82.5	5.6-5.0/2.5	48	13.06	N
	3600	208-230/460	145TC	N652	145TTVR5301		1000:1	\$683	F3	82.5	5.6-5.0/2.5	42	13.25	N
	1800	208-230/460	56C	N653	56T17W5326	✓	10:1	\$700	F3	81.5	6.2-6.2/3.1	38	12.69	V
	1800	208-230/460	56C	K2066	5KE48WN4593	✓	10:1	\$637	F3	84.0	6.0-5.6/2.8	44	13.69	d,50
	1800	208-230/460	145TC	K2056	5KE48WN8364	✓	10:1	\$651	F3	84.0	6.0-5.6/2.8	45	13.75	d,50
	1800	208-230/460	145TC	N654A	145TTWR4326	✓	10:1	\$675	F3	84.0	6.0-5.6/2.8	47	13.75	V
3	3600	208-230/460	145TC	N655	145TTWR5301	✓	10:1	\$839	F3	80.0	8.4-7.6/3.8	36	13.25	d,V
	3600	208-230/460	145TC	N655A	145TTWR4301	✓	10:1	\$897	F3	85.5	8.4-7.6/3.8	48	13.75	V
	1800	208-230/460	182TC	N1656	182TTWW7026	✓	10:1	\$922	F3	82.5	9.0-9.0/4.5	65	14.47	d,V
	1800	208-230/460	182TC	N656B	182TTWW4028	✓	10:1	\$987	F3	87.5	8.4-7.6/3.8	81	14.47	V
5	3600	208-230/460	184TC	N657B	184TTWW4002	✓	10:1	\$1,251	F3	87.5	13.2-12.0/6.0	75	14.47	V
	1800	208-230/460	184TC	N658B	184TTWW4028	✓	10:1	\$1,118	F3	87.5	13.0-13.0/6.5	95	14.97	V
7 1/2	3600	208-230/460	213TC	N659A	213TTWR4001	✓	10:1	\$1,551	F3	88.5	17.6-16.8/8.4	102	17.47	V
	1800	208-230/460	213TC	N660	213TTWR7026		10:1	\$1,328	F3	89.5	24.0-22.0/11.0	125	17.71	V
10	1800	208-230/460	215TC	N661	215TTWR7026		10:1	\$1,507	F3	89.5	29.0-28.0/14.0	150	18.71	V

WASHDOWN - Painted and Stainless Steel

Catalog numbers (Cat No.) highlighted in bold blue have efficiency levels that meet EISA requirements

* Requires nameplate modification

Continued on next page.



PowerWash™ XT Washdown Duty, Three Phase

White Epoxy, Totally Enclosed



C-Face Footed (Rigid Base)

Same features as shown on page 108

HP	RPM	VOLTS	FRAME	CAT. NO.	MODEL NO.	STOCK	CT SPEED RANGE*	LIST PRICE	MULT. SYMB.	NOM. EFF.	F.L. AMPS	WEIGHT	"C" DIM.	FOOT NOTES
1/4	1800	208-230/460	56C	N564	56T17V5332	✓	1000:1	\$438	F3	68.0	1.1-1.1/55	24	10.08	N
	1800	575	56C	N620A	56T17V15501	✓	1000:1	\$438	F3	68.0	0.44	23	10.06	N
1/3	1800	208-230/460	56C	N628	56T17W5334	✓	10:1	\$481	F3	68.0	1.7-1.7/85	23	10.69	V
	1800	575	56C	N621	56T17W5335		10:1	\$481	F3	68.0	0.68	20	10.69	V
1/2	3600	208-230/460	56C	N566	56T34V5305	✓	1000:1	\$437	F3	76.0	1.7-1.6/8	27	10.58	N
	1800	208-230/460	56C	N567	56T17V5336	✓	1000:1	\$490	F3	78.5	1.8-1.8/9	26	10.06	N
	1800	575	56C	N622	56T17V5337	✓	1000:1	\$490	F3	78.5	0.8	25	10.08	N
	1200	208-230/460	56C	N568	56T11V5376	✓	1000:1	\$611	F3	77.0	2.3-2.3/1.15	23	11.56	N
3/4	3600	208-230/460	56C	N569	56T34V5306	✓	1000:1	\$480	F3	75.5	2.6-2.4/1.2	50	11.08	N
	1800	208-230/460	56C	N599	56T17V5338	✓	1000:1	\$567	F3	80.0	2.5-2.5/1.25	31	10.56	N
	1800	575	56C	EG307	5KS49PN4602	✓	10:1	\$567	F3	81.0	1.0	31	10.58	d
	1800	575	56C	N623	56T17W5339	✓	10:1	\$567	F3	77.0	1.1	31	11.19	V
1	1200	208-230/460	56C	N600	56T11V5377		1000:1	\$665	F3	78.5	3.0-3.0/1.5	25	13.06	N,5
	3600	208-230/460	56C	N601	56T34V5307	✓	1000:1	\$561	F3	78.5	2.8-2.6/1.3	35	11.56	N
	1800	208-230/460	56C	N602	56T17V5340	✓	1000:1	\$591	F3	80.0	3.2-3.2/1.6	35	11.58	N
	1800	575	56C	EG311	5KS49UN4598	✓	10:1	\$591	F3	82.5	1.2	39	12.08	d
	1800	575	56C	N627	56T17W5341	✓	10:1	\$591	F3	77.0	1.5	29	11.69	V
	1800	208-230/460	143TC	N626A	143TTWR6028	✓	10:1	\$691	F3	85.5	3.2-3.1/1.55	35	12.75	V
1 1/2	1200	208-230/460	56HC	N604	56T11W5377	✓	10:1	\$713	F3	78.5	4.0-4.0/2.0	36	13.06	5,V
	3600	208-230/460	56C	N605	56T34V5308	✓	1000:1	\$620	F3	80.0	4.2-3.8/1.9	43	12.56	N
	1800	208-230/460	56C	K2067	5KE49TN4597	✓	10:1	\$617	F3	84.0	5.3-4.4/2.2	40	13.19	d
	1800	208-230/460	56C	N606	56T17V5342	✓	1000:1	\$617	F3	84.0	4.2-4.2/2.1	47	13.06	N
	1800	208-230/460	145TC	K2058	5KE49TN8390	✓	10:1	\$617	F3	84.0	5.3-4.4/2.2	40	13.25	d
	1800	208-230/460	145TC	N607	145TTVR5326	✓	1000:1	\$617	F3	84.0	4.2-4.2/2.1	48	13.12	N
	1800	575	145TC	K2059	5KE49TN8398	✓	10:1	\$617	F3	84.0	1.8	42	13.25	d
	1800	575	145TC	N629	145TTVR5030	✓	1000:1	\$617	F3	84.0	1.8	42	13.12	N
	1200	208-230/460	56HC	N608	56T11W5378	✓	10:1	\$753	F3	77.0	5.7-5.7/2.85	50	14.18	5,V
	3600	208-230/460	56HC	N609	56T34V5309	✓	1000:1	\$688	F3	82.5	5.6-5.0/2.5	49	13.06	N,5,17
	3600	208-230/460	145TC	K2060	5KE49TN8389	✓	10:1	\$763	F3	84.0	5.6-5.2/2.6	42	13.25	d
	3600	208-230/460	145TC	N610	145TTVR5302	✓	1000:1	\$763	F3	84.0	5.6-5.0/2.5	49	13.12	N
2	1800	208-230/460	56C	K2065	5KE48WN4586	✓	10:1	\$708	F3	84.0	6.5-6.0/2.8	46	13.69	d
	1800	208-230/460	56C	N611	56T17W5327	✓	10:1	\$708	F3	81.5	6.2-6.2/3.1	38	12.69	V
	1800	575	145TC	K2062	5KE48WN8388	✓	10:1	\$768	F3	84.0	2.3	46	13.75	d
	1800	575	145TC	N630	145TTWR6033	✓	10:1	\$852	F3	86.5	2.3	46	13.75	V
	1800	208-230/460	145TC	N612A	145TTWR6026	✓	10:1	\$852	F3	86.5	6.0-5.6/2.8	46	13.75	V
	3600	230/460	145TC	K2063	5KE49WN8383	✓	10:1	\$905	F3	85.5	7.6/3.8	46	13.75	d
	3600	208-230/460	145TC	N613A	145TTWR6001	✓	10:1	\$1,126	F3	89.5	8.4-7.6/3.8	46	13.75	V
	1800	208-230/460	182TC	N1614	182TTWW4026	✓	10:1	\$1,009	F3	87.5	8.2-8.2/4.1	65	14.47	d,V
5	1800	208-230/460	182TC	N614B	182TTWW6026	✓	10:1	\$1,255	F3	89.5	8.6-7.8/3.9	80	14.47	V
	3600	208-230/460	184TC	N615B	184TTWW6001	✓	10:1	\$1,570	F3	88.5	13.2-12.0/6.0	79	14.47	V
7 1/2	1800	208-230/460	184TC	N616B	184TTWW6026	✓	10:1	\$1,417	F3	88.5	13.6-12.8/6.4	84	14.97	V
	3600	208-230/460	213TC	N617A	213TTWR6002	✓	10:1	\$1,950	F3	89.5	18.6-17.8/8.9	140	17.47	V
10	1800	208-230/460	213TC	N618A	213TTWR6026	✓	10:1	\$1,797	F3	91.7	23.4-21.4/10.7	135	17.71	V
	1800	208-230/460	215TC	N619A	215TTWR6026	✓	10:1	\$2,043	F3	91.7	27.6-26.6/13.3	145	18.71	V

Catalog numbers (Cat No.) highlighted in bold blue have efficiency levels that meet EISA requirements

* Requires nameplate modification

WASHDOWN - Painted and Stainless Steel

PowerWash™ SXT Washdown Duty, Three Phase

All Stainless Steel, Totally Enclosed

Features:

- Suitable for use on VFD 10:1 Variable torque, 10:1 (TEFC) or 1000:1 (TENV) Constant Torque
- MAX GUARD® Class F insulation system
- 1.15 Service Factor on sinewave, 1.0 Service Factor on IGBT power
- Double sealed ball bearings
- 303 stainless steel shaft with spring loaded contact seals in each end. (Drive end only on TENV)
- 300 Series Stainless steel external construction: frame, endshields, conduit box, mounting base and hardware for superior corrosion resistance
- Internal corrosion resistant coatings on rotor and heavy polyester varnish on the stator
- 100% Paint-free construction
- One way condensation drains in each endshield and conduit box for all angle mounting
- Nitrile Buna - N gaskets and seals on conduit box, through bolts and endshields
- Rated 60/50 hertz, 190/380 volt at next lower horsepower
- Nameplate information laser etched on frame
- UL Recognized, CSA Certified and CE Mark



C-Face Footless

HP	RPM	VOLTS	FRAME	CAT. NO.	MODEL NO.	STOCK	LIST PRICE	MULT. SYMB.	NOM. EFF.	F.L. AMPS	WEIGHT	"C" DIM.	FOOT NOTES
1/3	1800	208-230/460	56C	N430	56T17VD5329	✓	\$512	F3	78.5	1.2-1.3/65	30	9.40	N
1/2	1800	208-230/460	56C	N431	56T17VD5330	✓	\$525	F3	81.5	1.5-1.6/1.8	30	9.40	N
3/4	1800	208-230/460	56C	N432	56T17VD5331	✓	\$610	F3	82.5	2.4-2.3/1.2	30	9.40	N
1	1800	208-230/460	56C	N433	56T17WD5330	✓	\$636	F3	82.5	3.2-3.0/1.5	39	13.40	
	1800	208-230/460	143TC	N434	143TTWD5527	✓	\$659	F3	82.5	3.2-3.0/1.5	43	13.62	d
	1800	208-230/460	143TC	N434A	143TTWD4527	✓	\$705	F3	85.5	3.2-3.0/1.5	43	13.62	
1 1/2	1800	208-230/460	56C	N435	56T17WD5331	✓	\$664	F3	84.0	5.8-5.4/4.4	45	13.40	
2	1800	208-230/460	56C	N437	56T17WD5332	✓	\$758	F3	84.0	6.2-5.8/2.9	49	13.40	
	1800	208-230/460	145TC	N438	145TTWD5528	✓	\$784	F3	84.0	6.2-5.8/2.9	50	13.62	d
	1800	208-230/460	145TC	N438A	145TTWD4528	✓	\$838	F3	84.0	6.2-5.8/2.9	50	13.62	

Catalog numbers (Cat No.) highlighted in bold blue have efficiency levels that meet EISA requirements



C-Face Footed (Rigid Base)

HP	RPM	VOLTS	FRAME	CAT. NO.	MODEL NO.	STOCK	LIST PRICE	MULT. SYMB.	NOM. EFF.	F.L. AMPS	WEIGHT	"C" DIM.	FOOT NOTES
1/3	3600	208-230/460	56C	N450	56T34VD5301		\$461	F3	74.0	1.1-1.0/0.5	20	9.40	N
	1800	208-230/460	56C	N410	56T17VD5326	✓	\$515	F3	78.5	1.2-1.3/65	30	9.40	N
1/2	3600	208-230/460	56C	N451	56T34VD5302		\$471	F3	77.0	1.6-1.5/75	25	9.40	N
	1800	208-230/460	56C	N411	56T17VD5328	✓	\$530	F3	81.5	1.5-1.6/8	31	9.40	N
3/4	3600	208-230/460	56C	N452	56T34VD5303	✓	\$517	F3	78.5	2.2-2.0/1.0	31	9.40	N
	1800	208-230/460	56C	N412	56T17VD5327	✓	\$613	F3	82.5	2.4-2.3/1.15	40	12.06	N
1	3600	208-230/460	56C	N453	56T34WD5301		\$608	F3	80.0	2.9-2.6/1.3	25	13.40	5
	3600	208-230/460	143TC	N454	143TTWD4001	✓	\$657	F3	80.0	2.9-2.6/1.3	40	13.87	d
	3600	208-230/460	143TC	N454A	143TTWD6001	✓	\$764	F3	80.0	2.9-2.6/1.3	40	13.87	
	1800	208-230/460	56C	N413	56T17WD5326	✓	\$638	F3	82.5	3.2-3.0/1.5	45	12.13	5
	1800	208-230/460	143TC	N414	143TTWD4026	✓	\$690	F3	82.5	3.2-3.0/1.5	45	13.69	d
	1800	208-230/460	143TC	N414A	143TTWD6026	✓	\$858	F3	85.5	3.2-3.0/1.5	48	13.62	
1 1/2	3600	208-230/460	56C	N455	56T34WD5302	✓	\$670	F3	82.5	4.2-3.8/1.9	46	13.40	5
	3600	208-230/460	143TC	N456	143TTWD4002	✓	\$726	F3	82.5	4.2-3.8/1.9	48	13.87	d
	3600	208-230/460	143TC	N456A	143TTWD6002	✓	\$902	F3	84.0	4.2-3.8/1.9	48	13.62	
2	1800	208-230/460	56C	N415	56T17WD5329	✓	\$666	F3	84.0	5.0-4.8/2.4	40	14.25	5
	3600	208-230/460	56C	N457	56T34WD5303	✓	\$743	F3	84.0	5.6-5.0/2.5	47	13.40	5
	3600	208-230/460	145TC	N458A	145TTWD6001	✓	\$1,081	F3	85.5	5.6-5.0/2.5	50	13.62	
	1800	208-230/460	56C	N417	56T17WD5328	✓	\$760	F3	84.0	6.2-5.8/2.9	50	14.25	5
	1800	208-230/460	145TC	N418	145TTWD4029	✓	\$852	F3	84.0	6.2-5.8/2.9	50	13.69	d
	1800	208-230/460	145TC	N418A	145TTWD6029	✓	\$1,059	F3	86.5	6.2-5.8/2.9	53	13.62	

Catalog numbers (Cat No.) highlighted in bold blue have efficiency levels that meet EISA requirements



PowerWash™ SXT-Plus Washdown Duty, Three Phase Stainless/BISSC, Totally Enclosed

Features:

- Suitable for use on VFD, 10:1 Variable torque, 10:1 (TEFC) or 1000:1 (TENV) Constant Torque, 1.0 Service Factor
- MAX GUARD® Class F insulation system
- 1.15 Service Factor on sinewave, 1.0 Service Factor on IGBT power
- Double sealed ball bearings with moisture resistant, high temperature grease
- 300 Series Stainless steel external construction: frame, endshields, shaft, conduit box, mounting base and hardware for superior corrosion resistance
- Internal corrosion resistant coatings on rotor and heavy polyester varnish on the stator
- 100% Paint-free construction
- Viton® o-rings, shaft seals, and gaskets for superior sealing against chemicals
- Hydrophic breather in OP endshield and conduit box equalize air pressure
- Nameplate information laser etched on frame
- BISSC Certified for baking industry
- UL Recognized, CSA Certified and CE Mark



C-Face Footed (Rigid Base)

HP	RPM	VOLTS	FRAME	CAT. NO.	MODEL NO.	STOCK	LIST PRICE	MULT. SYMB.	NOM. EFF.	F.L. AMPS	WEIGHT	"C" DIM.	FOOT NOTES
1/2	1800	208-230/460	56HC	N400	56T17V5347		\$966	F3	78.0	1.6-1.6/8	37	12.54	N,5
3/4	1800	208-230/460	56HC	N401	56T17V5348	✓	\$1,003	F3	83.6	2.4-2.3/1.15	42	11.71	N,5
1	1800	208-230/460	56HC	N402	56T17V5349	✓	\$1,026	F3	82.0	2.4-2.3/1.15	47	13.54	N,5
	1800	208-230/460	143TC	N403	143TTVD5326		\$1,026	F3	82.0	3.1-3.0/1.5	50	13.61	N,5
1 1/2	1800	208-230/460	145TC	N404A	145TTWD6026		\$1,200	F3	86.5	4.5-4.4/2.2	52	14.25	
	1800	208-230/460	145TC	N405A	145TTWD6027	✓	\$1,491	F3	86.5	5.6-5.6/2.8	50	13.69	
3	1800	208-230/460	182TC	N406A	182TTWD6031	✓	\$1,791	F3	89.5	8.8-8.2/4.1	85	14.77	
5	1800	208-230/460	184TC	N407A	184TTWD6031	✓	\$2,043	F3	89.5	13.8-13.0/6.5	96	15.27	
7 1/2	1800	208-230/460	213TC	N408A	213TTWD6031	✓	\$3,056	F3	91.7	22.4-20.4/10.8	160	18.69	
	1800	208-230/460	215TC	N409A	215TTWD6031	✓	\$3,148	F3	91.7	28.0-26.0/13.0	173	18.69	

Catalog numbers (Cat No.) highlighted in bold blue have efficiency levels that meet EISA requirements

PowerWash™ Coupler Brakes

PowerWash™ coupler brakes are specifically designed for use with PowerWash™ Washdown Duty motors. Rated for NEMA 4X/IP55, these brakes are suitable for applications with high moisture or pressure washdown. Painted with a special white epoxy food-safe paint, these brakes are **BISSC Certified**.

ENCLOSURE NEMA 4X/IP55	CAT. NO.	KIT NO.	STOCK	LIST PRICE	MULT. SYMB.	WEIGHT
3 ft. lb.	A909	KIT 909	✓	\$755	S4	12
6 ft. lb.	A910	KIT 910	✓	\$816	S4	12
10 ft. lb.	A911	KIT 911	✓	\$897	S4	12

Carbonator Pump, Split Phase Dripproof

Features:

- Ball bearings
- 1.0 Service Factor (except as noted)
- Completely interchangeable with OEM units
- Automatic reset thermal protector
- UL Recognized and CSA Certified



Single Shaft



Double Shaft

HP	RPM	VOLTS	FRAME	CAT. NO.	MODEL NO.	STOCK	LIST PRICE	MULT. SYMB.	F.L. AMPS	WEIGHT	"C" DIM.	FOOT NOTES
1/4	1800/1500	208-240	48Y	H451	5KH32GNB813X	✓	\$167	F1	2.3-2.4	14	7.69	12,68
	1800/1500	115/230	48Z	H344	5KH36KNB633X	✓	\$139	F1	4.3/2.2	16	8.75	12
	1800	115	48Y	4725	5KH32DN5587X	✓	\$139	F1	5.0	13	7.69	12
	1800	115	48Y	HG679	5KH32DN5597X	✓	\$132	F1	5.0	11	7.69	82
1/3	1800/1500	100-120/200-240	48Y	HG681	5KH32GNB814X	✓	\$174	F1	5.5-5.6/2.7-2.8	14	7.69	68,82
	1800/1500	100-120/200-240	48Y	H683	5KH33GNA444X	✓	\$196	F1	5.5-5.6/2.7-2.8	14	7.94	12
	1800/1500	100-120/200-240	48Y	4805	5KH32GNB811X	✓	\$182	F1	5.5-5.6/2.7-2.8	14	7.69	12,68
	1800/1500	220-240	48Y	HG450	5KH32GNB812X	✓	\$176	F1	2.7-2.7	14	7.69	12,68
	1800	115	48Y	4406	5KH32FN5586X	✓	\$152	F1	5.6	14	7.69	12,18
	1800	115	48Y	HG680	5KH32FN5598X	✓	\$146	F1	5.6	14	7.69	18,82
	1800	115	48Y	H682	5KH32ENA443X	✓	\$176	F1	6.1	13	7.69	12
1/2	1800	115	48Y	H926	5KH36MNB637X	✓	\$227	F1	7.2	17	8.75	12
	1800/1500	100-120/200-240	48Y	H684	5KH36MNA445X	✓	\$227	F1	7.1-7.2/3.4-3.6	17	8.75	12,68
3/4	1800	115/230	48Y	HG714	5KH37PNA479X	✓	\$302	F1	10.4/5.2	19	9.15	12

Double Shaft

HP	RPM	VOLTS	FRAME	CAT. NO.	MODEL NO.	STOCK	LIST PRICE	MULT. SYMB.	F.L. AMPS	WEIGHT	"C" DIM.	FOOT NOTES
1/3	1800/1500	100-120/200-240	48Y	H712	5KH32GNB815X	✓	\$186	F1	5.5-5.6/2.7-2.8	14	9.47	68

Sump Pump, Split Phase Dripproof

Features:

- Sleeve bearings
- 1.0 Service Factor
- Float switch & cord set
- Completely interchangeable with OEM units
- Automatic reset thermal protector
- UL Recognized and CSA Certified



PUMP MOTORS (FLUID HANDLING)

HP	RPM	VOLTS	FRAME	CAT. NO.	MODEL NO.	STOCK	LIST PRICE	MULT. SYMB.	F.L. AMPS	WEIGHT	"C" DIM.	FOOT NOTES
1/3	1800	115	48K	H641	5KH39CN5501X	✓	\$162	F1	5.7	12	9.6	4,15
	1800	115	48K	H642	5KH39CN5504X	✓	\$162	F1	5.7	12	9.6	4,16
1/4	1800	115	48K	H950	5KH140DFK1X	✓	\$162	F1	5.0	11	7.9	4,15
1/2	1800	115	48K	H951	5KH140DFK17X	✓	\$212	F1	7.3	17	8.7	4,15



Jet Pump, Two-Compartment

Single Phase, Dripproof

Features:

- Two-compartment design for easy servicing
- 50° C Ambient
- Fixed CW rotation, viewed opposite shaft end
- UL Recognized and CSA Certified



C-Face Footless, 56C/56J

HP	RPM	VOLTS	FRAME	CAT. NO.	MODEL NO.	STOCK	LIST PRICE	MULT. SYMB.	SERVICE FACTOR	F.L. AMPS	WEIGHT	"C" DIM.	FOOT NOTES
1/3	3600	115	56C	H439	5KH39EN2552X	√	\$189	F1	1.75	6.2	18	11.03	3
	3600	115	56J	H440	5KH39EN2506X	√	\$192	F1	1.75	6.2	18	11.54	3
	3600	115	56J	H685	5KH39EN2887X	√	\$200	F1	1.75	6.2	13	11.54	3
	3600	115/230	56C	C1081	5KC39EN2553X	√	\$209	F1	1.75	6.2/3.1	15	11.03	2
	3600	115/230	56J	C1087	5KC39EN2500X	√	\$215	F1	1.75	6.2/3.1	15	11.54	2
1/2	3600	115/230	56C	C1082	5KC39HN2554X	√	\$219	F1	1.6	8.2/4.1	15	11.03	2
	3600	115/230	56J	C1088	5KC39HN2501X	√	\$224	F1	1.6	8.2/4.1	15	11.54	2
	3600	115/230	56J	C1462	5KC39HN2888X	√	\$230	F1	1.6	8.2/4.1	16	11.54	12,18
3/4	3600	115/230	56C	C1083	5KC33MN2555X	√	\$243	F1	1.5	11.6/5.8	17	12.01	18,82
	3600	115/230	56J	C1089	5KC33MN2502X	√	\$249	F1	1.5	11.6/5.8	17	12.42	2
	3600	115/230	56J	C1463	5KC33MN2889X	√	\$256	F1	1.5	11.6/5.8	19	12.42	2
1	3600	115/230	56C	C1084	5KC39SN2810X	√	\$278	F1	1.4	14.2/7.1	25	13.47	2
	3600	115/230	56J	C1090	5KC39SN2812X	√	\$285	F1	1.4	14.2/7.1	26	13.98	2
	3600	115/230	56J	C1464	5KC39SN2890X	√	\$289	F1	1.4	14.2/7.1	26	13.98	2
1 1/2	3600	115/230	56C	C1085	5KCR39SN2557X	√	\$370	F1	1.3	15.8/7.9	21	13.47	1
	3600	115/230	56J	C1091	5KCR39SN2504X	√	\$377	F1	1.3	15.8/7.9	21	13.98	1
	3600	115/230	56J	C1465	5KCR39SN2891X	√	\$382	F1	1.3	15.8/7.9	21	13.98	1
2	3600	115/230	56C	C1086	5KCR39UN2558X	√	\$452	F1	1.2	19.2/9.6	23	13.47	1
	3600	115/230	56J	C1092	5KCR39UN2505X	√	\$458	F1	1.2	19.2/9.6	23	13.98	1
	3600	115/230	56J	C1466	5KCR39UN2892X	√	\$463	F1	1.2	19.2/9.6	23	13.98	1



Square Flange

HP	RPM	VOLTS	FRAME	CAT. NO.	MODEL NO.	STOCK	LIST PRICE	MULT. SYMB.	SERVICE FACTOR	F.L. AMPS	WEIGHT	"C" DIM.	FOOT NOTES
1/3	3600	115/230	56Y	C1168	5KC36GN2507X	√	\$215	F1	1.95	6.4/3.2	15	11.59	2
1/2	3600	115/230	56Y	C1169	5KC36MN2508X	√	\$216	F1	1.9	10.8/5.4	17	11.59	2
3/4	3600	115/230	56Y	C1170	5KC38PN2509X	√	\$227	F1	1.65	12.6/6.3	19	12.59	2
1	3600	115/230	56Y	C1171	5KC38SN2510X	√	\$256	F1	1.65	16.4/8.2	21	12.59	2
1 1/2	3600	230	56Y	C1172	5KCR39UN2511X	√	\$293	F1	1.5	7.6	23	13.12	1
2	3600	230	56Y	C1173	5KCR39UN2512X	√	\$390	F1	1.3	8.7	23	13.12	1

PUMP MOTORS (FLUID HANDLING)

Centrifugal Pump (Jet Pump)

Single Phase, Dripproof

Features:

- Service Factor, as noted
- Double sealed ball bearings, mechanically locked on shaft end
- Capacitor start design for high starting torque
- Capacitor start/capacitor run design for higher efficiency, as noted
- Fixed CW rotation, viewed opposite shaft end
- Automatic reset thermal protector
- 56C = carbon steel shaft with key
- 56J = 416 stainless steel threaded shaft with slinger
- Drip cover not included, see Accessories Section
- UL Recognized and CSA Certified



C-Face Footless, 56C/56J

HP	RPM	VOLTS	FRAME	CAT. NO.	MODEL NO.	STOCK	LIST PRICE	MULT. SYMB.	SERVICE FACTOR	F.L. AMPS	WEIGHT	"C" DIM.	FOOT NOTES
1/3	3600	115/230	56C	J1025	5KC37FN71X	✓	\$154	F1	1.75	6.4/3.2	14	10.71	3
	3600	115/230	56J	C329	5KC37FN65X	✓	\$162	F1	1.75	6.4/3.2	14	11.22	15
	1800/1500	115/208-230	56J	C683	5KC36LN84X	✓	\$350	F1	1.35	6.0/3.2-3.0	17	10.82	15,50
1/2	3600	115/230	56C	C330	5KC36JN268X	✓	\$169	F1	1.6	7.6/3.8	18	10.31	
	3600	115/230	56J	C331	5KC36JN269X	✓	\$176	F1	1.6	7.6/3.8	18	10.82	15
3/4	3600	115/230	56C	C332	5KC39NN50X	✓	\$199	F1	1.5	11.2/5.6	19	11.84	
	3600	115/230	56J	C333	5KC39QN3219X	✓	\$206	F1	1.5	11.2/5.6	18	12.40	15
	2900	110/220	56C	CG732	5KC39RN114T	✓	\$342	F1	1.5	9.8/4.9	28	12.60	50
1	3600	115/230	56C	C334	5KC39RN44X	✓	\$223	F1	1.4	13.2/6.6	22	12.59	
	3600	115/230	56J	C335	5KC39RN45X	✓	\$229	F1	1.4	13.2/6.6	22	13.14	15
1 1/2	3600	115/208-230	56C	C336	5KC49NN2140X	✓	\$304	F1	1.3	18.4/9.8-9.2	27	11.38	
	3600	115/230	56J	C337	5KC49NN2167X	✓	\$323	F1	1.3	18.4/9.2	26	11.89	
2	3600	115/208-230	56C	C338	5KC49TN2141X	✓	\$377	F1	1.2	21.2/11.5-10.6	38	13.22	
	3600	115/208-230	56J	C339	5KC49TN2170X	✓	\$396	F1	1.2	21.2/10.6	36	13.73	
3	3600	115/230	56C	C340	5KCR48TN2142T	✓	\$699	F1	1.15	29.4/14.7	38	12.66	1
	3600	115/230	56J	C341	5KCR48TN2174T	✓	\$631	F1	1.15	29.4/14.7	38	13.17	1,15

C-Face Footed (Rigid Base), 56J

Additional Features:

- Drip cover included

HP	RPM	VOLTS	FRAME	CAT. NO.	MODEL NO.	STOCK	LIST PRICE	MULT. SYMB.	SERVICE FACTOR	F.L. AMPS	WEIGHT	"C" DIM.	FOOT NOTES
1/3	3600	115/208-230	56J	J054	56C34D2118	✓	\$167	F1	1.75	5.6/2.7-2.8	15	10.94	3
1/2	3600	115/208-230	56J	J055	56C34D2119	✓	\$181	F1	1.6	7.4/3.5-3.7	17	11.19	15
3/4	3600	115/208-230	56J	J056	56C34D2120	✓	\$211	F1	1.5	9.8/4.8-4.9	20	11.44	15,50
1	3600	115/208-230	56J	J057	56C34D2121	✓	\$234	F1	1.4	12.0/6.2-6.0	23	12.44	
1 1/2	3600	115/208-230	56J	J058	56B34D2033	✓	\$327	F1	1.3	13.4/7.4-6.7	23	12.43	1
2	3600	115/208-230	56J	J059	56B34D5341	✓	\$402	F1	1.2	18.2/9.8-9.1	33	11.94	1

Single Phase, Totally Enclosed

Features:

- Service Factor, as noted
- Double sealed ball bearings, mechanically locked on shaft end
- Capacitor start design for high starting torque
- Capacitor start/capacitor run design for higher efficiency, as noted
- Reversible CW rotation, viewed opposite shaft end
- Automatic reset thermal protector
- 56C = carbon steel shaft with key
- 56J = 416 stainless steel threaded shaft with slinger
- UL Recognized and CSA Certified



PUMP MOTORS (FLUID HANDLING)

HP	RPM	VOLTS	FRAME	CAT. NO.	MODEL NO.	STOCK	LIST PRICE	MULT. SYMB.	SERVICE FACTOR	F.L. AMPS	WEIGHT	"C" DIM.	FOOT NOTES
1/3	3600	115/230	56J	C1336	5KC33FN4180X	✓	\$282	F1	1.0	5.6/2.8	14	11.87	
1/2	3600	115/230	56J	C465	5KC39QN3218X	✓	\$350	F1	1.15	7.4/3.7	19	11.9	15
3/4	3600	115/230	56C	C847	5KC37NN115X	✓	\$373	F1	1.0	9.8/4.9	22	11.76	
1	3600	115/230	56J	C352	5KC49NN2135X	✓	\$402	F1	1.15	13.0/6.5	27	12.95	15
2	3600	115/230	56J	C878	5KCR49TN2164T	✓	\$604	F1	1.0	17.8/8.9	38	14.79	ES,1,15

Catalog numbers in () are GE catalog numbers that are no longer valid and have been replaced by MEMC/GE catalog numbers.

SB300 - Prices and Specifications are subject to change without notice.

Motors for the long run



Centrifugal Pump (Jet Pump)

Three Phase, Dripproof

Features:

- Service Factor, as noted
- Double sealed ball bearings, mechanically locked on shaft end
- Continuous Duty
- Nameplated 60/50 hertz, 190/380 volts at next lower HP, as noted
- 56C = carbon steel shaft with key
- 56J = 416 stainless steel threaded shaft with slinger
- UL Recognized and CSA Certified
- Drip cover not included, see Accessories section



C-Face Footed (Rigid Base)

C-Face Footless, 56C/56J

HP	RPM	VOLTS	FRAME	CAT. NO.	MODEL NO.	STOCK	LIST PRICE	MULT. SYMB.	SERVICE FACTOR	F.L. AMPS	WEIGHT	"C" DIM.	FOOT NOTES
1/3	3600	208-230/460	56C	KG215	5K35FN55	✓	\$177	F1	1.75	1.5-1.8/0.9	14	9.90	68
	3600	208-230/460	56J	K748	5K35FN101	✓	\$178	F1	1.75	1.5-1.8/0.9	14	10.40	48
1/2	3600	208-230/460	56C	K216	5K36JN57	✓	\$201	F1	1.6	2.0-2.0/1.0	16	10.31	48,68
	3600	208-230/460	56J	K217	5K36JN56	✓	\$202	F1	1.6	2.0-2.0/1.0	16	10.82	48,68
	1800	208-230/460	56J	K553	5K42HN4139	✓	\$397	F1	1.25	2.3-2.2/1.1	18	10.41	48
3/4	3600	208-230/460	56C	K218	5K37MN37	✓	\$242	F1	1.5	2.6-2.6/1.3	18	10.70	48,68
	3600	208-230/460	56J	KG219	5K37MN38	✓	\$243	F1	1.5	2.6-2.6/1.3	17	11.22	48,68
	1800	208-230/460	56J	K555	5K46KN4141	✓	\$467	F1	1.25	3.3-3.0/1.5	24	11.24	48
1	3600	208-230/460	56C	K220	5K38PN47	✓	\$275	F1	1.4	3.3-3.2/1.6	19	11.30	48,68
	3600	208-230/460	56J	K221	5K38PN48	✓	\$276	F1	1.4	3.3-3.2/1.6	19	11.82	48,68
	1800	208-230/460	56J	K750	5K46MN4144	✓	\$483	F1	1.15	3.6-3.8/1.9	27	11.24	48
1 1/2	3600	208-230/460	56C	K222	5K46KN2173	✓	\$335	F1	1.3	5.0-4.8/2.4	24	10.73	48,68
	3600	208-230/460	56J	K223	5K46KN2172	✓	\$336	F1	1.3	5.0-4.8/2.4	23	11.24	48,68
	1800	208-230/460	56J	K751	5K49PN4121	✓	\$533	F1	1.15	5.8-5.6/2.8	28	11.84	48
2	3600	208-230/460	56C	K224	5K49NN2180	✓	\$392	F1	1.2	6.0-6.0/3.0	27	11.33	48,68
	3600	208-230/460	56J	K225	5K49NN2178	✓	\$392	F1	1.2	6.0-6.0/3.0	27	11.84	48,68
3	3600	208-230/460	56C	K226	5K48TN2182	✓	\$440	F1	1.15	8.9-8.2/4.1	38	12.61	48,68
	3600	208-230/460	56J	K227	5K48TN2181	✓	\$443	F1	1.15	8.9-8.2/4.1	38	13.12	48,68
	3600	115/230	56J	C1092	5KCR39UN2505X	✓	\$458	F1	1.2	19.2/9.6	23	13.98	1
	3600	115/230	56J	C1466	5KCR39UN2892X	✓	\$463	F1	1.2	19.2/9.6	23	13.98	1

Additional Features:

- Drip cover is included

C-Face Footed (Rigid Base), 56J

HP	RPM	VOLTS	FRAME	CAT. NO.	MODEL NO.	STOCK	LIST PRICE	MULT. SYMB.	SERVICE FACTOR	F.L. AMPS	WEIGHT	"C" DIM.	FOOT NOTES
1/3	3600	208-230/460	56J	J047	56T34D5368		\$183	F1	1.75	1.2-1.1/1.55	21	10.43	68
1/2	3600	208-230/460	56J	J048	56T34D5367	✓	\$206	F1	1.6	2.1-2.2/1.1	21	10.93	68
3/4	3600	208-230/460	56J	J049	56T34D5365	✓	\$247	F1	1.5	2.6-2.6/1.3	22	11.22	68
1	3600	208-230/460	56J	J050	56T34D5366	✓	\$281	F1	1.4	3.7-3.7/1.85	23	10.93	68
1 1/2	3600	208-230/460	56J	J051	56T34D5369	✓	\$341	F1	1.15	5.0-4.8/2.4	23	11.24	68
2	3600	208-230/460	56J	J052	56T34D5370	✓	\$399	F1	1.2	6.4-6.2/3.1	30	10.93	68
3	3600	208-230/460	56J	J053	56T34D5371	✓	\$447	F1	1.15	8.9-8.4/4.2	32	11.93	68

PUMP MOTORS (FLUID HANDLING)

Centrifugal Pump (Jet Pump)

Three Phase, Totally Enclosed



Features:

- Service Factor, as noted
- Double sealed ball bearings, mechanically locked on shaft end
- Continuous Duty
- Nameplated 60/50 hertz, 190/380 volts at next lower HP, as noted
- 56C = carbon steel shaft with key, drip cover not included, see Accessories Section
- 56J = 416 stainless steel threaded shaft with slinger
- UL Recognized, CSA Certified, and CE Mark

C-Face Footless, 56C/56J

HP	RPM	VOLTS	FRAME	CAT. NO.	MODEL NO.	STOCK	LIST PRICE	MULT. SYMB.	SERVICE FACTOR	F.L. AMPS	WEIGHT	"C" DIM.	FOOT NOTES
1/3	3600	208-230/460	56C	P101	56T34T5306	✓	\$205	F1	1.35	1.7-2.0/1.0	18	9.94	N,68
1/2	3600	208-230/460	56C	P102	56T34F5321	✓	\$228	F1	1.15	2.1-2.2/1.1	21	11.82	12,18
	3600	200-230/460	56J	K230	5K35JN47	✓	\$331	F1	1.6	2.1-2.0/1.0	17	11.40	18,82
3/4	1800	208-230/460	56J	K550	5K42HN4133	✓	\$402	F1	1.0	2.3-2.2/1.1	22	11.52	48
	3600	208-230/460	56C	P103	56T34F5322	✓	\$270	F1	1.15	3.0-3.2/1.6	22	11.82	68
1	3600	208-230/460	56J	KG232	5K36MN339	✓	\$366	F1	1.5	2.6-2.6/1.3	16	11.90	48
	3600	208-230/460	56C	P104	56T34F5323	✓	\$303	F1	1.15	3.7-3.7/1.85	24	11.82	68
1 1/2	3600	200-230/460	56J	KG234	5K38RN49	✓	\$420	F1	1.4	3.2-3.0/1.5	25	12.90	48
	3600	208-230/460	56C	P105	56T34F5324	✓	\$352	F1	1.15	4.6/2.3	25	11.82	68
2	3600	200-230/460	56J	KG236	5K49PN2330	✓	\$452	F1	1.3	4.8-4.2/2.1	31	12.95	48
	3600	208-230/460	56C	P106	56T34F5325	✓	\$408	F1	1.15	6.0-6.0/3.0	29	12.32	68
3	3600	200-230/460	56J	K238	5K49SN2184	✓	\$513	F1	1.2	5.8-5.4/2.7	35	13.48	48
	3600	208-230/460	56C	P107	56T34F5326	✓	\$443	F1	1.15	8.4-7.6/3.8	38	13.32	68
	3600	230/460	56J	K240	5K49ZN2190	✓	\$621	F1	1.0	8.0/4.0	49	14.79	48



Additional Features:

- Drip cover included

C-Face Footed (Removable Base), 56J

HP	RPM	VOLTS	FRAME	CAT. NO.	MODEL NO.	STOCK	LIST PRICE	MULT. SYMB.	SERVICE FACTOR	F.L. AMPS	WEIGHT	"C" DIM.	FOOT NOTES
1/3	3600	208-230/460	56J	J060	56T34T5308		\$225	F1	1.15	1.7-2.0/1.0	21	10.44	N,68
1/2	3600	208-230/460	56J	J061	56T34F5342	✓	\$247	F1	1.15	2.1-2.2/1.1	23	12.32	68
3/4	3600	208-230/460	56J	J062	56T34F5343	✓	\$290	F1	1.15	3.0-3.2/1.6	23	12.32	68
1	3600	208-230/460	56J	J063	56T34F5344	✓	\$323	F1	1.15	3.7-3.7/1.85	25	12.32	68
1 1/2	3600	208-230/460	56J	J064	56T34F5345	✓	\$388	F1	1.15	4.7-4.6/2.3	26	12.32	68
2	3600	208-230/460	56J	J065	56T34F5346	✓	\$445	F1	1.15	6.0-6.0/3.0	30	12.82	68
3	3600	208-230/460	56J	J066	56T34F5347	✓	\$507	F1	1.15	8.4-7.6/3.8	40	13.82	68

PUMP MOTORS (FLUID HANDLING)



Close-Coupled Pump, JM

Single Phase, Dripproof

Applications:

Close-coupled pumps where the pump impeller is mounted directly on the motor shaft in environments that are relatively clean and dry.

Features:

- NEMA JM pump shaft dimensions
- Ball bearings, mechanically locked on shaft end
- Capacitor start design for high starting torque
- Capacitor start / capacitor run design for higher efficiency, as noted
- Continuous duty
- 1.15 Service Factor
- UL Recognized and CSA Certified



C-Face Footed (Rigid Base)

HP	RPM	VOLTS	FRAME	CAT. NO.	MODEL NO.	STOCK	LIST PRICE	MULT. SYMB.	NOM. EFF.	F.L. AMPS	WEIGHT	"C" DIM.	FOOT NOTES
1	1800	115/208-230	143JM	Z401	143TCDR5328		\$427	S2	72.0	13.4/6.8-6.7	34	13.62	68
1 1/2	1800	115/208-230	145JM	Z403	145TCDR5328		\$475	S2	77.0	18.0/9.3-9.0	43	14.62	68
2	3600	115/208-230	145JM	Z404	145TBDR5304		\$478	S2	78.5	19.2/10.5-9.6	36	13.62	1
	1800	115/230	182JM	Z405A	182TCDW7074	✓	\$545	S2	72.0	23.0/11.5	69	16.09	13
3	3600	115/230	182JM	Z406A	182TCDW7318	✓	\$605	S2	75.5	32.0/16.1	60	15.32	13
	1800	115/230	184JM	Z407	184TCDR7047	✓	\$707	S2	75.5	33.0/16.5	78	17.59	d
	1800	115/230	184JM	Z407A	184TCDR7047	✓	\$707	S2	75.5	33.0/16.5	77	17.59	13
5	3600	230	184JM	Z408	184TCDR7011	✓	\$886	S2	80.0	24.0	93	17.09	d,CF
	3600	230	184JM	Z408A	184TBDW17007	✓	\$886	S2	80.0	22.0	93	16.32	1,13
	1800	230	213JM	Z409	213TCDW7027	✓	\$972	S2	78.5	28.0	115	19.92	
7 1/2	3600	230	213JM	Z410	213TCDW7002	✓	\$1,106	S2	78.5	37.0	106	18.42	
	1800	230	215JM	Z411	215TBDW7029	✓	\$1,343	S2	84.0	34.5	120	19.92	1
10	3600	230	215JM	Z412	215TCDW7002	✓	\$1,423	S2	81.5	47.0	150	19.92	
	1800	230	215JM	Z413	215TBDW7027	✓	\$1,628	S2	82.5	44.0	159	21.17	1

Close-Coupled Pump, JM

Single Phase, Totally Enclosed

Applications:

Close-coupled pumps where the pump impeller is mounted directly on the motor shaft in damp, dusty, or dirty environments.

Features:

- NEMA JM pump shaft dimensions
- Ball bearings, mechanically locked on shaft end
- Capacitor start/capacitor run design for higher efficiency
- Continuous duty
- 1.0 Service Factor (except as noted)
- UL Recognized and CSA Certified



C-Face Footed (Rigid Base)

HP	RPM	VOLTS	FRAME	CAT. NO.	MODEL NO.	STOCK	LIST PRICE	MULT. SYMB.	NOM. EFF.	F.L. AMPS	WEIGHT	"C" DIM.	FOOT NOTES
5	3600	230	184JM	Z433A	184TBFW7315	✓	\$917	S2	82.5	19.2	89	18.59	13
7 1/2	3600	230	213JM	Z434	213TBFW7010	✓	\$1,231	S2	81.5	32.0	90	20.59	68
10	3600	230	215JM	Z435	215TBFW7010	✓	\$1,500	S2	85.5	41.5	236	22.09	18

PUMP MOTORS (FLUID HANDLING)

Close-Coupled Pump, JM, Three Phase

Drip-proof, C-Face Footless (Vertical) and C-Face Footed (Rigid Base)

Applications:

Close-coupled pumps where the pump impeller is mounted directly on the motor shaft in environments that are relatively clean and dry.



Features:

- NEMA JM pump shaft dimensions
- JMV frame includes drip cover for vertical mount without base
- JM frame has rigid base, drip cover not included
- Ball bearings, mechanically locked on shaft end
- Continuous duty
- 1.15 Service Factor
- UL Recognized and CSA Certified
- UL Listed for Fire Pump applications (except as noted)



Suitable for use on VFD per guidelines on page 17.

HP	RPM	VOLTS	FRAME	CAT. NO.	MODEL NO.	STOCK	LIST PRICE	MULT. SYMB.	NOM. EFF.	F.L. AMPS	WEIGHT	"C" DIM.	FOOT NOTES	
1	1800	200	143JM	E115	143TTDR4040		\$354	S2	82.5	3.6	41	14.62		
	1800	200	143JMV	E117	143TTDR4041		\$395	S2	82.5	3.6	40	14.92	27	
	1800	208-230/460	143JM	M301	143TTDR5336	✓	\$283	S2	77.0	3.5-3.6/1.8	28	13.12	d,68	
	1800	208-230/460	143JMV	M302	143TTDR5334	✓	\$324	S2	77.0	3.5-3.6/1.8	27	13.42	d,27,68	
	1800	230/460	143JM	E100	143TTDR4035	✓	\$354	S2	82.5	3.1/1.55	44	14.62	68	
	1800	230/460	143JMV	E118	143TTDR4034	✓	\$395	S2	82.5	3.1/1.55	40	14.92	27,68	
	1800	575	143JM	E116	143TTDR4047		\$354	S2	82.5	1.1	36	14.62		
	1800	575	143JMV	E119	143TTDR4046		\$395	S2	82.5	1.1	40	14.92	27	
1 1/2	3600	200	143JM	E120	143TTDR4016		\$404	S2	82.5	5.5	32	13.12	1,13	
	3600	200	143JMV	E122	143TTDR4017		\$445	S2	82.5	5.5	32	12.92	27	
	3600	208-230/460	143JM	M303	143TTDR5309	✓	\$323	S2	80.0	4.9-5.0/2.5	27	13.12	d,68	
	3600	230/460	143JM	E123	143TTDR4009	✓	\$404	S2	82.5	4.8/2.4	28	13.12	68	
	3600	208-230/460	143JMV	E095	143TTDR14004		\$445	S2	82.5	5.2-5.0/2.5	42	12.92	27,68	
	3600	575	143JM	E121	143TTDR4022		\$404	S2	82.5	1.9	28	13.12		
	3600	575	143JMV	E124	143TTDR4024		\$445	S2	82.5	1.9	36	12.92	27	
	1800	200	145JM	E125	145TTDR4040		\$386	S2	84.0	5.0	41	14.62		
	1800	200	145JMV	E127	145TTDR4041		\$429	S2	84.0	5.0	39	14.92	27	
	1800	208-230/460	145JMV	M306	145TTDR5346	✓	\$349	S2	80.0	4.8-4.8/2.4	30	13.42	d,27,68	
	1800	230/460	145JM	E102	145TTDR4034	✓	\$386	S2	84.0	4.4/2.2	44	14.62	68	
	1800	230/460	145JMV	E128	145TTDR4035	✓	\$429	S2	84.0	4.4/2.2	39	14.92	27,68	
	1800	575	145JM	E126	145TTDR4072		\$386	S2	84.0	1.8	41	14.62		
	1800	575	145JMV	E129	145TTDR4047		\$429	S2	84.0	1.8	40	14.92	27	
	2	3600	200	145JM	E130	145TTDR4015		\$454	S2	84.0	6.2	43	13.12	
		3600	200	145JMV	E132	145TTDR4016		\$496	S2	84.0	6.2	32	13.42	27
3600		208-230/460	145JM	M307	145TTDR5313	✓	\$362	S2	80.0	6.4-6.2/3.1	29	13.12	d,68	
3600		208-230/460	145JMV	M308	145TTDR5314	✓	\$404	S2	80.0	6.4-6.2/3.1	28	12.92	d,27,68	
3600		208-230/460	145JM	E096	145TTDR4317	✓	\$454	S2	84.0	5.6-5.4/2.7	33	13.12	68	
3600		230/460	145JMV	E133	145TTDR4010	✓	\$496	S2	84.0	5.4/2.7	44	13.42	27,68	
3600		575	145JM	E131	145TTDR4021		\$454	S2	84.0	2.2	32	13.12		
3600		575	145JMV	E134	145TTDR4022		\$496	S2	84.0	2.2	32	13.42	27	
1800		200	145JM	E135	145TTDR4066		\$404	S2	84.0	6.7	45	15.12		
1800		200	145JMV	E137	145TTDR4067		\$445	S2	84.0	6.7	42	15.42	27	
1800		208-230/460	145JMV	M310	145TTDR5350	✓	\$364	S2	81.5	6.2-6.4/3.2	36	14.42	d,27,68	
1800		230/460	145JM	E104	145TTDR4060	✓	\$404	S2	84.0	5.8/2.9	48	15.12	68	
1800		230/460	145JMV	E138	145TTDR4051	✓	\$445	S2	84.0	5.8/2.9	44	15.42	27,68	
1800		575	145JM	E136	145TTDR4046		\$404	S2	84.0	2.3	45	15.12		
1800		575	145JMV	E139	145TTDR4073		\$445	S2	84.0	2.3	43	15.42	27	

Catalog numbers (Cat No.) highlighted in bold blue have efficiency levels that meet EISA requirements

Continued on next page.



Close-Coupled Pump, JM, Three Phase

Drip-proof, C-Face Footless (Vertical) and C-Face Footed (Rigid Base)

HP	RPM	VOLTS	FRAME	CAT. NO.	MODEL NO.	STOCK	LIST PRICE	MULT. SYMB.	NOM. EFF.	F.L. AMPS	WEIGHT	"C" DIM.	FOOT NOTES	
3	3600	200	145JM	E140	145TTDR4115		\$507	S2	84.0	10	34	13.62		
	3600	200	145JMV	E142	145TTDR4307		\$549	S2	84.0	10	34	13.92	27	
	3600	208-230/460	145JM	M311	145TTDR5315	✓	\$406	S2	84.0	8.9-8.4/4.2	34	13.62	68	
	3600	208-230/460	145JMV	M312	145TTDR5316	✓	\$448	S2	84.0	8.9-8.4/4.2	33	13.92	27,68	
	3600	230/460	145JM	E105	145TTDR4303		\$507	S2	84.0	8.4/4.2	26	13.62	68	
	3600	230/460	145JMV	E143	145TTDR4110		\$549	S2	84.0	8.4/4.2	34	13.92	27,68	
	3600	575	145JM	E141	145TTDR4121		\$507	S2	84.0	3.5	34	13.62		
	3600	575	145JMV	E144	145TTDR4025		\$549	S2	84.0	3.5	33	13.92	27	
	1800	200	182JM	E145	182TTDR4140		\$471	S2	86.5	9.4	70	17.09		
	1800	200	182JMV	E147	182TTDR4036		\$555	S2	86.5	9.9	78	18.87	27	
	1800	208-230/460	182JM	M313	182TTDB7355	✓	\$395	S2	80.0	9.6-10/5.0	75	13.87	d,68,98	
	1800	208-230/460	182JM	E097	182TTDW14029	✓	\$471	S2	86.5	8.8/4.4	83	14.82	13,68,98	
	1800	230/460	182JM	E106A	182TTDW4336	✓	\$471	S2	86.5	9.0-8.8/4.4	70	14.82	13,68	
	1800	230/460	182JMV	E098	182TTDW4006	✓	\$555	S2	85.5	9.0-8.8/4.4	64	18.78	27,68,98	
	1800	230/460	182JMV	E148A	182TTDW4135	✓	\$555	S2	86.5	8.8/4.4	64	18.78	27,68	
	1800	575	182JM	E146	182TTDR4146		\$471	S2	86.5	3.45	89	16.09		
	1800	575	182JMV	E149A	182TTDW4147		\$555	S2	86.5	3.5	87	18.28	27	
	5	3600	200	182JM	E150	182TTDR4116		\$608	S2	86.5	13.8	75	16.09	13
3600		200	182JMV	E152	182TTDR4117		\$690	S2	86.5	13.8	78	16.68	27	
3600		208-230/460	182JM	M1315	182TTDB7325	✓	\$503	S2	85.5	13.6-12.4/6.2	88	14.82	13,68,98	
3600		208-230/460	182JMV	M1316	182TTDB7601	✓	\$590	S2	85.5	13.6-12.4/6.2	74	19.24	27,68,98	
3600		230/460	182JM	E107A	182TTDW4325	✓	\$608	S2	85.5	14-12.4/6.2	87	14.82	13	
3600		230/460	182JMV	E153A	182TTDW4304	✓	\$690	S2	85.5	12.4/6.2	78	18.78	27	
3600		575	182JM	E151	182TTDR4122		\$608	S2	86.5	4.8	79	16.09	13	
3600		575	182JMV	E154	182TTDR4123		\$690	S2	86.5	4.8	73	16.68	27	
1800		200	184JM	E155	184TTDR4140		\$608	S2	87.5	15.1	78	16.59		
1800		200	184JMV	E157	184TTDR4141		\$690	S2	87.5	14.5	78	19.37	27	
1800		208-230/460	184JM	M317	184TTDB7357	✓	\$487	S2	86.5	14.4-13.6/6.8	58	16.35	d,68,98	
1800		208-230/460	184JM	M1317	184TTDW7357	✓	\$608	S2	87.5	14.6-13.2/6.6	78	14.82	68,98	
1800		230/460	184JM	E108	184TTDR4034		\$608	S2	87.5	13.2/6.6	75	17.09	13	
1800		230/460	184JMV	E158A	184TTDW4135	✓	\$690	S2	87.5	13.2/6.6	78	15.72	27,68	
1800		575	184JM	E156	184TTDR4146		\$608	S2	87.5	5.3	89	17.59	13	
1800		575	184JMV	E159	184TTDR4147		\$690	S2	87.5	5.2	83	19.37	27	
7 1/2		3600	200	184JM	E160	184TTDR4115		\$731	S2	87.5	20.2	87	17.09	13
		3600	200	184JMV	E162	184TTDR4116		\$815	S2	87.5	20.2	89	19.87	27
	3600	230/460	184JM	E109A	184TTDW14001	✓	\$731	S2	87.5	17.6/8.8	89	15.82	13,68,98	
	3600	230/460	184JMV	E163A	184TTDW4005	✓	\$815	S2	87.5	17.6/8.8	90	15.82	27,68,98	
	3600	575	184JM	E161	184TTDR4121		\$731	S2	87.5	7.2	90	17.09	13	
	3600	575	184JMV	E164	184TTDR4122		\$815	S2	87.5	7.2	98	17.68	27	

Catalog numbers (Cat No.) highlighted in bold blue have efficiency levels that meet EISA requirements

Continued on next page.

Close-Coupled Pump, JM, Three Phase

Dripproof, C-Face Footless (Vertical) and C-Face Footed (Rigid Base)

HP	RPM	VOLTS	FRAME	CAT. NO.	MODEL NO.	STOCK	LIST PRICE	MULT. SYMB.	NOM. EFF.	F.L. AMPS	WEIGHT	"C" DIM.	FOOT NOTES
7 1/2	1800	200	213JM	E165	213TTDW4042		\$686	S2	88.5	22.1	118	19.16	
	1800	200	213JMV	E167	213TTDW4033		\$772	S2	88.5	22.1	96	20.44	27
	1800	208-230/460	213JM	M321	213TTDBA7047	✓	\$703	S2	87.5	22.0-20.4/10.2	100	17.66	d,68,98
	1800	208-230/460	213JMV	M1322	213TTDBA7048	✓	\$815	S2	84.0	22.0-21.6/10.8	68	18.94	d,27,68,98
	1800	230/460	213JM	E110	213TTDW4047	✓	\$879	S2	88.5	19.2/9.6	100	19.16	68
	1800	230/460	213JMV	E168	213TTDW4048	✓	\$772	S2	88.5	19.2/9.6	121	20.44	27,68
	1800	575	213JM	E166	213TTDW4041		\$686	S2	88.5	7.6	120	19.16	
	1800	575	213JMV	E169	213TTDW4038		\$990	S2	88.5	7.7	142	20.44	27
10	3600	200	213JM	E170	213TTDW4009		\$940	S2	88.5	26.9	131	19.16	
	3600	200	213JMV	E172	213TTDW4008		\$1,049	S2	88.5	26.9	112	20.44	27
	3600	208-230/460	213JM	M323	213TTDW7022	✓	\$751	S2	85.5	28.0-25.0/12.5	96	17.66	d,68
	3600	208-230/460	213JM	M1323	213TTDBA7022	✓	\$751	S2	85.5	28.0-25.0/12.5	111	17.66	d,68,98
	3600	208-230/460	213JMV	M324	213TTDW7023	✓	\$861	S2	85.5	28.0-25.0/12.5	90	18.94	d,27,68
	3600	230/460	213JM	E111	213TTDW4022	✓	\$940	S2	88.5	23.4/11.7	135	19.16	68
	3600	230/460	213JMV	E173	213TTDW4023	✓	\$1,049	S2	88.5	23.4/11.7	132	20.44	27
	3600	575	213JM	E171	213TTDW4010		\$940	S2	88.5	9.3	153	19.16	
	3600	575	213JMV	E174	213TTDW4007		\$1,049	S2	88.5	9.3	125	20.44	27
	1800	200	215JM	E175	215TTDW4041		\$1,043	S2	89.5	28.7	124	19.16	68,98
	1800	200	215JMV	E177	215TTDW4043		\$1,152	S2	89.5	28.7	128	20.44	27,68
	1800	208-230/460	215JM	M325	215TTDBA7047	✓	\$834	S2	88.5	28.4-26.4/13.2	150	19.16	d,68
	1800	208-230/460	215JMV	M326	215TTDW7048	✓	\$945	S2	87.5	29.2-26.4/13.2	132	20.44	d,27,68
	1800	230/460	215JM	E112	215TTDW4047	✓	\$1,043	S2	89.5	25.0/12.5	135	19.16	68
	1800	230/460	215JMV	E178	215TTDW4048	✓	\$1,152	S2	89.5	25.0/12.5	135	20.44	27
	1800	575	215JM	E176	215TTDW4042		\$1,043	S2	89.5	10.0	125	19.16	13
1800	575	215JMV	E179	215TTDW4032		\$1,152	S2	89.5	10.0	118	20.44	27	
15	3600	200	215JM	E180	215TTDW4008		\$1,161	S2	90.2	39.0	128	20.41	13
	3600	200	215JMV	E182	215TTDW4010		\$1,272	S2	90.2	39.0	160	21.69	27
	3600	208-230/460	215JM	M327	215TTDW7022	✓	\$928	S2	86.5	42.0-38.0/19.0	134	19.16	d,68
	3600	208-230/460	215JMV	M328	215TTDW7023	✓	\$1,040	S2	86.5	42.0-38.0/19.0	102	20.44	d,27,68
	3600	230/460	215JM	E113	215TTDW4022	✓	\$1,161	S2	90.2	34.0/17.0	131	20.41	13
	3600	230/460	215JMV	E183	215TTDW4023	✓	\$1,272	S2	90.2	34.0/17.0	127	21.69	27,68
	3600	575	215JM	E181	215TTDW4009		\$1,161	S2	90.2	13.6	159	20.41	13
	3600	575	215JMV	E184	215TTDW4007		\$1,272	S2	90.2	13.6	127	21.69	27
	1800	200	254JM	E185	254TTDX4343		\$1,410	S2	91.0	44.0	268	24.17	13
	1800	200	254JMV	E187	254TTDX4345		\$1,571	S2	91.0	44.2	263	25.45	27
	1800	208-230/460	254JM	E114A	254TTDX14062	✓	\$1,410	S2	91.0	115/208-230	248	24.17	68
	1800	208-230/460	254JMV	M353	254TTDX7046	✓	\$1,287	S2	87.5	43.0-39.2/19.6	155	23.70	d,27
	1800	230/460	254JMV	E188	254TTDX4039	✓	\$1,571	S2	91.0	38.5/19.2	220	25.45	27,68
	1800	575	254JM	E186	254TTDX4344		\$1,043	S2	91.0	15.3	200	24.17	27
20	3600	200	254JM	E190	254TTDX4007		\$1,161	S2	91.0	53.1	204	24.17	
	3600	200	254JMV	E193	254TTDX4015		\$1,625	S2	91.0	53.1	185	23.70	27
	3600	208-230/460	254JM	M330	254TTDX7008	✓	\$1,171	S2	88.5	52.6-47.0/23.5	156	22.42	d,68
	3600	230/460	254JM	E191	254TTDX4006	✓	\$1,465	S2	91.0	46.0/23.1	213	22.42	
	3600	230/460	254JMV	E194	254TTDX4020		\$1,625	S2	91.0	46.0/23.1	187	23.70	27,68
	3600	575	254JM	E192	254TTDX4019		\$1,465	S2	91.0	18.5	225	22.42	
	3600	575	254JMV	E195	254TTDX4024		\$1,625	S2	91.0	18.5	178	23.70	27

Catalog numbers (Cat No.) highlighted in bold blue have efficiency levels that meet EISA requirements

Continued on next page.

PUMP MOTORS (FLUID HANDLING)



Close-Coupled Pump, JM, Three Phase

Drip-proof, C-Face Footless (Vertical) and C-Face Footed (Rigid Base)

HP	RPM	VOLTS	FRAME	CAT. NO.	MODEL NO.	STOCK	LIST PRICE	MULT. SYMB.	NOM. EFF.	F.L. AMPS	WEIGHT	"C" DIM.	FOOT NOTES
20	1800	200	256JMV	E199	256TTDX4329		\$1,860	S2	91.0	60.0	235	25.45	27
	1800	208-230/460	256JM	M331	256TTDX7074	✓	\$1,361	S2	88.5	56.4-53.0/26.5	230	24.17	d,68
	1800	230/460	256JM	E197	256TTDX4075	✓	\$1,702	S2	91.0	52.0/26	128	24.17	68
	1800	230/460	256JMV	U100	256TTDX4041		\$1,860	S2	91.0	50.0/25	196	25.45	27,68
	1800	575	256JM	E198	256TTDX4326		\$1,702	S2	91.0	20.8	238	24.17	
	1800	575	256JMV	U101	256TTDX4047		\$1,860	S2	91.0	20.8	188	25.45	27
25	3600	200	256JM	U102	256TTDX4021		\$1,723	S2	91.0	66.5	225	24.17	
	3600	208-230/460	256JM	M332	256TTDX7011	✓	\$1,378	S2	89.5	66.0-61.0/30.5	175	24.17	d,68
	3600	230/460	256JM	U103	256TTDX4006	✓	\$1,723	S2	91.0	58.0/29	126	24.17	68
	3600	575	256JM	U104	256TTDX4019		\$1,723	S2	91.0	23.2	196	24.17	
	1800	208	284JM	U105	284TTDP4043		\$2,058	S2	91.7	67.5	358	24.31	
	1800	230/460	284JM	M333	284TTDP7338	✓	\$1,647	S2	87.5	66.0/33.0	330	24.31	d,68
30	1800	230/460	284JM	U106	284TTDP4069	✓	\$2,058	S2	91.7	61.0/30.5	360	24.31	68
	1800	575	284JM	U107	284TTDP4037		\$2,058	S2	91.0	24.5	360	24.31	68
	3600	200	284JM	U108	284TTDP4025		\$2,101	S2	91.0	83.0	295	24.31	
	3600	230/460	284JM	U109A	284TTDP14009	✓	\$2,101	S2	91.0	72./36.0	346	24.31	
	3600	575	284JM	U110	284TTDP4023		\$2,101	S2	91.0	28.8	315	24.31	
	1800	200	286JM	U111	286TTDP4067		\$2,377	S2	92.4	83.0	410	25.81	
40	1800	230/460	286JM	U112	286TTDP4037	✓	\$2,377	S2	92.4	72.0/36.0	385	25.81	68
	1800	575	286JM	U113	286TTDP4047		\$2,377	S2	92.4	28.8	385	25.81	d,68
	3600	230/460	286JM	U114	286TTDP4015	✓	\$2,629	S2	91.7	94.0/47.0	575	25.81	
	3600	575	286JM	U115	286TTDP4021		\$2,629	S2	91.7	38.0	386	25.81	
	1800	230/460	324JM	U116	324TTDP4345		\$3,106	S2	93.0	97.0/48.5	340	26.25	68
	50	3600	230/460	324JM	U118	324TTDP4004	✓	\$3,364	S2	92.4	117/58.5	460	26.25
50	3600	230/460	324JM	M358	324TTDP7320	✓	\$2,868	S2	89.5	124/62.0	393	26.25	d
	3600	575	324JM	U119	324TTDP4018		\$3,364	S2	92.4	47.0	460	26.25	
	1800	230/460	326JM	U120	326TTDP4329		\$3,587	S2	93.0	123/61.5	525	27.75	68
	1800	575	326JM	U121	326TTDP4326		\$3,587	S2	93.0	47.5	525	27.75	

Catalog numbers (Cat No.) highlighted in bold blue have efficiency levels that meet EISA requirements

Blue shaded areas are Cast Iron Frames

Continued on next page.

Globetrotter® NEMA Premium® Efficiency Close Coupled Pump, JM, Three Phase

Dripproof, C-Face Footed (Rigid Base)

Features:

- ⚡ Meets or exceeds NEMA Premium® efficiencies
NEMA Premium® models are in compliance with EISA2007
- 143TC-145TC models steel frame, 182TC-236TC models cast iron frame and brackets
- Inverter Duty 10:1 Variable Torque and 2:1 Constant Torque, 1.0 SF
- 1.15 Service Factor
- Class F Insulation
- Standard assembly F1, reversible to F2 assembly
- UL Recognized, CSA Certified, CE Mark
- Two year warranty



HP	RPM	VOLTS	FRAME	CAT. NO.	MODEL NO.	STOCK	LIST PRICE	MULT. SYMB.	NOM. EFF.	F.L. AMPS	WEIGHT	"C" DIM.	FOOT NOTES
1	1800	208-230/460	143JM	GT0401	143TTDR6030	✓	\$415	S2	85.5	2.5-3.2/1.6	41	14.62	27
	1800	575	143JM	GT0501	143TTDR6031	✓	\$415	S2	85.5	1.2	41	14.62	d,68
1 1/2	3600	208-230/460	143JM	GT0403	143TTDR6007	✓	\$474	S2	84.0	4.4-4.0/2.0	40	13.12	68
	3600	575	143JM	GT0503	143TTDR6008	✓	\$474	S2	84.0	1.7	40	13.12	27,68
	1800	208-230/460	145JM	GT0404	145TTDR6034	✓	\$452	S2	86.5	4.8-5.6/2.4	44	14.62	
	1800	575	145JM	GT0504	145TTDR6031	✓	\$452	S2	86.5	1.8	44	14.62	27
2	3600	208-230/460	145JM	GT0406	145TTDR6007	✓	\$532	S2	85.5	5.2-4.8/2.4	43	13.12	
	3600	575	145JM	GT0506	145TTDR6004	✓	\$532	S2	85.5	2.0	43	13.12	d,68
	1800	208-230/460	145JM	GT0407	145TTDR6036	✓	\$512	S2	86.5	6.0-5.8/2.9	45	15.12	68
	1800	575	145JM	GT0507	145TTDR6030	✓	\$512	S2	86.5	2.5	45	15.12	
3	3600	208-230/460	145JM	GT0409	145TTDR6013	✓	\$595	S2	86.5	8.0-7.2/3.6	47	13.62	
	3600	575	145JM	GT0509	145TTDR6006	✓	\$595	S2	86.5	2.8	47	13.62	d,68
	1800	208-230/460	182JM	GT0410	182TTDB6032	✓	\$566	S2	89.5	8.4-7.8/3.9	123	15.35	68
	1800	575	182JM	GT0510	182TTDB6033	✓	\$566	S2	89.5	3.1	123	15.35	68
5	3600	208-230/460	182JM	GT0412	182TTDB6007	✓	\$715	S2	86.5	13.2-11.8/5.9	131	15.35	
	3600	575	182JM	GT0512	182TTDB6008	✓	\$715	S2	86.5	4.7	131	15.35	
	1800	208-230/460	184JM	GT0413	184TTDB6032	✓	\$687	S2	89.5	13.6-12.4/6.2	135	16.34	
	1800	575	184JM	GT0513	184TTDB6033	✓	\$687	S2	89.5	5.0	135	16.34	
7 1/2	3600	208-230/460	184JM	GT0415	184TTDB6007	✓	\$858	S2	88.5	19.0-17.2/8.6	149	16.34	68
	3600	575	184JM	GT0515	184TTDB6008	✓	\$858	S2	88.5	6.9	149	16.34	d,68
	1800	208-230/460	213JM	GT0416	213TTDB6032	✓	\$1,047	S2	91.0	20.4-18.6/9.3	166	17.68	
	1800	575	213JM	GT0516	213TTDB6033	✓	\$1,047	S2	91.0	7.5	166	17.68	
10	3600	208-230/460	213JM	GT0418	213TTDB6007	✓	\$1,106	S2	89.5	25.5-23/11.5	156	17.68	68
	3600	575	213JM	GT0518	213TTDB6008	✓	\$1,106	S2	89.5	9.2	156	17.68	
	1800	208-230/460	215JM	GT0419	215TTDB6032	✓	\$1,225	S2	91.7	26.9-24.4/12.2	229	19.17	d
	1800	575	215JM	GT0519	215TTDB6033	✓	\$1,225	S2	91.7	9.8	229	19.17	
15	3600	208-230/460	215JM	GT0421	215TTDB6007	✓	\$1,366	S2	90.2	38.0-34.0/17.0	191	19.17	68
	3600	575	215JM	GT0521	215TTDB6008	✓	\$1,366	S2	90.2	13.6	191	19.17	
	1800	208-230/460	254JM	GT0422	254TTDCA6032	✓	\$1,646	S2	93.0	208-230/460	322	24.41	
	1800	575	254JM	GT0522	254TTDCA6033	✓	\$1,646	S2	93.0	15.2	322	24.41	

Catalog numbers (Cat No.) highlighted in bold blue have efficiency levels that meet EISA requirements

Blue shaded areas are Cast Iron Frames

Continued on next page.



Globetrotter® NEMA Premium® Efficiency, Close Coupled Pump, JM, Three Phase

Drip-proof, C-Face Footed (Rigid Base)

HP	RPM	VOLTS	FRAME	CAT. NO.	MODEL NO.	STOCK	LIST PRICE	MULT. SYMB.	NOM. EFF.	F.L. AMPS	WEIGHT	"C" DIM.	FOOT NOTES
20	3600	208-230/460	254JM	GT0424	254TTDCA6007	✓	\$1,705	S2	91.0	51.0-46.0/23.0	312	24.41	d,68
	3600	575	254JM	GT0524	254TTDCA6008	✓	\$1,705	S2	91.0	18.4	312	24.41	68
	1800	208-230/460	256JM	GT0425	256TTDCA6032	✓	\$2,021	S2	93.0	53.0-49.0/24.5	374	26.00	68
	1800	575	256JM	GT0525	256TTDCA6033	✓	\$2,021	S2	93.0	19.6	374	26.00	
25	3600	208-230/460	256JM	GT0427	256TTDCA6007	✓	\$2,062	S2	91.7	64.0-57.0/28.5	328	26.00	
	3600	575	256JM	GT0527	256TTDCA6008	✓	\$2,062	S2	91.7	22.8	328	26.00	
	1800	208-230/460	284JM	GT0428	284TTDCA6032	✓	\$2,412	S2	93.6	66.0-62.0/31.0	441	26.58	
	1800	575	284JM	GT0528	284TTDCA6033	✓	\$2,412	S2	93.6	24.8	441	26.58	68
30	3600	208-230/460	284JM	GT0430	284TTDCA6007	✓	\$2,462	S2	91.7	76.0-68.0/34.0	412	26.58	d,68
	3600	575	284JM	GT0530	284TTDCA6008	✓	\$2,462	S2	91.7	27.2	412	26.58	
	1800	208-230/460	286JM	GT0431	286TTDCA6032	✓	\$2,786	S2	94.1	81.0-74.0/37.0	502	27.10	
	1800	575	286JM	GT0531	286TTDCA6033	✓	\$2,786	S2	94.1	29.6	502	27.10	68
40	3600	208-230/460	286JM	GT0433	286TTDCA6007	✓	\$3,082	S2	92.4	100-90.0/45.0	470	27.10	
	3600	575	286JM	GT0533	286TTDCA6008	✓	\$3,082	S2	92.4	36.0	470	27.10	d
	1800	208-230/460	324JM	GT0434	324TTDCA6032	✓	\$3,640	S2	94.1	105-95.0/47.5	604	28.95	
	1800	575	324JM	GT0534	324TTDCA6033	✓	\$3,640	S2	94.1	40.4	604	28.95	68
50	3600	208-230/460	324JM	GT0436	324TTDCA6007	✓	\$3,943	S2	93.0	124-113/56.5	570	28.95	
	3600	575	324JM	GT0536	324TTDCA6008	✓	\$3,943	S2	93.0	45.0	570	28.95	
	1800	208-230/460	326JM	GT0437	326TTDCA6032	✓	\$4,205	S2	94.5	131-118/59.0	738	30.12	
	1800	575	326JM	GT0537	326TTDCA6033	✓	\$4,205	S2	94.5	47.0	738	30.12	

Catalog numbers (Cat No.) highlighted in bold blue have efficiency levels that meet EISA requirements

Blue shaded areas are Cast Iron Frames

Close-Coupled Pump, JM

Three Phase, Totally Enclosed

Applications:

Close-coupled pumps where the pump impeller is mounted directly on the motor shaft in damp, dusty, or dirty environments.

Features:

- NEMA JM pump shaft dimensions
- Ball bearings, mechanically locked on shaft end
- Continuous duty
- 1.15 Service Factor (except as noted)
- UL Recognized and CSA Certified



C- Face Footed (Rigid Base)

Suitable for use on VFD per guidelines on page 17.

HP	RPM	VOLTS	FRAME	CAT. NO.	MODEL NO.	STOCK	LIST PRICE	MULT. SYMB.	NOM. EFF.	F.L. AMPS	WEIGHT	"C" DIM.	FOOT NOTES	
1	1800	200	143JM	U300	143TTFR4040		\$439	S2	82.5	3.5	35	15.00		
	1800	230/460	143JM	U301	143TTFR4034	✓	\$439	S2	82.5	3.0/1.5	35	15.00		
	1800	575	143JM	U302	143TTFR4046		\$439	S2	82.5	1.2	35	15.00	68	
1 1/2	3600	200	143JM	U303	143TTFR4015		\$516	S2	82.5	4.6	31	15.00	27,68	
	3600	208-230/460	143JM	U304A	143TTFR4303	✓	\$516	S2	82.5	4.4-4.0/2.0	31	14.50	68	
	3600	575	143JM	U305	143TTFR4021		\$516	S2	82.5	1.6	31	15.00		
	1800	200	145JM	U306	145TTFR4048		\$481	S2	84.0	5.1	45	16.50		
	1800	230/460	145JM	U307	145TTFR4045	✓	\$481	S2	84.0	4.4/2.2	46	16.50	68	
	1800	575	145JM	U308	145TTFR4054		\$481	S2	84.0	1.8	45	16.50		
2	3600	200	145JM	U309	145TTFR4017		\$559	S2	84.0	6.0	39	15.50		
	3600	208-230/460	145JM	U310A	145TTFR14011	✓	\$559	S2	84.0	5.6-5.2/2.6	39	15.50		
	3600	575	145JM	U311	145TTFR4023		\$559	S2	84.0	2.1	39	15.50		
	1800	200	145JM	U312	145TTFR4050		\$503	S2	84.0	6.4	48	16.00		
	1800	208-230/460	145JM	U313A	145TTFR14045	✓	\$503	S2	84.0	6.6-6.2/3.1	48	16.00		
	1800	575	145JM	U314	145TTFR4128		\$503	S2	84.0	2.2	48	16.00		
3	3600	208-230/460	145JM	U363	145TTFR4310	✓	\$590	S2	85.5	8.4-8.0/4.0	59	15.00	68	
	3600	200	182JM	U315	182TTFR4015		\$641	S2	85.5	8.5	81	17.35	13	
	3600	230/460	182JM	U316A	182TTFW4302	✓	\$641	S2	85.5	8.2-7.4/3.7	89	17.35	13	
	3600	575	182JM	U317	182TTFR4021		\$641	S2	85.5	2.95	81	17.35	13	
	1800	208-230/460	182JM	U319A	182TTFW4330	✓	\$586	S2	87.5	8-8.6/4.3	72	16.59	13	
	1800	575	182JM	U320	182TTFR4056		\$586	S2	87.5	3.35	79	18.35	13	
5	3600	230/460	184JM	U322A	184TTFW4009	✓	\$761	S2	87.5	12.2/6.1	118	16.09	13	
	3600	575	184JM	U323	184TTFR4021		\$761	S2	87.5	4.9	82	18.35	13	
	1800	208-230/460	184JM	U325A	184TTFW4760	✓	\$708	S2	87.5	14.0-13.0/6.5	82	15.59	13	
	1800	575	184JM	U326A	184TTFW14028		\$761	S2	87.5	5.2	89	15.59	13	
	7 1/2	3600	200	213JM	U327	213TTFW4009		\$949	S2	88.5	21.1	125	22.09	
	3600	208-230/460	184JM	U360	184TTFW4915	✓	\$718	S2	88.5	17.6-16.8/8.4	127	18.09	13,17,68	
	3600	230/460	213JM	U329	213TTFW4022	✓	\$949	S2	88.5	18.4/9.2	113	22.09	68	
	3600	575	213JM	U331	213TTFW4010		\$949	S2	88.5	7.3	147	22.09	68	
	1800	230/460	213JM	U334	213TTFW4047	✓	\$1,085	S2	89.5	20.0/10.0	131	20.59	68	
	1800	575	213JM	U335	213TTFW4038		\$1,085	S2	89.5	8	225	20.59	68	

PUMP MOTORS (FLUID HANDLING)

Catalog numbers (Cat No.) highlighted in bold blue have efficiency levels that meet EISA requirements

Continued on next page.



Close-Coupled Pump, JM

Three Phase, Totally Enclosed

C-Face Footed (Rigid Base)

HP	RPM	VOLTS	FRAME	CAT. NO.	MODEL NO.	STOCK	LIST PRICE	MULT. SYMB.	NOM. EFF.	F.L. AMPS	WEIGHT	"C" DIM.	FOOT NOTES
10	3600	200	215JM	U336	215TTFW4014		\$1,161	S2	89.5	27.6	128	22.09	
	3600	230/460	215JM	U337	215TTFW4022	✓	\$1,161	S2	89.5	24.0/12.0	142	22.09	68
	3600	575	215JM	U338	215TTFW4015		\$1,161	S2	89.5	9.6	158	22.09	
	1800	200	215JM	U339	215TTFW4035		\$1,298	S2	89.5	29.9	130	22.09	
	1800	230/460	215JM	U340	215TTFW4047	✓	\$1,298	S2	89.5	25.6/12.8	135	22.09	
	1800	575	215JM	U341	215TTFW4036		\$1,298	S2	89.5	10.4	128	22.09	
15	3600	208-230/460	215JM	U357	215TTFW14301	✓	\$1,182	S2	90.2	39.0-36.0/18.0	151	22.09	68
	3600	230/460	254JM	U344	254TTFL4006	✓	\$1,451	S2	91.0	35.0/17.5	138	24.74	AL,68
	3600	575	254JM	U346	254TTFL4010		\$1,451	S2	90.2	14.0	563	24.74	AL
	1800	200	254JM	U347	254TTFL4034		\$1,760	S2	91.0	46.0	225	24.74	AL
	1800	230/460	254JM	U348	254TTFL4031	✓	\$1,760	S2	91.0	40.0/20.0	224	24.74	AL,68
	1800	575	254JM	U349	254TTFL4036		\$1,760	S2	91.0	16.0	220	24.74	AL
20	3600	200	256JM	U350	256TTFL4010		\$1,953	S2	90.2	54.1	425	26.49	AL
	3600	230/460	256JM	U351	256TTFL4006	✓	\$1,953	S2	90.2	47.0/23.5	425	26.49	AL,68
	3600	575	256JM	U352	256TTFL4012		\$1,953	S2	90.2	18.8	425	26.49	AL
	1800	200	256JM	U353	256TTFL4036		\$2,136	S2	91.0	58.7	321	28.49	AL
	1800	230/460	256JM	U354	256TTFL4031	✓	\$2,136	S2	91.0	51.0/25.5	321	28.49	AL,68
	1800	575	256JM	U355	256TTFL4038		\$2,136	S2	91.0	20.4	321	28.49	AL

Close-Coupled Pump, JP

Single Phase, Dripproof

Applications:

Close-coupled pumps where the pump impeller is mounted directly on the motor shaft in environments that are relatively clean and dry.

Features:

- NEMA JP pump shaft dimensions
- Ball bearings, mechanically locked on shaft end
- Capacitor start design for high starting torque
- Capacitor start / capacitor run design for higher efficiency, as noted
- Continuous duty
- 1.15 Service Factor
- UL Recognized and CSA Certified



C-Face Footed (Rigid Base)

HP	RPM	VOLTS	FRAME	CAT. NO.	MODEL NO.	STOCK	LIST PRICE	MULT. SYMB.	NOM. EFF.	F.L. AMPS	WEIGHT	"C" DIM.	FOOT NOTES
1	1800	115/208-230	143JP	Z420	143TCDR5330		\$395	S2	72.0	13.4/6.8-6.7	35	16.68	95
1 1/2	1800	115/208-230	145JP	Z422	145TCDR5329		\$475	S2	77.0	18.6/9.9-9.3	43	17.68	95
2	1800	115/230	182JP	Z424	182TCDR7354		\$605	S2	72.0	23.0/11.5	78	19.15	13
3	3600	115/230	182JP	Z425	182TCDR8005		\$605	S2	74.0	32.0/16.0	87	18.65	13
	1800	115/230	184JP	Z426	184TCDR7626		\$707	S2	75.5	33.0/16.5	94	20.65	13
5	3600	230	184JP	Z427A	184TBDW17011	✓	\$886	S2	80.0	22.0	89	19.46	d,13
	1800	230	213JP	Z428	213TCDW7028		\$972	S2	78.5	28.0	130	23.79	95
7 1/2	3600	230	213JP	Z429	213TCDW7003	✓	\$1,106	S2	78.5	37.0	118	22.29	95
	1800	230	215JP	Z430	215TBDW7045		\$1,343	S2	84.0	34.5	132	23.79	1,95
10	3600	230	215JP	Z431	215TCDW7004	✓	\$1,423	S2	81.5	47.0	135	23.79	95
	1800	230	215JP	Z432	215TBDW7030		\$1,628	S2	82.5	44.0	325	25.04	1,95

Catalog numbers (Cat No.) highlighted in bold blue have efficiency levels that meet EISA requirements

Continued on next page.

Close-Coupled Pump, JP, Three Phase

Dripproof, C-Face Footless (Vertical) and C-Face Footed (Rigid Base)

Applications:

Close-coupled pumps where the pump impeller is mounted directly on the motor shaft in environments that are relatively clean and dry.

Features:

- NEMA JP pump shaft dimensions
- JPV frame includes drip cover for vertical mount without base
- JP frame has rigid base, drip cover not included
- Ball bearings, mechanically locked on shaft end
- Continuous duty
- 1.15 Service Factor
- UL Recognized and CSA Certified
- UL Listed for Fire Pump applications (except as noted)



Suitable for use on VFD per guidelines on page 17.

HP	RPM	VOLTS	FRAME	CAT. NO.	MODEL NO.	STOCK	LIST PRICE	MULT. SYMB.	NOM. EFF.	F.L. AMPS	WEIGHT	"C" DIM.	FOOT NOTES
1	1800	200	143JP	U122	143TTDR4042		\$354	S2	82.5	3.6	41	17.68	95
	1800	200	143JPV	U125	143TTDR4043		\$395	S2	82.5	3.6	41	17.98	27
	1800	208-230/460	143JP	U123A	143TTDR14048		\$354	S2	82.5	3.3-3.1/1.6	41	17.68	68
	1800	230/460	143JPV	U126	143TTDR4037		\$395	S2	82.5	3.1/1.6	41	17.98	68
	1800	575	143JP	U124	143TTDR4048		\$354	S2	82.5	1.1	42	17.68	13
	1800	575	143JPV	U127	143TTDR4049		\$395	S2	82.5	1.1	42	17.98	27
1 1/2	3600	200	143JP	U128	143TTDR4018		\$404	S2	82.5	5.5	46	16.18	95
	3600	200	143JPV	U131	143TTDR4019		\$445	S2	82.5	5.5	45	15.98	27
	3600	208-230/460	143JP	U129A	143TTDR4003	✓	\$404	S2	82.5	4.9-5.0/2.5	46	16.18	68
	3600	230/460	143JPV	U132	143TTDR4011		\$445	S2	82.5	4.8/2.4	46	15.98	27
	3600	575	143JP	U130	143TTDR4023		\$404	S2	82.5	1.9	47	16.18	1,95
	3600	575	143JPV	U133	143TTDR4025		\$445	S2	82.5	1.9	47	15.98	27
	1800	200	145JP	U134	145TTDR4042		\$386	S2	84.0	5.0	47	17.68	
	1800	200	145JPV	U137	145TTDR4043		\$429	S2	84.0	5.0	47	17.98	27
	1800	208-230/460	145JP	M105	145TTDR5354	✓	\$309	S2	80.0	4.8-4.8/2.4	32	16.18	d,68
	1800	208-230/460	145JP	U135A	145TTDR4354	✓	\$386	S2	84.0	4.6-4.4/2.2	47	17.68	68
	1800	230/460	145JPV	U138	145TTDR4037		\$429	S2	84.0	4.4/2.2	41	17.98	27,68
	2	3600	200	145JP	U140	145TTDR4017		\$364	S2	84.0	6.2	45	16.18
3600		200	145JPV	U143	145TTDR4018		\$496	S2	84.0	6.2	45	16.48	27
3600		230/460	145JP	U141	145TTDR4011		\$454	S2	84.0	5.4/2.7	45	16.18	68
3600		230/460	145JPV	U144	145TTDR4012		\$496	S2	84.0	5.4/2.7	45	16.48	27,68
3600		575	145JP	U142	145TTDR4023		\$454	S2	84.0	2.2	45	16.18	
3600		575	145JPV	U145	145TTDR4024		\$496	S2	84.0	2.2	45	16.48	27
1800		200	145JP	U146	145TTDR4068		\$404	S2	84.0	6.7	45	18.18	
1800		200	145JPV	U149	145TTDR4069		\$445	S2	84.0	6.7	45	18.48	27
1800		208-230/460	145JP	M109	145TTDR5356	✓	\$323	S2	81.5	6.2-6.2/3.1	37	17.18	68
1800		208-230/460	145JP	U147A	145TTDR4356	✓	\$404	S2	84.0	6.2-5.8/2.9	44	17.98	68
1800		208-230/460	145JPV	U150A	145TTDR4355		\$445	S2	84.0	6.2-5.8/2.9	44	17.98	27,68
1800		575	145JP	U148	145TTDR4074		\$404	S2	84.0	2.3	44	18.18	
1800	575	145JPV	U151	145TTDR4075		\$445	S2	84.0	2.3	44	18.48	27	

Catalog numbers (Cat No.) highlighted in bold blue have efficiency levels that meet EISA requirements

Continued on next page.



Close-Coupled Pump, JP, Three Phase

Dripproof, C-Face Footless (Vertical) and C-Face Footed (Rigid Base)

HP	RPM	VOLTS	FRAME	CAT. NO.	MODEL NO.	STOCK	LIST PRICE	MULT. SYMB.	NOM. EFF.	F.L. AMPS	WEIGHT	"C" DIM.	FOOT NOTES	
3	3600	200	145JP	U152	145TTDR4117		\$507	S2	84.0	10.0	43	16.68		
	3600	200	145JPV	U155	145TTDR4118		\$549	S2	84.0	10.0	43	16.98	27	
	3600	208-230/460	145JP	M111	145TTDR5319	✓	\$406	S2	84.0	8.9-8.4/4.2	36	16.68	d,68	
	3600	230/460	145JP	U153	145TTDR4111	✓	\$507	S2	84.0	8.4/4.2	42	16.68	68	
	3600	230/460	145JPV	U156	145TTDR4112		\$549	S2	84.0	8.4/4.2	45	16.98	27,68	
	3600	575	145JP	U154	145TTDR4123		\$507	S2	84.0	3.5	46	16.68		
	3600	575	145JPV	U157	145TTDR4124		\$549	S2	84.0	3.5	45	16.98	27	
	1800	200	182JP	U158	182TTDR4142		\$471	S2	86.5	9.4	51	19.66	13	
	1800	200	182JPV	U161	182TTDR4143		\$555	S2	86.5	9.4	52	19.91	27	
	1800	208-230/460	182JP	M170	182TTDR5338	✓	\$377	S2	84.0	9.2-8.6/4.3	60	19.65	d,13,68	
	1800	208-230/460	182JP	U159A	182TTDW4338		\$471	S2	86.5	9.0-8.8/4.4	70	17.46	13,68	
	1800	230/460	182JPV	U162	182TTDR4048		\$555	S2	86.5	8.6/4.3	102	19.84	13,27	
	1800	575	182JP	U160	182TTDR4148		\$471	S2	86.5	3.45	103	19.66	13	
	1800	575	182JPV	U163	182TTDR4149		\$555	S2	86.5	3.45	102	19.91	13,27	
	5	3600	200	182JP	U164	182TTDR4118		\$608	S2	86.5	13.8	78	19.16	13
		3600	200	182JPV	U167	182TTDR4119		\$690	S2	86.5	13.8	81	19.84	13,27
		3600	208-230/460	182JP	U165A	182TTDW14011	✓	\$608	S2	85.5	14.0-12.4/6.2	97	17.96	68
		3600	230/460	182JPV	U168	182TTDR4113		\$690	S2	86.5	12.0/6.0	85	19.84	27
3600		575	182JP	U166	182TTDR4124		\$608	S2	86.5	4.8	76	19.16	13	
3600		575	182JPV	U169	182TTDR4125		\$690	S2	86.5	4.8	72	19.84	13,27	
1800		200	184JP	U170	184TTDR4142		\$608	S2	87.5	14.5	74	20.41	13	
1800		200	184JPV	U173	184TTDR4143		\$690	S2	87.5	14.5	72	20.84	27	
1800		208-230/460	184JP	M115A	184TTDW7358	✓	\$487	S2	87.5	16.0-14.8/7.4	74	17.88	13,68	
1800		208-230/460	184JPV	M163	184TTDR8039		\$572	S2	82.5	14.5-13.4/6.7	74	19.84	27,68,98	
1800		208-230/460	184JPV	U299	184TTDW4039		\$690	S2	87.5	14.5-13.2/6.6	87	21.66	27,68,98	
1800		230/460	184JP	U171A	184TTDW4136		\$608	S2	87.5	12.6/6.3	54	20.41	13	
1800		575	184JP	U172	184TTDR4148		\$608	S2	87.5	5.3	69	20.16	13	
1800		575	184JPV	U175	184TTDR4149		\$690	S2	87.5	5.0	72	20.84	27	
7 1/2		3600	200	184JP	U176	184TTDR4117		\$731	S2	87.5	20.7	72	20.16	13
		3600	200	184JPV	U179	184TTDR4118		\$815	S2	87.5	20.2	72	20.84	27
		3600	208-230/460	184JP	M116	184TTDR7604	✓	\$584	S2	84.5	21.0-19.4/9.7	72	19.41	d,68,98
		3600	208-230/460	184JP	U177A	184TTDW14079	✓	\$731	S2	87.5	20.0-17.6/8.8	131	18.88	13,68
	3600	230/460	184JPV	U180	184TTDR4112		\$815	S2	87.5	17.6/8.8	131	20.32	27	
	3600	575	184JP	U178	184TTDR4123		\$731	S2	87.5	7.2	131	20.16	13	
	3600	575	184JPV	U181	184TTDR4124		\$815	S2	87.5	7.2	136	20.32	27	
	1800	200	213JP	U182	213TTDW4044		\$879	S2	88.5	22.1	137	23.03		
	1800	200	213JPV	U185	213TTDW4051		\$990	S2	88.5	22.1	123	24.31	27	
	1800	208-230/460	213JP	M117	213TTDW7049	✓	\$703	S2	84.0	22.0-21.6/10.8	111	21.53	d,68	
	1800	230/460	213JP	U183	213TTDW4049	✓	\$879	S2	88.5	19.2/9.6	141	23.03	68	
	1800	230/460	213JPV	U186A	213TTDW14059		\$990	S2	88.5	19.4/9.2	141	23.03	27,68	
1800	575	213JP	U184	213TTDW4039		\$879	S2	88.5	7.6	138	23.03			
1800	575	213JPV	U187	213TTDW4052		\$990	S2	88.5	7.7	140	24.31	27		

Catalog numbers (Cat No.) highlighted in bold blue have efficiency levels that meet EISA requirements

Continued on next page.

PUMP MOTORS (FLUID HANDLING)

Close-Coupled Pump, JP, Three Phase

Drip-proof, C-Face Footless (Vertical) and C-Face Footed (Rigid Base)

HP	RPM	VOLTS	FRAME	CAT. NO.	MODEL NO.	STOCK	LIST PRICE	MULT. SYMB.	NOM. EFF.	F.L. AMPS	WEIGHT	"C" DIM.	FOOT NOTES	
10	3600	200	213JP	U188	213TTDW4011		\$940	S2	88.5	26.9	130	23.03		
	3600	200	213JPV	U191	213TTDW4013		\$1,049	S2	88.5	26.9	130	24.31	27	
	3600	208-230/460	213JP	M118	213TTDW7024	√	\$751	S2	85.5	28.0-25.0/12.5	130	21.53	d,68	
	3600	208-230/460	213JP	U189A	213TTDW14013	√	\$940	S2	88.5	26.0-23.4/11.7	132	23.03	68	
	3600	230/460	213JPV	U192	213TTDW4025		\$1,049	S2	88.5	23.4/11.7	134	24.31	27,68	
	3600	575	213JP	U190	213TTDW4012		\$940	S2	88.5	9.4	135	23.03		
	3600	575	213JPV	U193	213TTDW4014		\$1,049	S2	88.5	9.3	130	24.31	27	
	1800	200	215JP	U194	215TTDW4044		\$1,043	S2	89.5	28.8	156	23.03		
	1800	200	215JPV	U197	215TTDW4053		\$1,152	S2	89.5	28.8	163	24.31	27	
	1800	208-230/460	215JP	M119	215TTDW7049	√	\$834	S2	87.5	29.0-26.4/13.2	115	23.03	d,68	
	1800	208-230/460	215JPV	M167	215TTDW7050		\$945	S2	87.5	29.2-26.4/13.2	141	24.31	27,68	
	1800	230/460	215JP	U195	215TTDW4049	√	\$1,043	S2	89.5	25.0/12.5	225	23.03	68	
	1800	208-230/460	215JPV	U198A	215TTDW14073		\$1,152	S2	89.5	28.0-25.0/12.5	225	24.38	27,68	
	1800	575	215JP	U196	215TTDW4051		\$1,043	S2	89.5	10.0	135	23.03		
	1800	575	215JPV	U199	215TTDW4052		\$1,152	S2	89.0	10.0	137	24.31	27	
	15	3600	200	215JP	U200	215TTDW4011		\$1,161	S2	90.2	39.0	138	24.28	13,27
		3600	200	215JPV	U203	215TTDW4013		\$1,272	S2	90.2	39.1	139	25.56	27
		3600	208-230/460	215JPV	M168	215TTDW7025		\$1,040	S2	91.0	39.0-35.0/17.5	129	24.31	27,68
3600		230/460	215JP	U201A	215TTDW14020	√	\$1,161	S2	90.2	34.0/17.0	220	24.28	68	
3600		230/460	215JPV	U204	215TTDW4025		\$1,272	S2	90.2	34.0/17.0	135	25.56	27,68	
3600		575	215JP	U202	215TTDW4012		\$1,161	S2	90.2	13.6	168	24.28		
3600		575	215JPV	U205	215TTDW4014		\$1,272	S2	90.2	13.6	215	25.56	27	
1800		200	254JP	U206	254TTDX4074		\$1,410	S2	91.0	44.0	220	27.04		
1800		200	254JPV	U209	254TTDX4060		\$1,571	S2	91.0	44.0	198	28.33	27	
1800		208-230/460	254JP	M121	254TTDX7042	√	\$1,128	S2	87.5	43.0-39.2/19.6	158	25.29	d,68	
1800		208-230/460	254JPV	M122	254TTDX7043	√	\$1,287	S2	87.5	43.0-39.2/19.6	174	26.58	d,27	
1800		230/460	254JP	U207	254TTDX4075	√	\$1,410	S2	91.0	38.5/19.2	214	27.04		
1800		230/460	254JPV	U210	254TTDX4041	√	\$1,571	S2	91.0	38.5/19.2	224	28.33	27	
1800		575	254JP	U208	254TTDX4340		\$1,410	S2	91.0	15.4	260	27.04		
1800		575	254JPV	U211	254TTDX4341		\$1,571	S2	91.0	15.4	220	28.33	27	
20		3600	200	254JP	U212	254TTDX4014		\$1,465	S2	91.0	53.1	200	25.29	d,68,98
		3600	200	254JPV	U215	254TTDX4010		\$1,625	S2	91.0	53.1	200	26.58	27
		3600	230/460	254JP	U213	254TTDX4017	√	\$1,465	S2	91.0	46.0/23.1	213	25.29	
	3600	230/460	254JPV	U216	254TTDX4012		\$1,625	S2	91.0	46.0/23.1	150	26.58	27,68	
	3600	575	254JP	U214	254TTDX4008		\$1,465	S2	91.0	18.0	203	25.29		
	3600	575	254JPV	U217	254TTDX4016		\$1,625	S2	91.0	18.5	200	26.58	27	
	1800	200	256JP	U218	256TTDX4064		\$1,702	S2	91.0	60.0	225	27.04		
	1800	200	256JPV	U221	256TTDX4065		\$1,860	S2	91.0	59.8	235	28.33	27	
	1800	230/460	256JP	U219	256TTDX4063	√	\$1,702	S2	91.0	52.0/26.0	328	27.04	68	
	1800	575	256JP	U220	256TTDX4328		\$1,702	S2	91.0	20.8	136	27.04		
	1800	575	256JPV	U223	256TTDX4059		\$1,860	S2	91.0	20.8	220	28.33	27	
	25	3600	200	256JP	U224	256TTDX4022		\$1,723	S2	91.0	66.7	235	27.04	27
3600		230/460	256JP	U225	256TTDX4004	√	\$1,723	S2	91.0	58.0/29.0	185	27.04	68	
3600		575	256JP	U226	256TTDX4023		\$1,723	S2	91.0	23.2	255	27.04		

Catalog numbers (Cat No.) highlighted in bold blue have efficiency levels that meet EISA requirements

Continued on next page.

PUMP MOTORS (FLUID HANDLING)



Close-Coupled Pump, JP, Three Phase

Dripproof, C-Face Footed (Rigid Base)

HP	RPM	VOLTS	FRAME	CAT. NO.	MODEL NO.	STOCK	LIST PRICE	MULT. SYMB.	NOM. EFF.	F.L. AMPS	WEIGHT	"C" DIM.	FOOT NOTES
25	1800	200	284JP	U227	284TTDP4044		\$2,058	S2	91.7	70.0	420	27.18	
	1800	230/460	284JP	M126	284TTDP7072	✓	\$1,647	S2	87.5	66.0/33.0	306	27.18	d,68
	1800	230/460	284JP	U228A	284TTDP14044	✓	\$2,058	S2	91.7	61.0/30.5	310	27.18	68
	1800	575	284JP	U229	284TTDP4045		\$2,058	S2	91.7	24.5	348	27.18	
30	3600	200	284JP	U230	284TTDP4011		\$2,101	S2	91.0	83.0	361	27.18	27,68
	3600	230/460	284JP	M127	284TTDP7302	✓	\$1,679	S2	88.5	73.0/36.5	305	27.18	d,68
	3600	230/460	284JP	U231	284TTDP4022	✓	\$2,101	S2	91.0	72.0/36.0	368	27.18	68
	3600	575	284JP	U232	284TTDP4012		\$2,101	S2	91.0	29.0	428	27.18	
	1800	200	286JP	U233	286TTDP4048		\$2,377	S2	92.4	83.0	330	28.68	
	1800	230/460	286JP	M128	286TTDP7054	✓	\$1,859	S2	89.5	79.0/39.5	331	28.68	d,68
	1800	230/460	286JP	U234	286TTDP4074	✓	\$2,377	S2	92.4	72.0/36.0	331	28.68	68
	1800	575	286JP	U235	286TTDP4049		\$2,377	S2	92.4	28.8	425	28.68	
	40	3600	230/460	286JP	M129	286TTDP7018	✓	\$2,104	S2	88.5	100/50.0	350	28.68
3600	230/460	286JP	U236	286TTDP4020	✓	\$2,629	S2	91.7	94.0/47.0	428	28.68	68	
3600	575	286JP	U237	286TTDP4024		\$2,629	S2	91.7	38.0	327	28.68		
1800	230/460	324JP	U238	324TTDP4348	✓	\$3,106	S2	93.0	97.0/48.5	487	29.12	68	
1800	230/460	324JP	M130	324TTDP7073	✓	\$2,484	S2	89.5	106/53.0	563	29.12	d,68	
1800	575	324JP	U239	324TTDP4033		\$3,106	S2	93.0	39.0	474	29.12		
50	3600	230/460	324JP	U240	324TTDP4002	✓	\$3,364	S2	92.4	117/58.5	478	29.12	68
	3600	575	324JP	U241	324TTDP4011		\$3,385	S2	92.4	47.0	424	29.12	
	1800	230/460	326JP	M131	326TTDP7330	✓	\$2,868	S2	90.2	130/65.0	427	30.62	d,68
	1800	230/460	326JP	U242	326TTDP4340	✓	\$3,587	S2	93.0	123/61.5	585	30.62	68
	1800	575	326JP	U243	326TTDP4032		\$3,587	S2	93.0	49.0	490	30.62	

Catalog numbers (Cat No.) highlighted in bold blue have efficiency levels that meet EISA requirements

Blue shaded areas are Cast Iron Frames

Close-Coupled Pump, JP, Three Phase

Totally Enclosed, C-Face Footed (Rigid Base)

Applications:

Close-coupled pumps where the pump impeller is mounted directly on the motor shaft in damp, dusty, or dirty environments.



Features:

- **More ratings available, contact Marathon for price and availability**
- NEMA JP pump shaft dimensions
- Ball bearings, mechanically locked on shaft end
- Continuous duty
- 1.15 Service Factor
- UL Recognized and CSA Certified



Suitable for use on VFD per guidelines on page 17.

HP	RPM	VOLTS	FRAME	CAT. NO.	MODEL NO.	STOCK	LIST PRICE	MULT. SYMB.	NOM. EFF.	F.L. AMPS	WEIGHT	"C" DIM.	FOOT NOTES
7 1/2	3600	200	213JP	U328	213TTFW4011		\$949	S2	89.5	21.2	96	25.96	95
	3600	208-230/460	184JP	M216	184TTFR8914	✓	\$671	S2	85.5	20.0-19.0/9.5	84	21.91	d,68
	3600	208-230/460	184JP	U372	184TTFW4914	✓	\$767	S2	88.5	17.6-16.8/8.4	90	21.20	13,68
	3600	575	213JP	U332	213TTFW4012		\$949	S2	89.5	7.4	98	25.96	13
15	3600	200	254JP	U343	254TTFL4009		\$1,451	S2	91.0	40.3	197	27.60	AL
	3600	208-230/460	215JP	U366	215TTFW14302		\$1,182	S2	90.2	40.0-37.0/18.5	193	25.96	68
	3600	208-230/460	254JP	M213	254TTFL5003	✓	\$1,161	S2	85.5	41.0-36.0/18.0	173	27.60	d,AL,68
	3600	230/460	254JP	U345A	254TTFL14008		\$1,451	S2	91.0	35.0/17.5	173	27.55	AL,68
	3600	575	254JP	U356	254TTFL4011		\$1,451	S2	91.0	14.0	173	27.60	AL

Catalog numbers (Cat No.) highlighted in bold blue have efficiency levels that meet EISA requirements

Globetrotter® NEMA Premium® Efficiency Close-Coupled Pump, JP, Three Phase Dripproof, C-Face Footed (Rigid Base)

Features:

✦ Meets or exceeds NEMA Premium® efficiencies NEMA Premium® models are in compliance with EISA2007

- 143TC-145TC models steel frame, 182TC-236TC models cast iron frame and brackets
- Inverter Duty 10:1 Variable Torque and 2:1 Constant Torque, 1.0 SF
- 1.15 Service Factor
- Class F Insulation
- Standard assembly F1, reversible to F2 assembly
- UL Recognized, CSA Certified, CE Mark
- Two year warranty
- Nameplated 60/50 hertz, 190/380 volts at next lower HP



HP	RPM	VOLTS	FRAME	CAT. NO.	MODEL NUMBER	STOCK	LIST PRICE	MULT. SYMB.	NOM. EFF.	F.L. AMPS	WEIGHT	"C" DIM.	FOOT NOTES
1	1800	230/460	143JP	GT2401	143TTDR16048	✓	\$415	S2	85.5	2.5-3.2/1.6	41	14.62	
	1800	575	143JP	GT2501	143TTDR16040	✓	\$415	S2	85.5	1.2	41	14.62	
1-1/2	3600	230/460	143JP	GT2403	143TTDR16015	✓	\$474	S2	84.0	4.4-4.0/2.0	40	13.12	
	3600	575	143JP	GT2503	143TTDR16006	✓	\$474	S2	84.0	1.7	40	13.12	
	1800	230/460	145JP	GT2404	145TTDR16330	✓	\$452	S2	86.5	4.8-5.6/2.4	44	14.62	
	1800	575	145JP	GT2504	145TTDR16327	✓	\$452	S2	86.5	1.8	44	14.62	
2	3600	230/460	145JP	GT2406	145TTDR16020	✓	\$532	S2	85.5	5.2-4.8/2.4	43	13.12	
	3600	575	145JP	GT2506	145TTDR16017	✓	\$532	S2	85.5	2.0	43	13.12	
	1800	230/460	145JP	GT2407	145TTDR16333	✓	\$512	S2	86.5	6.0-5.8/2.9	45	15.12	
	1800	575	145JP	GT2507	145TTDR16339	✓	\$512	S2	86.5	2.5	45	15.12	
3	3600	230/460	145JP	GT2409	145TTDR16301	✓	\$595	S2	86.5	8.0-7.2/3.6	47	13.62	
	3600	575	145JP	GT2509	145TTDR16303	✓	\$595	S2	86.5	2.8	47	13.62	
	1800	230/460	182JP	GT2410	182TTDB6037	✓	\$566	S2	89.5	8.4-7.8/3.9	123	15.35	
	1800	575	182JP	GT2510	182TTDB6038	✓	\$566	S2	89.5	3.1	123	15.35	
5	3600	230/460	182JP	GT2412	182TTDB6012	✓	\$715	S2	86.5	13.2-11.8/5.9	131	15.35	
	3600	575	182JP	GT2512	182TTDB6013	✓	\$715	S2	86.5	4.7	131	15.35	
	1800	230/460	184JP	GT2413	184TTDB6037	✓	\$687	S2	89.5	13.6-12.4/6.2	135	16.34	
	1800	575	184JP	GT2513	184TTDB6038	✓	\$687	S2	89.5	5.0	135	16.34	
7-1/2	3600	230/460	184JP	GT2415	184TTDB6012	✓	\$858	S2	88.5	19.0-17.2/8.6	149	16.34	
	3600	575	184JP	GT2515	184TTDB6013	✓	\$858	S2	88.5	6.9	149	16.34	
	1800	230/460	213JP	GT2416	213TTDB6037	✓	\$1,047	S2	91.0	20.4-18.6/9.3	166	17.68	
	1800	575	213JP	GT2516	213TTDB6038	✓	\$1,047	S2	91.0	7.5	166	17.68	
10	3600	230/460	213JP	GT2418	213TTDB6012	✓	\$1,106	S2	89.5	25.5-23/11.5	156	17.68	
	3600	575	213JP	GT2518	213TTDB6013	✓	\$1,106	S2	89.5	9.2	156	17.68	
	1800	230/460	215JP	GT2419	215TTDB6037	✓	\$1,225	S2	91.7	26.9-24.4/12.2	229	19.17	
	1800	575	215JP	GT2519	215TTDB6038	✓	\$1,225	S2	91.7	9.8	229	19.17	
15	3600	230/460	215JP	GT2421	215TTDB6012	✓	\$1,366	S2	90.2	38.0-34.0/17.0	191	19.17	
	3600	575	215JP	GT2521	215TTDB6013	✓	\$1,366	S2	90.2	13.6	191	19.17	
	1800	230/460	254JP	GT2422	254TTDCA6037	✓	\$1,646	S2	93.0	208-230/460	322	24.41	
	1800	575	254JP	GT2522	254TTDCA6038	✓	\$1,646	S2	93.0	15.2	322	24.41	

Catalog numbers (Cat No.) highlighted in bold blue have efficiency levels that meet EISA requirements

Blue shaded areas are Cast Iron Frames

Continued on next page.



Globetrotter® NEMA Premium® Efficiency Close-Coupled Pump, JP, Three Phase

Dripproof, C-Face Footed (Rigid Base)

HP	RPM	VOLTS	FRAME	CAT. NO.	MODEL NUMBER	STOCK	LIST PRICE	MULT. SYMB.	NOM. EFF.	F.L. AMPS	WEIGHT	"C" DIM.	FOOT NOTES
20	3600	230/460	254JP	GT2424	254TTDCA6012	✓	\$1,705	S2	91.0	51.0-46.0/23.0	312	24.41	
	3600	575	254JP	GT2524	254TTDCA6013	✓	\$1,705	S2	91.0	18.4	312	24.41	
	1800	230/460	256JP	GT2425	256TTDCA6037	✓	\$2,021	S2	93.0	53.0-49.0/24.5	374	26.00	
	1800	575	256JP	GT2525	256TTDCA6038	✓	\$2,021	S2	93.0	19.6	374	26.00	
25	3600	230/460	256JP	GT2427	256TTDCA6012	✓	\$2,062	S2	91.7	64.0-57.0/28.5	328	26.00	
	3600	575	256JP	GT2527	256TTDCA6013	✓	\$2,062	S2	91.7	22.8	328	26.00	
	1800	230/460	284JP	GT2428	284TTDCA6037	✓	\$2,412	S2	93.6	66.0-62.0/31.0	441	26.58	
	1800	575	284JP	GT2528	284TTDCA6038	✓	\$2,412	S2	93.6	24.8	441	26.58	
30	3600	230/460	284JP	GT2430	284TTDCA6012	✓	\$2,462	S2	91.7	76.0-68.0/34.0	412	26.58	
	3600	575	284JP	GT2530	284TTDCA6013	✓	\$2,462	S2	91.7	27.2	412	26.58	
	1800	230/460	286JP	GT2431	286TTDCA6037	✓	\$2,786	S2	94.1	81.0-74.0/37.0	502	27.10	
	1800	575	286JP	GT2531	286TTDCA6038	✓	\$2,786	S2	94.1	29.6	502	27.10	
40	3600	230/460	286JP	GT2433	286TTDCA6012	✓	\$3,082	S2	92.4	100-90.0/45.0	470	27.10	
	3600	575	286JP	GT2533	286TTDCA6013	✓	\$3,082	S2	92.4	36.0	470	27.10	
	1800	230/460	324JP	GT2434	324TTDCA6037	✓	\$3,640	S2	94.1	105-95.0/47.5	604	28.95	
	1800	575	324JP	GT2534	324TTDCA6038	✓	\$3,640	S2	94.1	40.4	604	28.95	
50	3600	230/460	324JP	GT2436	324TTDCA6012	✓	\$3,943	S2	93.0	124-113/56.5	570	28.95	
	3600	575	324JP	GT2536	324TTDCA6013	✓	\$3,943	S2	93.0	45.0	570	28.95	
	1800	230/460	326JP	GT2437	326TTDCA6037	✓	\$4,205	S2	94.5	131-118/59.0	738	30.12	
	1800	575	326JP	GT2537	326TTDCA6038	✓	\$4,205	S2	94.5	47.0	738	30.12	

Catalog numbers (Cat No.) highlighted in bold blue have efficiency levels that meet EISA requirements

Blue shaded areas are Cast Iron Frames

Dimensions

Definite Purpose - Close Coupled Pump Motors

Typical Close Coupled Pump Motor

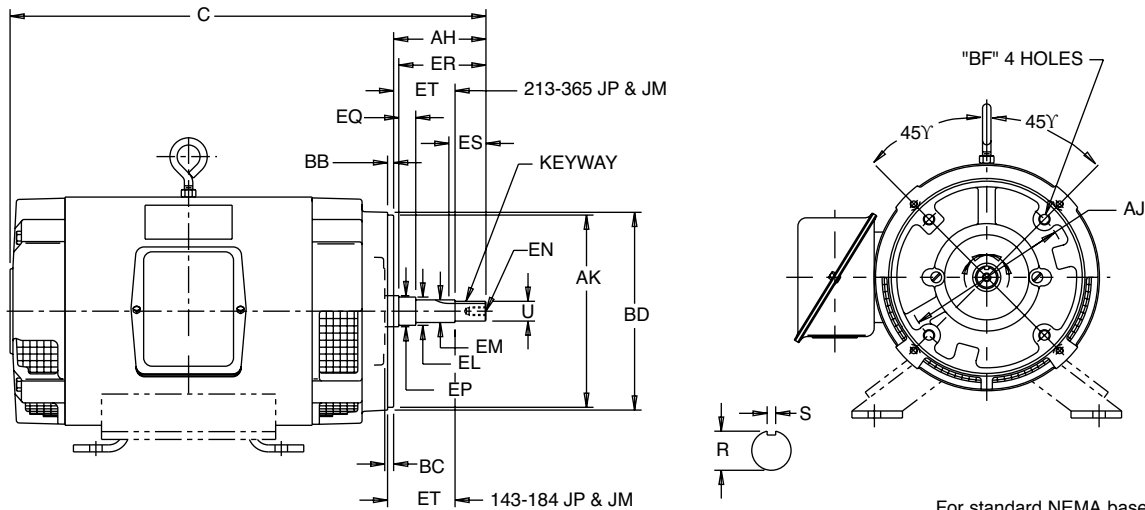

For standard NEMA base dimensions, see chart on back cover

Dimensions for Type JM

Frame Desig.	U	AH	AJ	AK	BB	BD Max.	BF			EL	EM	EN			EP Min.	EQ	ER Min.	Keyseat			ET
							No.	Tap Size	Bolt Pen. Allow.			Tap Size	Tap Drill Depth Max.	Bolt Pen. Allow.				R	ES Min.	S	
143 & 145	0.8745	4.15	5.890	4.500	0.150	6.62	4	3/8-16	0.56	1.156	1.0000	3/8-16	1.12	0.75	1.156	0.640	4.25	0.771	1.65	0.190	2.890
182 & 184	0.8745	4.13	5.89	4.500	0.16	6.62	4	3/8-16	0.56	1.250	1.0000	3/8-16	1.12	0.75	1.250	0.640	4.25	0.771	1.65	0.190	2.890
213 & 215	0.8750	4.25	7.265	8.500	0.312	9.00	4	1/2-13	0.75	1.250	1.0000	3/8-16	1.12	0.75	1.750	0.640	4.25	0.771	1.65	0.190	2.890
254 & 256	1.2495	5.25	7.250	8.500	0.312	10.00	4	1/2-13	0.75	1.750	1.3750	1/2-13	1.50	1.00	1.750	0.640	5.25	1.112	2.53	0.252	3.015
284 & 286	1.2495	5.281	11.00	12.500	0.312	14.00	4	5/8-11	0.94	1.750	1.3750	1/2-13	1.50	1.00	2.125	0.645	5.25	1.112	2.53	0.252	3.020
324 & 326	1.2495	5.281	11.00	12.500	0.312	14.00	4	5/8-11	0.94	1.750	1.3750	1/2-13	1.50	1.00	2.125	0.645	5.25	1.112	2.53	0.252	3.020
	1.2490	5.219	11.00	12.495	0.250					1.748	1.3745				0.610		1.097	2.53	0.250	2.985	
	1.2490	5.219	11.00	12.495	0.250					1.748	1.3745				0.605		1.097	2.53	0.250	2.980	
	1.2490	5.219	11.00	12.495	0.250					1.478	1.3745				0.605		1.097	2.53	0.250	2.980	

Dimensions for Type JP

Frame Desig.	U	AH	AJ	AK	BB	BD Max.	BF			EL	EM	EN			EP Min.	EQ	ER Min.	Keyseat			ET
							No.	Tap Size	Bolt Pen. Allow.			Tap Size	Tap Drill Depth Max.	Bolt Pen. Allow.				R	ES Min.	S	
143 & 145	0.8745	7.19	5.890	4.500	0.156	6.62	4	3/8-16	0.56	1.156	1.0000	3/8-16	1.12	0.75	1.156	1.578	7.312	0.771	1.65	0.190	5.952
182 & 184	0.8745	7.21	5.890	4.500	0.156	6.62	4	3/8-16	0.56	1.250	1.0000	3/8-16	1.12	0.75	1.250	1.548	7.312	0.771	1.65	0.190	5.952
213 & 215	1.2495	8.12	7.250	8.500	0.312	9.00	4	1/2-13	0.75	1.750	1.3750	1/2-13	1.50	1.00	1.750	2.390	8.125	1.112	2.53	0.252	5.890
254 & 256	1.2495	8.156	7.250	8.500	0.312	10.00	4	1/2-13	0.75	1.750	1.3750	1/2-13	1.50	1.00	1.750	2.360	8.125	1.112	2.53	0.252	5.890
284 & 286	1.2495	8.156	11.00	12.500	0.312	14.00	4	5/8-11	0.94	1.750	1.3750	1/2-13	1.50	1.00	2.125	2.390	8.125	1.112	2.53	0.252	5.895
324 & 326	1.2495	8.12	11.00	12.500	0.312	14.00	4	5/8-11	0.94	1.750	1.3750	1/2-13	1.50	1.00	2.125	2.360	8.125	1.112	2.53	0.250	5.860
	1.2490	8.094	11.00	12.495	0.250					1.748	1.3745				2.360		1.097	2.53	0.250	5.855	
	1.2490	8.094	11.00	12.495	0.250					1.748	1.3745				2.360		1.097	2.53	0.250	5.855	
	1.2490	8.12	11.00	12.495	0.250					1.748	1.3745				2.355		1.097	2.53	0.250	5.855	
364 & 365	1.6245	8.12	11.00	12.500	0.312	14.00	4	5/8-11	0.94	2.125	1.7500	1/2-13	1.50	1.00	2.500	2.395	8.125	1.416	2.53	0.377	5.895
	1.6240			12.495	0.250					2.13	1.7495				2.355		1.401	2.53	0.375	5.855	

PUMP MOTORS (FLUID HANDLING)

All dimensions are measured in inches. For "C" dimensions, refer to the appropriate catalog page. Certified drawings are available upon request - contact Marathon Electric for details.



Fire Pump, Three Phase

Dripproof, Rigid Base

Applications:

For use on pumps designed for fire pump duty and installed per NFPA-20. These Dripproof motors are intended for installation in relatively clean and dry environments. **Fire Pump motors are not recommended for use with variable frequency drives.**



Features:

- UL File EX5190, CSA File LR2025
- Ball bearings
- 1.15 Service Factor
- Red paint on 25 HP through 200 HP
- NEMA Design B, Code G or less
- Dual voltage motors have 12 leads, suitable for wye-delta or across the line start on either voltage, or part winding start on low voltage
- Single voltage motors have 12 leads and are suitable for wye-delta, across the line, or part winding start
- Will accept C- Face kits, see Accessories section
- 230/460 and 460 Volt models rated for 50 HZ at next lower HP, 1.15 SF as noted

HP	RPM	VOLTS	FRAME	CAT. NO.	MODEL NO.	STOCK	LIST PRICE	MULT. SYMB.	NOM. EFF.	F.L. AMPS	WEIGHT	"C" DIM.	FOOT NOTES
25	3600	200/400	256T	U501	256TTDX4020		\$1,750	E2	91.0	66.5/33.5	126	22.32	95
	3600	230/460	256T	U500	256TTDX4024		\$1,750	E2	91.0	58.0/29.0	164	22.32	68
1800	200/400	284T	U503	284TTDP4047			\$1,733	E2	91.7	70/35.0	420	23.49	
	230/460	284T	U502	284TTDP4027			\$1,733	E2	91.7	61.0/30.5	423	23.49	68
30	3600	200/400	284TS	Y625	284TSTDP8618		\$1,613	E2	88.5	84.0/42.0	247	22.06	AL
	3600	230/460	284TS	U504	284TSTDP4002		\$2,088	E2	91.0	72.0/36.0	460	22.06	68
3600	230/460	284TS	U505	284TSTDP4007			\$2,088	E2	91.0	83/41.5	460	22.06	68
	1800	200/400	286T	U507	286TTDP14042		\$2,016	E2	92.4	83.0/41.5	331	24.99	68
1800	230/460	286T	U506	286TTDP4041			\$2,016	E2	92.4	72.0/36.0	331	24.99	68
	3600	200/400	286TS	U509	286TSTDP4023	√	\$2,672	E2	91.7	108/54.0	360	23.56	AL
3600	230/460	286TS	U508	286TSTDP4022		√	\$2,672	E2	91.7	94.0/47.0	332	23.56	68
	1800	200/400	324T	U511	324TTDP14049		\$2,507	E2	93.0	112/56.0	465	26.00	
1800	230/460	324T	U510	324TTDP4038			\$2,507	E2	93.0	97.0/48.5	465	26.00	68
	3600	200/400	324TS	U513	324TSTDP4007	√	\$3,176	E2	92.4	135/67.5	414	24.50	
3600	230/460	324TS	U512	324TSTDP4010		√	\$3,176	E2	92.4	117/58.5	414	24.50	68
	1800	200/400	326T	U515	326TTDP4344		\$2,922	E2	93.0	141/70.5	515	27.50	
1800	230/460	326T	U514	326TTDP4345			\$2,922	E2	93.0	123/61.5	345	27.50	68
	3600	200/400	326TS	Y637	326TSTDP8219	√	\$3,242	E2	90.2	167/83.5	465	26.00	d
3600	200/400	326TS	U517	326TSTDP4022		√	\$3,611	E2	93.0	155/77.5	378	26.00	
	230/460	326TS	U516	326TSTDP4024		√	\$3,611	E2	93.0	135/67.5	378	26.00	68
1800	200/400	326TS	U521	326TSTDR14034			\$3,285	E2	93.6	167/83.5	418	29.50	
1800	200/400	364TS	U519	364TSTDS4337			\$3,682	E2	93.6	166/83.0	699	26.50	
1800	200/400	364T	U538	364TTDS14329			\$3,682	E2	93.6	166/83.0	716	28.62	
1800	230/460	364T	U520	364TTDS4328			\$3,682	E2	93.6	144/72.0	716	28.62	68
1800	230/460	364TS	U518	364TSTDS4332		√	\$3,682	E2	93.6	144/72.0	686	26.50	68
75	3600	200/400	364TS	U523	364TSTDS4024	√	\$4,949	E2	93.0	210/105	713	26.50	

Catalog numbers (Cat No.) highlighted in bold blue have efficiency levels that meet EISA requirements

Blue shaded areas are Cast Iron Frames

Continued on next page.

Fire Pump, Three Phase

Dripproof, Rigid Base

HP	RPM	VOLTS	FRAME	CAT. NO.	MODEL NO.	STOCK	LIST PRICE	MULT. SYMB.	NOM. EFF.	F.L. AMPS	WEIGHT	"C" DIM.	FOOT NOTES
75	3600	230/460	364TS	U522	364TSTDS4025	√	\$4,949	E2	93.0	183/91.5	950	26.50	68
	1800	200/400	365TS	U525	365TSTDS4347		\$4,485	E2	94.1	204/102	766	27.50	
	1800	230/460	365TS	U524	365TSTDS4332	√	\$4,485	E2	94.1	177/88.5	772	27.50	68
100	3600	200/400	365TS	U527	365TSTDS4303	√	\$6,501	E2	93.0	276/138	748	27.50	68
	3600	200/400	365TS	Y647	365TSTDS7904	√	\$5,943	E2	91.7	274/137	690	27.50	d
	3600	230/460	365TS	U526	365TSTDS4025	√	\$6,501	E2	93.0	240/120	721	27.50	68
	1800	200/400	404TS	U529	404TSTDS4333	√	\$5,807	E2	94.1	271/136	850	29.50	
	1800	230/460	404TS	U528	404TSTDS4332	√	\$5,720	E2	94.1	236/118	1002	29.50	68
125	3600	200/400	404TS	Y651	404TSTDS7623	√	\$7,310	E2	92.4	322/161	910	29.50	d
	3600	200/400	404TS	U531	404TSTDS14008	√	\$8,087	E2	93.6	327/163	949	29.50	
	3600	230/460	404TS	U530	404TSTDS4017	√	\$8,087	E2	93.6	284/142	933	29.50	68
	1800	200/400	405TS	U533	405TSTDS4333		\$6,849	E2	94.5	336/168	1070	31.00	
	1800	230/460	405TS	U532	405TSTDS4332	√	\$6,849	E2	94.5	292/146	925	31.00	68
150	3600	460	405TS	U534	405TSTDS4006	√	\$9,838	E2	93.6	169	1004	31.00	68
	1800	460	444TS	U535	444TSTDS4332	√	\$9,891	E2	95.0	173	1286	34.00	68
200	3600	460	444TS	U536	444TSTDS4010	√	\$15,304	E2	94.5	225	1313	34.00	68
	1800	460	445TS	U537	445TSTDS4332	√	\$12,496	E2	95.0	233	1414	36.00	68
250	3600	460	445TS	U539	445TSTDS14007	√	\$15,937	E2	94.5	279	1608	36.00	68
	1800	460	445TS	U540	445TSTDS14051	√	\$13,790	E2	95.4	287	1642	36.00	68
300	3600	460	447TS	H178	447TSTDN7001	√	\$16,918	E6	95.0	332	1940	39.50	F,25,68
	1800	460	447TS	H812	447TSTDN7026	√	\$15,976	E6	95.4	345	1994	39.50	F,25,68
350	3600	460	447TS	H193	447TSTDN7003	√	\$19,379	E6	95.0	385	2013	39.50	F,25,68
	1800	460	447TS	H813	447TSTDN7027	√	\$17,363	E6	95.4	400	2064	39.50	F,25,68
400	3600	460	447TS	H817	447TSTDN7005	√	\$22,049	E6	95.4	440	2150	39.50	F,25,68
	1800	460	447TS	H814	447TSTDN7028	√	\$20,152	E6	95.4	450	2220	39.50	F,25
450	3600	460	449TS	H818	449TSTDN7001	√	\$23,550	E6	95.8	495	2544	44.50	F,TS,25,68
	1800	460	449TS	H815A	449TSTDN14033		\$23,169	E6	95.8	505	2937	44.50	F,TS,25
500	3600	460	449TS	H819A	449TSTDN14005	√	\$28,591	E6	95.8	545	2892	44.50	F,TS,25
	1800	460	449TS	H816	449TSTDN7027		\$23,599	E6	95.8	560	2695	44.50	F,TS,25

Catalog numbers (Cat No.) highlighted in bold blue have efficiency levels that meet EISA requirements

Blue shaded areas are Cast Iron Frames

Continued on next page.



Vertical Solid Shaft P-Base

Three Phase, Dripproof

Applications:

For use on: Vertical end suction, short couple, centrifugal, non-clog, mix flow, turbine, and propeller pumps. HP type shafts, per NEMA MG-1 18.625. HPH and TCV type shafts, single phase, and other modifications such as adding screens are also available through special order. Contact Marathon Electric for more information.

Features:

- Normal thrust
- Ball bearings
- Class B insulation
- 1.15 Service Factor
- Suitable for 230 volt part winding start through 100 HP (dual voltage motors)
- Heavy duty lifting lugs
- Drip cover/canopy cap included
- UL Recognized and CSA Certified

HP	RPM	VOLTS	FRAME	CAT. NO.	MODEL NO.	STOCK	LIST PRICE	MULT. SYMB.	NOM. EFF.	F.L. AMPS	WEIGHT	DOWN THRUST	BASE DIA	"C" DIM.	FOOT NOTES
3	1800	230/460	182HP	M801A	182TTDR14027		\$870	S5	86.5	9.3/4.7	83	390	9.88	17.18	
	1200	230/460	213HP	M802A	213TTDW14084		\$1,357	S5	86.5	8.4/4.2	104	560	9.88	20.30	
5	3600	230/460	182HP	M803A	182TTDR14026		\$1,393	S5	87.5	13.0/6.5	87	310	9.88	17.68	
	1800	230/460	184HP	M804A	184TTDR4173		\$1,338	S5	87.5	13.2/6.6	168	490	9.88	17.18	
7 1/2	1200	230/460	215HP	M805A	215TTDW14087		\$1,916	S5	87.5	14.2/7.1	138	650	9.88	21.55	
	1800	230/460	213HP	M807A	213TTDW14054		\$1,672	S5	88.5	19.2/9.6	335	560	9.88	20.30	
10	1200	230/460	254HP	M808A	254TTDX14088		\$2,281	S5	88.5	21.4/10.7	210	720	9.88	24.30	
	1800	230/460	215HP	M810A	215TTDW4071		\$1,878	S5	89.5	25.0/12.5	120	560	9.88	20.30	
15	1200	230/460	256HP	M811A	256TTDX4094		\$2,576	S5	90.2	28.0/14.0	238	720	9.88	24.30	
	3600	230/460	215HP	M813A	215TTDW14018		\$2,184	S5	89.5	34.0/17.0	80	520	9.88	21.55	
20	1800	230/460	254HP	M814A	254TTDX14064		\$2,245	S5	91.0	38.5/19.2	227	640	9.88	24.30	
	1200	230/460	284HP	M815A	284TTDR14082		\$3,002	S5	90.2	39.0/19.5	486	800	12.55	27.06	
25	1800	230/460	256HP	M818A	256TTDX14039		\$2,561	S5	91.0	50.0/25.0	241	640	9.88	24.30	
	1200	230/460	286HP	M819A	286TTDR14081		\$3,652	S5	91.0	53.0/26.5	562	800	12.55	29.56	
30	900	230/460	324HP	M820A	324TTDR14104		\$4,109	S5	90.2	60.0/30.0	465	1100	16.38	30.56	
	3600	230/460	256HP	M821A	256TTDX4310		\$2,525	S5	91.0	58.0/29.0	225	520	9.88	24.30	
35	1800	230/460	284HP	M822A	286TTDR14046		\$2,854	S5	91.7	66.0/33.0	289	700	12.55	27.06	
	1200	230/460	324HP	M823A	324TTDR14080		\$3,968	S5	91.7	66.0/33.0	460	1000	16.38	30.06	
40	900	230/460	326HP	M824A	326TTDR14103		\$4,733	S5	90.2	73.0/36.5	611	1100	16.38	30.56	
	3600	230/460	284HP	M825A	284TTDR14011		\$2,764	S5	91.0	72.0/36.0	292	550	12.55	27.06	
45	1800	230/460	286HP	M826A	286TTDR14042		\$3,210	S5	92.4	72.0/36.0	520	700	12.55	29.56	
	900	230/460	364HP	M828A	364TTDS14104		\$5,311	S5	91.0	82.0/41.0	700	1100	16.5	29.00	
50	3600	230/460	286HP	M829	286TTDR17009		\$3,613	S5	91.7	94.0/47.0	347	550	12.55	28.56	
	1800	230/460	324HP	M830A	324TTDR14049		\$3,551	S5	93.0	97.0/48.5	480	800	16.38	30.06	
55	1200	230/460	364HP	M831A	364TTDS14081		\$5,535	S5	93.0	105/52.5	772	1000	16.5	29.00	
	900	230/460	365HP	M832A	365TTDS14101		\$6,402	S5	91.0	106/53.0	770	1100	16.5	29.00	
60	3600	230/460	324HP	M833A	324TTDR14010		\$4,167	S5	92.4	117/58.5	510	600	16.38	29.56	
	1800	230/460	326HP	M834A	326TTDR14034		\$4,215	S5	93.0	123/61.5	386	800	16.38	30.56	
65	1200	230/460	365HP	M835A	365TTDS14082		\$6,530	S5	93.0	130/65.0	725	1000	16.5	29.00	
	900	460	404HP	M836A	404TTDS14102		\$7,297	S5	91.7	70.0	790	1400	16.5	31.75	

Catalog numbers (Cat No.) highlighted in bold blue have efficiency levels that meet EISA requirements

Blue shaded areas are Cast Iron Frames

Continued on next page.

Vertical Solid Shaft P-Base

Three Phase, Dripproof

HP	RPM	VOLTS	FRAME	CAT. NO.	MODEL NO.	STOCK	LIST PRICE	MULT. SYMB.	NOM. EFF.	F.L. AMPS	WEIGHT	DOWN THRUST	BASE DIA	"C" DIM.	FOOT NOTES
60	3600	230/460	326HP	M837A	326TTDR14010		\$4,661	S5	93.0	135/67.5	589	600	16.38	30.56	
	1800	230/460	364HP	M838A	364TTDR14032		\$4,868	S5	93.6	145/72.5	587	800	16.38	34.19	
75	1200	230/460	404HP	M839A	404TTDS14081		\$7,453	S5	93.6	144/72.0	1049	1200	16.50	31.75	
	900	230/460	405HP	M840	405TTDS7124		\$8,415	S5	92.4	166/83.0	1077	1400	16.50	31.75	
75	3600	230/460	364HP	M841A	364TTDS14011		\$5,832	S5	93.0	183/91.5	733	600	16.50	29.00	
	1800	230/460	365HP	M842A	365TTDS4328		\$5,926	S5	94.1	179/89.5	810	800	16.50	29.00	
	1200	230/460	405HP	M843A	405TTDS4376		\$8,767	S5	93.6	176/88.0	1097	1200	16.50	31.75	
	900	460	444HP	M844A	444TTDS14101		\$9,651	S5	93.6	95.0	1210	1600	16.38	36.02	
100	3600	230/460	365HP	M845A	365TTDS14009		\$7,860	S5	93.0	240/120	762	600	16.50	29.00	
	1800	230/460	404HP	M846A	404TTDS4359		\$7,487	S5	94.1	236/118	1100	900	16.50	31.75	
	1200	230/460	444HP	M847A	444TTDS14086		\$10,881	S5	94.1	236/118	1317	1400	16.38	36.02	
	900	460	445HP	M848	445TTDS7121		\$12,948	S5	93.6	128	1504	1600	16.38	36.02	
125	3600	460	404HP	M849A	404TTDS14005		\$9,876	S5	93.6	142	1009	600	16.50	31.75	
	1800	460	405HP	M850A	405TTDS14067		\$9,043	S5	94.5	147	1142	900	16.50	31.75	
	1200	460	445HP	M851A	445TTDS14087		\$12,920	S5	94.1	147	1385	1400	16.38	36.02	
	900	460	505P	M852	505UTDS805		\$17,208	S5	93.6	168	1976	1600	20.00	38.75	
150	3600	460	405HP	M853A	405TTDS14003		\$11,998	S5	93.6	169	1071	600	16.50	31.75	
	1800	460	444HP	M854A	444TTDS14057		\$10,849	S5	95.0	176	1240	1000	16.38	36.02	
	1200	460	445HP	M855A	445TTDS17084		\$15,604	S5	94.5	178	1498	1400	16.38	36.02	
	900	460	505P	M856	505UTDS819		\$21,330	S5	93.6	191	2148	1600	20.00	38.75	
200	3600	460	444HP	M857A	444TTDS14003		\$16,398	S5	94.5	225	1357	600	16.38	36.02	
	1800	460	445HP	M858A	445TTDS14063		\$14,744	S5	95.0	233	1395	1000	16.38	36.02	
	1200	460	505P	M859A	505UTDS14077		\$22,807	S5	94.5	240	2145	1400	20.00	38.75	
	900	460	505P	M860	505UTDS5820		\$24,004	S5	93.6	268	1250	1600	20.00	38.75	
250	3600	460	445HP	M861A	445TTDS14003		\$17,555	S5	94.5	279	1520	600	16.38	36.02	
	1800	460	445HP	M862A	445TTDS14062		\$15,584	S5	95.4	286	1550	1000	16.38	36.02	
	1200	460	505P	M863A	505UTDS3999		\$24,323	S5	95.4	295	2318	1400	20.00	38.75	
	900	460	508P	M864	---		\$29,108	S5	94.5	308		1600	20.00	45.75	
300	1800	460	505P	M866A	---		\$18,771	S5	95.4	340		1000	20.00	38.75	
	1200	460	508P	M867A	---		\$28,052	S5	95.4	342		1400	20.00	45.75	
	900	460	508P	M868	---		\$34,426	S5	93.6	375		1600	20.00	45.75	NE
350	3600	460	505P	M869A	---		\$26,619	S5	95.0	378		600	20.00	38.75	
	1800	460	505P	M870	---		\$21,824	S5	95.4	402		1000	20.00	38.75	
	1200	460	508P	M871A	---		\$32,512	S5	95.4	400		1400	20.00	45.75	
400	1800	460	505P	M873	---		\$26,188	S5	95.4	455		1000	20.00	38.75	
	1200	460	508P	M874	---		\$37,339	S5	95.0	460		1400	20.00	45.75	NE

Catalog numbers (Cat No.) highlighted in bold blue have efficiency levels that meet EISA requirements

Blue shaded areas are Cast Iron Frames

Continued on next page.

VERTICAL P-BASE

Vertical Solid Shaft P-Base

Three Phase, Totally Enclosed

Applications:

For use on: Vertical end suction, short couple, centrifugal, non-clog, mix flow, turbine, and propeller pumps. Totally Enclosed, Fan Cooled construction restricts the free exchange of ambient air inside the motor. Suitable for demanding applications in the process industries. HP type shafts, per NEMA MG-1, 18.625. HPH type shafts, severe duty features, explosion proof, and other modifications such as adding screens are also available through special order. Contact Marathon Electric for more information.

Features:

- Normal thrust
- Class F insulation
- 1.15 Service Factor
- Suitable for 230 volt part winding start through 100 HP (dual voltage motors)
- Heavy duty lifting lugs
- Drip cover/canopy cap included
- UL Recognized and CSA Certified

HP	RPM	VOLTS	FRAME	CAT. NO.	MODEL NO.	STOCK	LIST PRICE	MULT. SYMB.	NOM. EFF.	F.L. AMPS	WEIGHT	DOWN THRUST	BASE DIA	"C" DIM.	FOOT NOTES
3	3600	230/460	182HP	M875A	182TTFW14005		\$1,291	S5	85.5	7.4/3.7	89	260	9.88	18.05	
	1800	230/460	182HP	M876A	182TTFW14026		\$1,132	S5	87.5	8.4/4.2	124	390	9.88	18.05	
	1200	230/460	213HP	M877A	213TTFW14080		\$1,766	S5	87.5	9.2/4.6	134	560	9.88	22.66	
5	1800	230/460	184HP	M879A	184TTFW14026		\$1,586	S5	87.5	13.0/6.5	79	490	9.88	20.05	
	1200	230/460	215HP	M880A	215TTFW14083		\$2,488	S5	87.5	14.0/7.0	139	650	9.88	23.91	
7 1/2	3600	230/460	213HP	M881A	213TTFW14010		\$2,245	S5	88.5	18.4/9.2	157	380	9.88	22.66	
	1200	230/460	254HP	M883A	254TTFNA14084		\$2,968	S5	89.5	19.6/9.8	401	720	9.88	28.26	
10	3600	230/460	215HP	M884A	215TTFW14021		\$2,445	S5	89.5	24.0/12.0	160	450	9.88	22.66	
	1800	230/460	215HP	M885A	215TTFW14040		\$2,445	S5	89.5	26.0/13.0	158	560	9.88	23.91	
	1200	230/460	256HP	M886A	256TTFNA14084		\$3,351	S5	89.5	26.0/13.0	420	720	9.88	28.26	
15	3600	230/460	254HP	M888	254TTFNA7012		\$2,818	S5	90.2	35.0/17.5	272	520	9.88	28.26	
	1200	230/460	284HP	M890A	284TTFPA14049		\$3,907	S5	90.2	36.0/18.0	400	800	9.88	28.88	
20	3600	230/460	256HP	M892A	256TTFNA14016		\$3,083	S5	90.2	47.0/23.5	413	520	9.88	28.26	
	1800	230/460	256HP	M893	256TTFNA7028		\$3,329	S5	91.0	50.0/25.0	587	640	9.88	28.26	
	1200	230/460	286HP	M894A	286TTFNA14085		\$4,748	S5	90.2	54.0/27.0	438	800	9.88	30.84	
25	3600	230/460	284HP	M896	284TTFNA7508		\$3,257	S5	91.0	57.0/28.5	520	550	9.88	30.84	
	1800	230/460	284HP	M897A	284TTFPA14048		\$3,710	S5	92.4	62.0/31.0	466	700	9.88	28.88	
	1200	230/460	324HP	M898A	324TTFPA14089		\$5,556	S5	91.7	67.0/33.5	610	1000	16.38	33.09	
30	900	230/460	326HP	M899A	326TTFFS14103		\$6,627	S5	89.5	73.0/36.5	835	1100	16.38	35.62	
	3600	230/460	286HP	M900A	286TTFPA14011		\$3,594	S5	91.0	72.0/36.0	550	550	9.88	27.38	
	1800	230/460	286HP	M901A	286TTFPA14063		\$4,174	S5	92.4	74.0/37.0	653	700	9.88	27.38	
40	1200	230/460	326HP	M902A	326TTFFS14087		\$6,344	S5	91.7	76.0/38.0	788	1000	16.38	35.62	
	3600	230/460	324HP	M904A	324TTFFS14003		\$4,744	S5	91.7	92.0/46.0	738	600	16.38	35.62	
	1800	230/460	324HP	M905A	324TTFPA14065		\$4,973	S5	93.0	100/50.0	761	800	16.38	33.09	
50	1200	230/460	364HP	M906A	364TTFFS14087		\$8,305	S5	93.0	102/51.0	934	1000	16.38	37.44	
	900	230/460	365HP	M907	365TTFFS17102		\$9,604	S5	91.0	111/55.5	1112	1100	16.38	37.44	
	3600	230/460	326HP	M909A	326TTFPA14049		\$5,897	S5	93.0	122/61.0	649	800	16.38	34.59	
1200	230/460	365HP	M910A	365TTFFS14084		\$9,792	S5	93.0	130/65.0	998	1000	16.38	37.44		

PUMP MOTORS (FLUID HANDLING)

Catalog numbers (Cat No.) highlighted in bold blue have efficiency levels that meet EISA requirements

Blue shaded areas are Cast Iron Frames

Continued on next page.

Vertical Solid Shaft P-Base

Three Phase, Totally Enclosed

HP	RPM	VOLTS	FRAME	CAT. NO.	MODEL NO.	STOCK	LIST PRICE	MULT. SYMB.	NOM. EFF.	F.L. AMPS	WEIGHT	DOWN THRUST	BASE DIA	"C" DIM.	FOOT NOTES
60	3600	230/460	364HP	M912A	364TTFS14003		\$6,993	S5	93.0	141/70.5	978	600	16.38	37.44	
	1800	230/460	364HP	M913A	364TTFS14058		\$7,297	S5	93.6	142/71.0	998	800	16.38	37.44	
	1200	230/460	404HP	M914A	404TTFS14088		\$11,929	S5	93.6	149/74.5	1232	1400	16.38	40.69	
75	3600	230/460	365HP	M916A	365TTFS7923		\$8,734	S5	93.0	174/87.0	1059	600	16.38	37.44	
	1800	230/460	365HP	M917A	365TTFS14060		\$8,890	S5	94.1	178/89.0	1130	800	16.38	37.44	
	1200	230/460	405HP	M918A	405TTFS14087		\$14,029	S5	93.6	185/92.5	1340	1400	16.38	40.69	
100	900	460	444HP	M919	444TTFS7403		\$16,887	S5	93.0	97.0	1889	1600	16.38	45.81	
	3600	230/460	405HP	M920	405TTFS7612		\$12,579	S5	93.6	220/110	1341	600	16.38	40.69	
	1800	230/460	405HP	M921A	405TTFS14063		\$11,977	S5	94.5	228/114	1430	900	16.38	40.69	
125	1200	230/460	444HP	M922A	444TTFN14080		\$18,701	S5	94.1	248/124	1865	1400	16.38	43.50	
	3600	460	444HP	M924	444TTFS7321		\$16,974	S5	94.5	137	1846	600	16.38	45.81	
	1800	460	444HP	M925A	444TTFN14044		\$15,546	S5	94.5	145	1756	1000	16.38	43.50	
150	1200	460	445HP	M926A	445TTFN14086		\$22,607	S5	94.1	152	2248	1400	16.38	43.50	
	3600	460	445HP	M928A	445TTFN14003		\$20,627	S5	94.5	167	1780	600	16.38	43.50	
	1800	460	445HP	M929A	445TTFN14326		\$18,988	S5	95.0	172	2292	1000	16.38	43.50	
200	900	460	449HP	M931	449TTFS7109		\$39,890	S5	93.6	206	3290	1600	16.38	54.25	
	1800	460	445HP	M933A	445TTFN14330		\$26,535	S5	95.0	225	2290	1000	16.38	43.50	

Catalog numbers (Cat No.) highlighted in bold blue have efficiency levels that meet EISA requirements

Blue shaded areas are Cast Iron Frames

Aeration Fan, Farm / Agricultural Duty, Single Phase TEAO, Rigid Base

Applications:

Direct drive vane axial fans. These totally enclosed/air over motors must be mounted within the airstream for proper cooling. These aeration fan motors are often used in agricultural applications.

Features:

- Capacitor start design for high starting torque
- 1.0 Service Factor except as noted
- UL Recognized and CSA Certified
- 18" Leads for ease of connection
- 56Z & 143-5TZ have keyway and 1/4" x 20" UNC tapped hole



HP	RPM	VOLTS	FRAME	OVER LOAD	CAT. NO.	MODEL NO.	STOCK	LIST PRICE	MULT. SYMB.	F.L. AMPS	WEIGHT	"C" DIM.	FOOT NOTES
3/4	3600	115/230	56Z	AUTO	C1467	5KC37NN3544T	√	\$260	F1	9.8/4.9	20	11.26	10
1	3600	115/230	56Z	AUTO	C1468	5KC49NN2081T	√	\$288	F1	13.0/6.5	26	11.74	10
1 1/2	3600	115/230	143TZ	AUTO	C1273	5KC49SN8060T	√	\$581	S1	16.4/8.2	35	12.28	
2	3600	115/230	145TZ	AUTO	C1274	5KCR49TN8058T	√	\$711	S1	17.8/8.9	37	12.28	1,18
3	3600	230	145T	AUTO	C1275	5KCR49ZN8061T	√	\$969	S1	13.2	49	13.69	1,18

Attic Fan, Split Phase Dripproof, Air Over, Resilient Base

Features:

- Variable torque on two speed motors
- 48Y Frame has 48/56 Frame mounting holes
- 56YZ frame with 3" shaft height, 1/2" diameter shaft, and 5/8" adapter with keyway included
- UL Recognized and CSA Certified



HP	RPM	VOLTS	FRAME	OVER LOAD	CAT. NO.	MODEL NO.	STOCK	LIST PRICE	MULT. SYMB.	F.L. AMPS	WEIGHT	"C" DIM.	FOOT NOTES
1/3	1800/1200	115	48Y	AUTO	B402	48S17D7209	√	\$209	F1	5.3/2.9	21	10.31	
	1800	115	48Y	AUTO	B400	48S17D997	√	\$138	F1	6.6	14	9.34	
1/2	1800	115	56YZ	AUTO	B401	56S17D2062	√	\$172	F1	7.8	18	10.47	53

Centrifugal Fan, Single Phase Dripproof, Rigid Base

Applications:

Direct drive centrifugal fans installed in relatively clean and dry applications.

Features:

- Capacitor start/capacitor run design for high starting torque and low amps
- Ball bearings, mechanically locked on shaft end
- Heavy gauge steel frame and base
- Shafts are 1" longer than NEMA standard for extra clearance
- Rodent screens
- Thermostats for thermal overload protection
- 1.15 Service Factor (unless otherwise noted)
- UL Recognized and CSA Certified

HP	RPM	VOLTS	FRAME	CAT. NO.	MODEL NO.	STOCK	LIST PRICE	MULT. SYMB.	F.L. AMPS	WEIGHT	"C" DIM.	FOOT NOTES
5	1800	208-230	184TZ	Z1124	184TBDW7369		\$1,388	S1	23.0-21.0	82	16.72	13
7 1/2	1800	208-230	215TZ	Z125	215TBDR7361		\$1,837	S1	35.2	135	19.19	
10	1800	230	215TZ	Z126	215TBDW7362		\$1,939	S1	44.0	158	18.70	
15	1800	230	256TZ	Z127	256TBDX7028		\$2,404	S1	61.0	187	24.06	17

Condenser Fan/Heat Pump, PSC, Open Air Over Thru-Bolt, Shaft Up or Horizontal

Applications:

Direct drive condenser fans mounted vertically, shaft up. Models with open brackets should be mounted where they are shielded from rain. These motors need to be mounted within the airflow of the fan for proper cooling.

Features:

- Frame and shaft end bracket enclosed, except X011, X012, and X208 have open frames and X426 has open frame and brackets
- Single and multi-speed models as noted
- Ball bearings
- Weather resistant reversing plug
- 30" long leads
- Shaft with flat, unless otherwise noted
- 60°C ambient (as noted)
- Shaft slinger
- 1-5/8" Extended thru-bolts on shaft end, except where noted
- Automatic reset thermal protector
- Lug mount kits and other accessories available, see Accessories section
- UL Recognized and CSA Certified
- Capacitor not included, see Accessories section



X208



X081



X426



X011

HP	RPM	VOLTS	FRAME	CAT. NO.	MODEL NO.	STOCK	LIST PRICE	MULT. SYMB.	F.L. AMPS	WEIGHT	FRAME LENGTH	SHAFT DIM.	FOOT NOTES
1/4	1625/1	208-230	48Y	X012	48A17O2006	✓	\$147	F1	1.8-1.8	12	4 1/2	1/2 x 6	30,34,44
	1625/1	460	48Y	X420	48A17O169	✓	\$197	F1	1.0	12	4	1/2 x 6	34
	1075/2	208-230	48Y	X081	48A11O2031	✓	\$164	F1	1.9-1.9	12	4 1/4	1/2 x 6	
	1075/2	208-230	48Y	X080	48A11O2030	✓	\$146	F1	1.9-1.9	12	4 1/4	1/2 X 6	d
	1075/1	208-230	48Y	X213	48A11O1524	✓	\$140	F1	1.4-1.2	12	4 1/4	1/2 X 6	21
	1075/1	208-230	48Y	X087	48A11O2029	✓	\$133	F1	2.0-2.0	12	4 1/4	1/2 x 6	
	1075/1	460	48Y	X423	48A11O2055	✓	\$152	F1	1.0	13	4 1/4	1/2 x 6	36
	825/1	208-230	48Y	X097	48A8O182	✓	\$197	F1	1.8-1.8	13	4 1/2	1/2 x 6	
1/3	1625/3	208-230	48Y	X011	48A17O2005	✓	\$158	F1	2.3-2.3	14	4 3/4	1/2 x 6	30,34,44
	1075/2	208-230	48Y	X083	48A11O2034	✓	\$174	F1	3.0-3.0	18	4 3/4	1/2 x 6	
	1075/2	208-230	48Y	X082	48A11O2033	✓	\$159	F1	3.0-3.0	14	4 3/4	1/2 x 6	d

Continued on next page.

Condenser Fan/Heat Pump, PSC, Open Air Over

Thru-Bolt, Shaft Up or Horizontal

HP	RPM	VOLTS	FRAME	CAT. NO.	MODEL NO.	STOCK	LIST PRICE	MULT. SYMB.	F.L. AMPS	WEIGHT	FRAME LENGTH	SHAFT DIM.	FOOT NOTES	
1/3	1075/1	208-230	48Y	X214	48A11O1525	✓	\$139	F1	2.3-2.6	139	4 1/2	1/2 x 6	45	
	1075/1	208-230	48Y	X088	48A11O2032	✓	\$143	F1	3.0-3.0	143	4 3/4	1/2 x 6		
	1075/1	460	48Y	X424	48A11O2054	✓	\$172	F1	1.4	172	4 3/4	1/2 x 6	36	
	825/1	208-230	48Y	X086	48A8O2001	✓	\$221	F1	2.4-2.4	221	5 1/4	1/2 x 6		
1/2	1625/1	460	48Y	X422	48A17O172	✓	\$249	F1	1.7	249	5	1/2 x 6	36	
	1625/1	575	48Y	X454	48A17O250	✓	\$249	F1	1.35	249	5	1/2 x 6	36	
	1075/1	208-230	48Y	X096	48A11O840	✓	\$191	F1	4.2-4.2	191	5 1/2	1/2 x 6		
	1075/1	208-230	48Y	X221	48A11O1526	✓	\$169	F1	2.7-2.6	169	5	1/2 x 6	45	
	1075/1	460	48Y	X400	48A11O2017	✓	\$194	F1	1.8	194	5	1/2 x 6	35	
	1075/1	575	48Y	X453	48A11O1771	✓	\$194	F1	1.15	194	5	1/2 x 6	35	
	825/1	208-230	48Y	X098	48A8O181	✓	\$266	F1	3.3-3.3	266	5 1/2	1/2 x 6		
	825/1	208-230	56Z	X208	56A8O5	✓	\$407	F1	3.4-3.4	407	8 5/8	5/8 x 6 w/key/flat	30	
	3/4	1075/2	208-230	48Y	X085	48A11O678	✓	\$221	F1	5.1-5.1	221	5 1/2	1/2 x 6	
		1075/1	208-230	48Y	X298	48A11O2059	✓	\$185	F1	4.0-4.2	185	5 1/4	1/2 x 6	
1075/1		208-230	48Y	X090	48A11O2007	✓	\$209	F1	4.6-4.6	209	5 1/2	1/2 x 6		
1075/1		460	48Y	X099	48A11O2016	✓	\$223	F1	2.5	223	5 1/2	1/2 x 6	34	
1075/1		460	48YZ	X426	48A11O1375	✓	\$270	F1	2.2	270	5 1/2	5/8 x 4.5 w/key	69	
1075/1		575	48Y	X455	48A11O1770	✓	\$223	F1	1.7	223	5 1/2	1/2 x 6	35	
1	1075/1	200-230/460	56Z	P190	5KCP49ZN9617T	✓	\$477	F1	6.7-6.8/3.4	477	9.0	5/8 x 4		

Condenser Fan/Heat Pump, PSC, Open Air Over

Thru-Bolt Mount, Shaft Down

Applications:

Direct drive condenser fans mounted vertically, shaft down. These motors need to be mounted within the airflow of the fan for proper cooling.

Features:

- Frame and opposite shaft end bracket are enclosed for vertical shaft down mounting
- Weather resistant reversing plug
- 30" Long leads
- Shaft slinger
- 1-1/4" Extended thru-bolts on shaft end, except where noted
- Automatic reset thermal protector
- Ball Bearings
- UL Recognized and CSA Certified
- Capacitor not included, see Accessories section



HP	RPM	VOLTS	FRAME	CAT. NO.	MODEL NO.	STOCK	LIST PRICE	MULT. SYMB.	F.L. AMPS	WEIGHT	FRAME LENGTH	SHAFT DIM.	FOOT NOTES
1/8	825	208-230	48Y	X278	48A8O206	✓	\$181	F1	0.9-0.9	11	4 1/4	1/2 X 4 3/4	37,44
1/6	1075	208-230	48Y	X440	48A11O2065	✓	\$119	F1	1.0-0.9	10	4	1/2 X 6	
1/5	1075	208-230	48Y	X216	48A11O1097	✓	\$133	F1	1.8-1.6	10	3 3/4	1/2 X 6	37,44,60
1/4	1075	208-230	48Y	X441	48A11O2062	✓	\$146	F1	1.35-1.35	12	4 1/4	1/2 X 6	
1/3	1075	208-230	48Y	X442	48A11O2064	✓	\$156	F1	2.0-1.95	14	4 3/4	1/2 X 6	
	1075	208-230	48Y	X297	48A11T509	✓	\$141	F1	1.8-1.8	12	4 1/4	1/2 X 3 3/4	N,29,41,60
1/2	1075	208-230	48Y	X443	48A11O2063	✓	\$173	F1	3.9-3.9	18	5 1/4	1/2 X 6	
3/4	1075	208-230	48Y	X444	48A11O1596	✓	\$230	F1	4.3-4.7	18	5 1/2	1/2 X 6	

Condenser Fan/Heat Pump, PSC, Air Over 48 Frame, Thru-Bolt, All-Angle



Applications:

Direct drive condenser fans for all angle mounting. These motors need to be mounted within the airflow of the fan for proper cooling.

Features:

- Frame and end brackets enclosed
- Single and multi-speed models, as noted
- Ball bearings (except as noted)
- Weather resistant reversing plug
- 30" long leads
- Shaft slinger
- 1-1/2" Thru-bolts on shaft end, 1" thru-bolts on lead end (except as noted)
- Automatic reset thermal protector
- Weep holes with removable plugs on end brackets. Remove bottom plug after installation.
- Lug mount kits and other accessories available (see Accessories section)
- 60°C ambient, as noted
- UL Recognized and CSA Certified
- Capacitor not included, see Accessories section

HP	RPM	VOLTS	FRAME	CAT. NO.	MODEL NO.	STOCK	LIST PRICE	MULT. SYMB.	F.L. AMPS	WEIGHT	FRAME LENGTH	SHAFT DIM.	FOOT NOTES
1/6	1075/2	208-230	48Y	X429	48A11T2020	√	\$160	F1	1.3-1.3	11	4	1/2 x 6	36
	1075/1	208-230	48Y	X411	48A11T2008	√	\$152	F1	1.3-1.3	10	3 3/4	1/2 x 6	
	825/1	208-230	48Y	X465	48A8T11002	√	\$160	F1	1.1-1.1	12	4 1/4	1/2 x 6	45
1/4	1625/1	208-230	48Y	X467	48A17T87	√	\$143	F1	2.0-2.0	12	4 1/2	1/2 x 6	21,36
	1625/2	208-230	48Y	X463	48A17T356	√	\$164	F1	1.4-1.4	13	4 1/2	1/2 x 6	45,94
	1075/2	208-230	48Y	X430	48A11T463	√	\$174	F1	1.8-1.8	16	4 1/2	1/2 x 6	36
	1075/1	208-230	48Y	X412	48A11T569	√	\$169	F1	1.4-1.4	16	4 1/4	1/2 x 6	45
	1075/1	460	48Y	X456	48A11T578	√	\$174	F1	0.75	15	4 1/2	1/2 x 6	45
	840/1	208-230	48Y	X450	48A8T71	√	\$164	F1	1.9-1.9	17	5 1/4	1/2 x 6	45
1/3	1625/1	208-230	48Y	X466	48A17T86	√	\$157	F1	2.0-2.0	15	5	1/2 x 6	21,36
	1075/2	208-230	48Y	X415	48A11T2012	√	\$186	F1	2.6-2.6	16	5	1/2 x 6	36
	1075/1	208-230	48Y	X413	48A11T529	√	\$183	F1	1.9-1.9	14	4 3/4	1/2 x 6	45
	1075/1	460	48Y	X457	48A11T579	√	\$185	F1	0.9	17	5	1/2 x 6	36,45
	825/1	208-230	48Y	X451	48A8T72	√	\$173	F1	2.3-2.3	19	5 3/4	1/2 x 6	34,45
1/2	1625/1	208-230	48Y	X468	48A17T96	√	\$177	F1	2.9-2.6	16	5 1/4	1/2 x 6	21
	1625/2	208-230	48Y	X464	48A17T359		\$199	F1	3.1-2.9	17	5 1/4	1/2 x 6	45
	1075/2	208-230	48Y	X416	48A11T2013	√	\$204	F1	4.2-4.2	19	5 1/2	1/2 x 6	36
	1075/1	208-230	48Y	X414	48A11T571	√	\$201	F1	2.7-2.7	17	5	1/2 x 6	36,45
	1075/1	460	48Y	X458	48A11T580	√	\$204	F1	1.4	20	5 1/2	1/2 x 6	36,45
	825/1	208-230	48Y	X452	48A8T73	√	\$213	F1	3.1	21	6 1/4	1/2 x 6	45
3/4	1075/1	208-230	48Y	X469	48A11T276	√	\$177	F1	4.2-3.65	21	6	1/2 x 6	21,63
	1075/1	460	48Y	X459	48A11T581	√	\$230	F1	2.1	23	6	1/2 x 6	32,45
1	1075/1	460	48Y	X462	48A11T619	√	\$272	F1	3.4	27	7 1/4	1/2 x 6	32,45

Condenser Fan/Heat Pump, PSC, Open Air Over Rigid Base, Shaft Up or Horizontal

Applications:

Condenser fans, installed outdoors. These motors need to be mounted within the airflow of the fan for proper cooling.

Features:

- Frame and shaft end bracket enclosed
- Heavy gauge steel constructions
- 56Y frame has non-NEMA BA dimension of 1.97"
- Automatic reset thermal protector
- Flat and keyway on shaft
- Ball Bearings
- UL Recognized and CSA Certified
- Capacitor included on X432, see Accessories section to order capacitor for X433



HP	RPM	VOLTS	FRAME	CAT. NO.	MODEL NO.	STOCK	LIST PRICE	MULT. SYMB.	F.L. AMPS	WEIGHT	FRAME LENGTH	SHAFT DIM.	FOOT NOTES
3/4	1075	208-230/460	56YZ	X432	56A11O29	√	\$334	F1	4.6-4.4/2.2	22	11.88	5/8 x 4 1/2	36
1	1075	208-230/460	56YZ	X433	56A11O30	√	\$398	F1	5.8-5.4/2.7	27	12.38	5/8 x 4 1/2	

Condenser Fan/Heat Pump, PSC

56 Frame, Resilient Ring, Thru-Bolt

Applications:

Direct drive condenser fans mounted vertically, shaft up or horizontal. These motors need to be mounted within the airflow of the fan for proper cooling.

Features:

- Enclosed shaft end bracket with vented frame
- Ball bearings
- 30" long leads (except P243)
- Shaft slinger
- 60°C ambient, as noted
- Automatic reset thermal protector
- Flat & keyway on shaft
- UL Recognized and CSA Certified
- Capacitor not included, see Accessories section



Open Air Over, Shaft Up

HP	RPM	VOLTS	FRAME	CAT. NO.	MODEL NO.	STOCK	LIST PRICE	MULT. SYMB.	F.L. AMPS	WEIGHT	FRAME LENGTH	SHAFT DIM.	FOOT NOTES
3/4	1075	208-230/460	56Y	X207	56A11O5311	✓	\$377	F1	3.9-3.6/1.8	31	8 1/4	5/8 x 6	37,45
1	1075	208-230/460	56Y	X206	56A1105310	✓	\$398	F1	5.4-5.2/2.6	34	10 1/16	5/8 x 6	37
1 1/2	1075	208-230/460	56Y	X271	56A11O5305	✓	\$454	F1	7.7-7.6/3.8	43	9 3/4	5/8 x 6	34,45

Dripproof

HP	RPM	VOLTS	FRAME	CAT. NO.	MODEL NO.	STOCK	LIST PRICE	MULT. SYMB.	F.L. AMPS	WEIGHT	FRAME LENGTH	SHAFT DIM.	FOOT NOTES
1/2	825/1	115/208-230	56Y	P245	5KCP49PN9812S	✓	\$513	F1	6.2/3.8-3.1	31	13.66	5/8 X 6	
3/4	1075/1	208-230/460	56Y	P243	5KCP49RN9611S	✓	\$486	F1	4.9-3.8/1.9	33	13.66	5/8 X 6	
	825/1	208-230	56Y	P246	5KCP49UN9811S	✓	\$556	F1	5.8-5.6	32	14.47	5/8 X 6	
1	1075/3	115	56Y	P184	5KCP49UN9612S	✓	\$532	F1	10.8	40	14.87	5/8 x 6	
	1075/3	200-230	56Y	P185	5KCP49UN9614S	✓	\$532	F1	4.8-5.0	34	14.87	5/8 X 6	
	1075/1	208-230/460	56Y	P244	5KCP49UN9613S	✓	\$511	F1	6.3-5.0/2.5	40	14.47	5/8 X 6	
	825/1	208-230/460	56Y	P180	5KCP49WN9813S	✓	\$586	F1	6.3-6.4/3.2	39	11.24	5/8 x 6	

Commercial Condenser Fan/Heat Pump, PSC

Open Air Over, Belly Band, Shaft Up

Applications:

Heavy duty design for commercial direct drive condenser fans mounted vertically, shaft up. These motors need to be mounted within the airflow of the fan for proper cooling.

Features:

- Open frame and end brackets
- Shaft with flat, unless otherwise noted
- Unique Rain Shield fits over shaft to protect motor in vertical shaft up position
- Shaft slinger
- Automatic reset thermal protector
- 60°C ambient (as noted)
- Ball bearings
- UL Recognized and CSA Certified
- Capacitor not included, see Accessories section



HP	RPM	VOLTS	FRAME	CAT. NO.	MODEL NO.	STOCK	LIST PRICE	MULT. SYMB.	F.L. AMPS	WEIGHT	FRAME LENGTH	SHAFT DIM.	FOOT NOTES
0.4	1075	200-230/460	48Y	X445	48A11O1732		\$204	F1	3.0-2.8/1.4	29	5 1/2	1/2 x 4	
0.6	1075	200-230/460	48Y	X446	48A11O1643	✓	\$225	F1	3.0-3.6/1.8	20	6 7/8	1/2 x 4	
0.8	1075	200-230/460	48Y	P193	5KCP395NB4805	✓	\$252	F1	4.0/2.0	21	14.19	1/2 x 2 3/4	d
	1075	200-230/460	48Y	P194	5KCP39SNB481S	✓	\$301	F1	4.0/2.0	21	9 1/3	5/8 x 4 7/8	d
	1075	200-230/460	48Y	X447	48A11O1642	✓	\$301	F1	5.0-4.4/2.2	27	8 3/4	1/2 x 4	45
1	1075	200-230/460	48Y	P195	5KCP39SNB482S	✓	\$325	F1	5.6/2.8	21	10 5/8	5/8 x 5 1/4 w/key/flat	
	1075	200-230/460	56Y	X448	56A11O5314	✓	\$325	F1	6.0-5.2/2.6	33	8 3/4	5/8 x 4 w/key/flat	45
	1075	575	56Y	P196	5KCP39TNB763T	✓	\$325	F1	2.6	22	10 1/4	1/2 x 5 1/4	
1.5	1075	200-230/460	56Y	P197	5KCP39UNB767T	✓	\$373	F1	8.1-7.8/3.9	23	10 1/4	5/8 spcl.	d
	1075	200-230/460	56Y	X449	56A11O5315	✓	\$373	F1	7.0-7.0/3.5	39	9 1/4	5/8 x 4	45
	1075	575	56Y	P198	5KCP39UNB764T	✓	\$373	F1	3.5	23	10 1/4	1/2 x 5 1/4	

Commercial Condenser Fan/Heat Pump, PSC Resilient Base, Shaft Up or Horizontal

Applications:

Condenser fans, installed outdoors. These motors need to be mounted within the airflow of the fan for proper cooling.



Features:

- Frame and shaft end bracket enclosed
- Automatic reset thermal protector
- Ball bearings
- UL Recognized and CSA Certified
- Capacitor included

HP	RPM	VOLTS	FRAME	CAT. NO.	MODEL NO.	STOCK	LIST PRICE	MULT. SYMB.	F.L. AMPS	WEIGHT	FRAME LENGTH	SHAFT DIM.	FOOT NOTES
1/2	1075	208-230/460	48YZ	X431	48A11O1461	✓	\$263	F1	3.0-3.0/1.5	19	11.94	1/2 x 4 1/2	

Commercial Condenser Fan/Heat Pump, Three Phase Open Air Over, Rigid Base, Shaft Up or Horizontal

Applications:

Commercial condenser fans may be installed outdoors. These motors need to be mounted within the airflow of the fan for proper cooling. Used on Trane, Carrier, Climtrol and York units, 5 tons and larger.



Features:

- 70°C ambient (except as noted)
- Enclosed shaft end bracket, vented frame
- Continuous duty, air over
- Automatic reset thermal protector
- Shaft slinger
- Threaded lead exit
 - Nameplated 60/50 hertz 190/380 volts, at next lower HP
- Double sealed ball bearings
- Flat and keyway on shaft
- Patented VCD™ - Voltage Change Device (as noted)
- Ball Bearings
- UL Recognized and CSA Certified



HP	RPM	VOLTS	FRAME	CAT. NO.	MODEL NO.	STOCK	LIST PRICE	MULT. SYMB.	F.L. AMPS	WEIGHT	FRAME LENGTH	SHAFT DIM.	FOOT NOTES
1/3	1140	208-230/460	56Z	X532	56T11O11001	✓	\$355	F1	1.8-1.8/0.9	22	13.37	1/2 x 5	45,50
1/2	1140	208-230/460	56Z	X533	56T11O11002	✓	\$382	F1	2.1-2.0/1.0	20	13.37	5/8 x 5	45,50
	850	208-230/460	56HZ	X529	56T8O5531	✓	\$547	F1	2.9-3.0/1.5	31	14.68	5/8 x 5	VC,5
3/4	1140	208-230/460	56HZ	X512	56T11O15511		\$425	F1	2.7-3.0/1.5	27	14.18	5/8 x 5	VC,5
1	1140	208-230/460	56HZ	K1485	5K49RN6118S	✓	\$435	F1	4.2-4.0/2.0	33	16.02	5/8 X 6	d,46
	1140	208-230/460	56HZ	X513	56T11O5305	✓	\$461	F1	4.1-4.2/2.1	29	14.68	5/8 x 5	VC,5
	850	208-230/460	56HZ	X528	56T8O5306	✓	\$614	F1	5.1-5.3/2.65	49	17.06	5/8 x 5	VC,5
1 1/2	1140	208-230/460	56HZ	K1486	5K48TN6119S		\$473	F1	5.1-5.0/2.5	38	16.77	5/8 X 6	46
	1140	208-230/460	56HZ	X523	56T11O5306	✓	\$501	F1	5.45-5.4/2.7	36	15.68	5/8 x 5	VC,5
	850	208-230/460	56HZ	X531	56T8O15504	✓	\$668	F1	7.0-7.0/3.5	47	16.68	5/8 x 5	VC,5
2	1140	208-230/460	56HZ	X525	56T11O5310	✓	\$543	F1	7.2-6.8/3.4	47	16.68	5/8 x 5	VC,5

Condenser Fan/Heat Pump, Three Phase

Open Air Over, Belly Band/Resilient Ring

Applications:

Commercial condenser fans may be installed outdoors. These motors need to be mounted within the airflow of the fan for proper cooling. Used on Trane, Carrier, Climatrol and York units, 5 tons and larger.

Features:

- 70°C ambient (except as noted)
- Enclosed shaft end bracket, vented frame
- Automatic reset thermal protector
- Nameplate 60/50 hertz 190/380 volts, at next lower HP (except as noted)
- Double sealed ball bearings
- 5/8" Dia. x 5" long shaft with flat and keyway
- Ball bearings
- Threaded lead exit
- Patented VCD™ - Voltage Change Device
- 4 Locating screws 90 degrees apart, 3.33" from outer edge of shaft slinger
- Hubs on both ends will accept resilient base kits, see Accessories section (except X524 and X526 - horizontal only)
- UL Recognized and CSA Certified
- External shaft slinger on all, internal slinger on 5K models



HP	RPM	VOLTS	FRAME	CAT. NO.	MODEL NO.	STOCK	LIST PRICE	MULT. SYMB.	F.L. AMPS	WEIGHT	FRAME LENGTH	SHAFT DIM.	FOOT NOTES
1/3	850	208-230/460	56Y	X511	56T8O5303	✓	\$493	F1	2.3-2.5/1.25	23	9 1/2	VC	
1/2	1140	200-230/460	56Y	X500	56T11O5300	✓	\$392	F1	2.4-2.7/1.35	21	9.00	VC	
	1140	575	56Y	K1500	5K49MN6432S	✓	\$467	F1	1.0	27	9.49	33,46	d
3/4	1140	208-230/460	56Y	K378	5K46LN6033S	✓	\$410	F1	3.0-3.4/1.7	25	8.89	d,46	d
	1140	200-230/460	56Y	X501	56T11O5301	✓	\$434	F1	3.1-3.2/1.6	24	9.50	VC	45
	1140	575	56Y	K1505	5K46LN6428S	✓	\$490	F1	1.5	25	8.89	33,46	
	850	208-230/460	56Y	X506	56T8O5301	✓	\$574	F1	3.6-3.6/1.8	39	11.00	VC	45
1	1140	208-230/460	56Y	K379	5K49RN6034S	✓	\$429	F1	4.2-4.0/2.0	33	10.02	46	
	1140	200-230/460	56Y	X502	56T11O5302	✓	\$455	F1	4.0-4.2/2.1	28	10.00	VC	d
	1140	575	56Y	X522	56T11O5308	✓	\$427	F1	1.7	28	10.00	70	45
	1140	575	56Y	K1510	5K49RN6429S	✓	\$427	F1	1.6	33	16.02	d,33,46	
	850	208-230/460	56Y	K1482	5K48WN3013S	✓	\$563	F1	5.1-5.2/2.6	44	10.77	46	
	850	200-230/460	56Y	X507	56T8O5302	✓	\$597	F1	5.3-5.3/2.6	46	12.00	VC	
	850	575	56Y	K1511	5K48WN3181S	✓	\$563	F1	2.0	44	10.77	d,33,46	
	850	575	56Y	X527	56T8O5304	✓	\$597	F1	2.1	46	12.00	70	
1 1/2	1140	200-230/460	56Y	X503	56T11O5303	✓	\$497	F1	5.5-5.4/2.7	35	11.00	VC	
	1140	575	56Y	X524	56T11O5307	✓	\$497	F1	2.2	35	11.00	73	
	1140	575	56Y	K1515	5K48TN6430S	✓	\$467	F1	2.2	38	10.77	d,33,46	
	850	208-230/460	56Y	X530	56T8O5307	✓	\$643	F1	7.5-6.8/3.4	47	11.25	VC	
2	1140	208-230/460	56Y	X509	56T11O5304	✓	\$539	F1	7.2-6.8/3.4	49	12.00	VC	
	1140	575	56Y	K1520	5K49ZN6433S	✓	\$497	F1	2.5	49	11.97	d,33,46	
	1140	575	56Y	X526	56T11O5309	✓	\$539	F1	2.7	45	11.63	73	

Shaft Up with Fan Canopy / Rainshield

HP	RPM	VOLTS	FRAME	CAT. NO.	MODEL NO.	STOCK	LIST PRICE	MULT. SYMB.	F.L. AMPS	WEIGHT	FRAME LENGTH	SHAFT DIM.	FOOT NOTES
1/2	1140	200-230/460	48Y	K1403	5K36PN345S	✓	\$465	F1	2.2-2.6/1.3	20	7.95	46	
3/4	1140	200-230/460	48Y	K1404	5K38SN267S	✓	\$489	F1	3.3-3.8/1.9	24	8.95	46	
	1140	575	48Y	K1405	5K39SNB765T	✓	\$519	F1	1.5	21	8.50	46	d
1	1140	200-230/460	48Y	K1402	5K39SNB505S	✓	\$539	F1	4.4-4.0/2.0	21	8.50	46	d
1 1/2	1140	200-230/460	48Y	K1407	5K39SNB587S	✓	\$590	F1	6.0-5.8/2.9	21	10.63	46	45

Fan and Blower - Direct Drive, PSC Open Air Over, Resilient Ring, Thru-Bolt Mount

Features:

- Open frames and brackets (except X011 and X012 have enclosed shaft end bracket)
- Single and multi-speed models as noted
- Grommated lead exit
- Weather resistant reversing plug
- 2-1/4" resilient ring mounting except where noted (base not included, see Accessories section)
- 2 1/2" adapter rings supplied, shipped loose in box
- Extended thru-bolts on shaft end
- 30" long leads
- Automatic reset thermal protector
- Ball bearings
- UL Recognized and CSA Certified
- Capacitor not included, see Accessories section



X001



X211



X242



X219



X033

HP	RPM	VOLTS	FRAME	CAT. NO.	MODEL NO.	STOCK	LIST PRICE	MULT. SYMB.	F.L. AMPS	WEIGHT	FRAME LENGTH	SHAFT DIM.	FOOT NOTES
1/5	1075/3	115	48Y	X219	48A11O2047	✓	\$132	F1	3.5	11	4	1/2 x 4	39
1/4	1625/3	115	48Y	X013	48A17O152	✓	\$145	F1	2.9	12	5	1/2 x 4	32
	1625/3	208-230	48Y	X014	48A17O154	✓	\$147	F1	1.8-1.35	11	4 1/4	1/2 x 4	32
	1625/1	208-230	48Y	X012	48A17O2006	✓	\$147	F1	1.8-1.8	12	4 1/2	1/2 x 6	34,44
	1075/3	115	48Y	X000	48A11O1798	✓	\$139	F1	3.4	12	4 1/4	1/2 x 4	32
	1075/3	208-230	48Y	X001	48A11O1799	✓	\$143	F1	1.5-1.5	12	4 1/2	1/2 x 4	32
	1075/3	277	48Y	X018	48A11O1350	✓	\$149	F1	1.6	11	4 1/4	1/2 x 4	32
	1075/1	208-230	48Y	X006	48A11O2001	✓	\$137	F1	2.0-2.0	11	4 1/4	1/2 x 4	32
	1075/1	208-230	48Y	X417	48A11O2051	✓	\$146	F1	2.0-2.2	13	4 1/4	1/2 x 6	51,116
1/3	1625/3	115	48Y	X015	48A17O151	✓	\$154	F1	4.0	13	4 3/4	1/2 x 4	32
	1625/3	208-230	48Y	X011	48A17O2005	✓	\$158	F1	2.3-2.3	14	4 3/4	1/2 x 6	34,44
	1075/4	115	48Y	X236	48A11O699	✓	\$173	F1	6.4	16	4 3/4	1/2 x 6	39
	1075/4	208-230	48Y	X237	48A11O694		\$176	F1	4.8-4.8	16	5 1/4	1/2 x 6	39
	1075/3	115	48Y	X002	48A11O1769	✓	\$149	F1	4.6	14	4 3/4	1/2 x 4	32
	1075/3	208-230	48Y	X003	48A11OB2042	✓	\$152	F1	3.3-3.3	14	4 3/4	1/2 x 4	32
	1075/3	277	48Y	X019	48A11O1351	✓	\$159	F1	2.7	15	4 3/4	1/2 x 4	32
	1075/2	460	48Y	X037	48A11O1876	✓	\$299	F1	1.0	14	4 3/4	1/2 X 6	51
	1075/1	208-230	48Y	X418	48A11O2052	✓	\$155	F1	3.1-3.1	14	4 1/2	1/2 x 6	51,116
	825/1	230	48Y	X209	48A8O183	✓	\$190	F1	2.8	17	5 3/4	1/2 x 5 1/2	34,43
1/2	1625/3	115	48Y	X016	48A17O153	✓	\$172	F1	5.0	16	5 1/4	1/2 x 4	32
	1625/3	208-230	48Y	X017	48A17O155	✓	\$174	F1	4.1-4.1	16	5 1/4	1/2 x 4	32
	1075/4	115	48Y	X033	48A11O1674	✓	\$145	F1	6.1	15	5	1/2 x 5	31,73
	1075/3	115	48Y	X004	48A11O1755	✓	\$168	F1	6.2	17	5 1/2	1/2 x 4	32
	1075/3	208-230	48Y	X005	48A11O1756	✓	\$170	F1	2.65-2.6	17	5 1/2	1/2 x 4	32
	1075/3	277	48Y	X020	48A11O1352	✓	\$177	F1	3.6	17	5 1/2	1/2 x 4	32
	1075/1	208-230	48Y	X419	48A11O2053		\$173	F1	4.2	17	5 1/4	1/2 x 6	51,116
3/4	1625/3	230	48Y	X022	48A17O174	✓	\$191	F1	3.7	18	5 1/2	1/2 x 5 1/2	39,43
	1075/4	208-230	48Y	X241	48A11O697	✓	\$223	F1	5.4-5.4	17	5 1/2	1/2 x 6	39
	1075/3	115	48Y	X009	48A11O787	✓	\$196	F1	10.2	20	5 3/4	1/2 x 4	32
	1075/3	208-230	48Y	X010	48A11O2046	✓	\$199	F1	5.6	19	5 1/2	1/2 x 4	32
	1075/3	277	48Y	X021	48A11O1353	✓	\$204	F1	5.0	20	5 3/4	1/2 x 4	32
1	1625/2	208-230	48Y	X211	48A17O125	✓	\$248	F1	6.2	20	6 1/4	1/2 x 2 1/2	39,42,43
	1075/3	230	48Y	X023	48A11O1583	✓	\$227	F1	5.3	24	6 1/2	1/2 x 5	34
	1075/3	208-230	48YZ	X242	48A11O756	✓	\$377	F1	6.2	26	7 1/4	5/8 x 4	39,51

Fan and Blower - Direct Drive, PSC Open Air Over, Resilient Ring

Applications:

Single speed PSC motors designed to replace PSC and Shaded pole motors, used in direct drive furnace, air conditioners, and others blowers.

Features:

- Open frame and brackets
- Heavy gauge steel frame and base
- Shaft with flat
- 70°C ambient
- 37" Leads
- Thermal overload protection
- 1/4" terminals on the capacitor leads
- 2 1/4" resilient rings, includes 2 1/2" expanders
- Capacitor not included, see Accessories section



HP	RPM	VOLTS	FRAME	CAT. NO.	MODEL NO.	STOCK	LIST PRICE	MULT. SYMB.	F.L. AMPS	WEIGHT	FRAME LENGTH	SHAFT DIM.	FOOT NOTES
1/6	1625	115	48Y	X477	48A17O128	√	\$138	F1	2.6	9	4	1/2 x 4	
	1625	230	48Y	X475	48A17O123	√	\$138	F1	1.3	9	4	1/2 x 4	
	1075	115	48Y	X473	48A11O1046	√	\$133	F1	2.9	9	4	1/2 x 4	
	1075	230	48Y	X471	48A11O1044	√	\$133	F1	1.3	10	4	1/2 x 4	
1/4	1625	230	48Y	X476	48A17O124	√	\$147	F1	1.8	10	4 1/4	1/2 x 4	
	1075	115	48Y	X472	48A11O1045	√	\$139	F1	4.0	11	4 1/4	1/2 x 4	
	1075	230	48Y	X474	48A11O1047	√	\$139	F1	2.0	11	4 1/4	1/2 x 4	

Fan and Blower - Direct Drive, PSC Open Air Over, Torsion Flex Mount

Applications:

Residential and commercial furnaces, air conditioners, exhaust fans, and other air handling equipment installed in clean and dry environments.

Features:

- Open frames and brackets
- Three lug mount fits 9" or 10" bolt circle. Mounting holes on lugs are .435" dia., with grommets and sleeves for .26" dia. option.
- Multi-speed capacity
- Weather resistant reversing plug
- 30" long leads
- Automatic reset thermal protector
- Ball Bearings
- UL Recognized and CSA Certified
- Capacitor not included, see Accessories section



HP	RPM	VOLTS	FRAME	CAT. NO.	MODEL NO.	STOCK	LIST PRICE	MULT. SYMB.	F.L. AMPS	WEIGHT	FRAME LENGTH	SHAFT DIM.	FOOT NOTES
1/4	1075/4	115	48Y	X034	48A11O1773	√	\$160	F1	3.3	14	4 1/2	1/2 x 6	
1/3	1075/4	115	48Y	X035	48A11O1774	√	\$172	F1	4.5	15	4 1/2	1/2 x 6	
1/2	1075/4	115	48Y	X036	48A11O1772	√	\$190	F1	6.0	19	5	1/2 x 6	

Fan & Blower - Direct Drive, PSC Open Air Over, Extended Thru-Bolt, 460 Volt

Applications:

Residential and commercial furnaces, air conditioners, exhaust fans, and other air handling equipment installed in clean and dry environments.

Features:

- Enclosed frame and open end brackets
- Multi-speed capability
- Grommeted lead exit
- Weather resistant reversing plug
- Automatic reset thermal protector
- 7/8" extended thru-bolts on shaft end
- Ball Bearings
- UL Recognized and CSA Certified
- Capacitor not included, see Accessories section



HP	RPM	VOLTS	FRAME	CAT. NO.	MODEL NO.	STOCK	LIST PRICE	MULT. SYMB.	F.L. AMPS	WEIGHT	FRAME LENGTH	SHAFT DIM.	FOOT NOTES
1/3	1075/2	460	48Y	X037	48A11O1876	√	\$299	F1	1.0	14	4 3/4	1/2 X 6	51
1/2	1075/2	460	48Y	X038	48A11O1874	√	\$305	F1	1.6	17	5 1/4	1/2 X 6	51
3/4	1075/2	460	48Y	X039	48A11O1875	√	\$311	F1	2.1	19	5 1/2	1/2 X 6	51

Fan and Blower - Direct Drive, PSC, Open Air Over Belly Band Thru-Bolt, Double Shaft

Applications:

Continuous air over applications, such as room air conditioners, fan coil units, and other air moving applications.

Features:

- Open frame and brackets
- Multi-speed capability
- Automatic reset thermal protector
- 30" leads
- CCW rotation, fixed lead end
- 1" extended Thru-bolts both ends
- 20" overall length
- Length adapter kits included where noted
- Ball Bearings (except as noted)
- UL Recognized and CSA Certified
- Capacitor not included, see Accessories section



HP	RPM	VOLTS	FRAME	CAT. NO.	MODEL NO.	STOCK	LIST PRICE	MULT. SYMB.	F.L. AMPS	WEIGHT	FRAME LENGTH	SHAFT DIM.	FOOT NOTES
1/8	1075/3	115	48Y	X064	48A11O2011		\$132	F1	2.4	11	4	8 1/5 x 1/2 x 7 7/8	4
	1075/3	115	48Y	X056	48A11O901	✓	\$146	F1	2.4	13	4	8 1/5 x 1/2 x 7 7/8	4,71
	1075/3	208-230	48Y	X065	48A11O2012	✓	\$132	F1	1.0	11	4	8 1/5 x 1/2 x 7 7/8	
	1075/3	208-230	48Y	X057	48A11O900		\$146	F1	1.0	33	4	8 1/5 x 1/2 x 7 7/8	4,71
1/6	1075/3	115	48Y	X048	48A11O772		\$133	F1	3.0	14	4	8 1/5 x 1/2 x 7 7/8	4
	1075/3	115	48Y	X042	48A11O653	✓	\$149	F1	3.0	11	4	8 1/5 x 1/2 x 7 7/8	71
	1075/3	208-230	48Y	X049	48A11O773	✓	\$133	F1	1.5	9	4	8 1/5 x 1/2 x 7 7/8	
	1075/3	208-230	48Y	X043	48A11O654	✓	\$149	F1	1.5	11	4	8 1/5 x 1/2 x 7 7/8	71
1/4	1625/3	208-230	48Y	X059	48A17O2002		\$147	F1	1.8	12	4 1/4	8 x 1/2 x 7 7/8	
	1625/3	208-230	48Y	X040	48A17O69	✓	\$163	F1	1.8	12	4 1/4	8 x 1/2 x 7 7/8	71
	1075/3	115	48Y	X061	48A11O2022	✓	\$159	F1	4.8	14	4 1/4	8 x 1/2 x 7 7/8	71
	1075/3	208-230	48Y	X050	48A11O774	✓	\$143	F1	2.2	13	4 1/4	8 x 1/2 x 7 7/8	
	1075/3	208-230	48Y	X044	48A11O655	✓	\$159	F1	2.2	16	4 1/4	8 x 1/2 x 7 7/8	71
1/3	1625/3	208-230	48Y	X060	48A17O2003		\$158	F1	2.5	14	4 3/4	7 1/2 x 1/2 x 7 7/8	4
	1625/3	208-230	48Y	X041	48A17O70	✓	\$172	F1	2.5	15	4 3/4	7 1/2 x 1/2 x 7 7/8	71
	1075/3	115	48Y	X070	48A11O2024	✓	\$168	F1	7.8	15	4 3/4	7 1/2 x 1/2 x 7 7/8	71
	1075/3	208-230	48Y	X052	48A11O775	✓	\$152	F1	3.4	16	4 3/4	7 1/2 x 1/2 x 7 7/8	
	1075/3	208-230	48Y	X045	48A11O656	✓	\$168	F1	3.4	17	4 3/4	7 1/2 x 1/2 x 7 7/8	71
	1075/3	208-230	48Y	X258	48A11O1167	✓	\$147	F1	2.3	14	4 1/4	6 7/8 x 1/2 x 6 7/8	
1/2	1625/3	208-230	48Y	X058	48A17O2001	✓	\$194	F1	4.1	18	5 1/4	7 x 1/2 x 7 7/8	71
	1625/3	208-230	48Y	X069	48A17O2004		\$177	F1	4.1	16	5 1/4	7 x 1/2 x 7 7/8	4
	1075/3	115	48Y	X071	48A11O2026	✓	\$189	F1	9.4	20	5 1/2	6 5/8 x 1/2 x 7 7/8	71
	1075/3	208-230	48Y	X062	48A11O2009	✓	\$189	F1	4.7	17	5 1/2	6 5/8 x 1/2 x 7 7/8	71
	1075/3	208-230	48Y	X067	48A11O2014	✓	\$173	F1	4.7	19	5 1/2	6 5/8 x 1/2 x 7 7/8	
3/4	1075/3	208-230	48Y	X068	48A11O2015		\$197	F1	5.0	15	5 3/4	6 3/4 x 1/2 x 6 7/8	
	1075/3	208-230	48Y	X063	48A11O2028	✓	\$212	F1	5.4	19	5 1/2	6 5/8 x 1/2 x 7 7/8	71

Fan and Blower, Split Phase, Dripproof Resilient Base (Single & Two-Speed)



Features:

- Ball bearings (except as noted)
- Service factor, as noted
- Thermal protection, as noted
- Variable torque on two speed motors
- Extended thru-bolts, as noted
- Heavy gauge steel frame and base
- 48Y and 48YZ frame have 48/56 frame mounting holes
- UL Recognized and CSA certified

HP	RPM	VOLTS	FRAME	OVER LOAD	CAT. NO.	MODEL NO.	STOCK	LIST PRICE	MULT. SYMB.	F.L. AMPS	WEIGHT	"C" DIM.	FOOT NOTES
1/12	1140	115	48Z	AUTO	HG152	5KH32GN140X	✓	\$247	F1	2.4	15	9.32	8,112
1/8	1140	115	48Z	AUTO	HG154	5KH36KN113X	✓	\$273	F1	3.8	17	10.38	8,112
	850	115	56	AUTO	HG155	5KH46MN3021X	✓	\$439	F1	4.6	32	10.88	112
1/6	1725/1140	115	48Z	NONE	H169	5KH36KN114	✓	\$170	F1	3.4/1.9	17	10.38	8,20,54
	1725/1140	115	48Z	AUTO	H170	5KH36KN114X	✓	\$177	F1	3.4/1.9	17	10.38	8,20,54
	1725/1140	115	48	NONE	4322	5KH39QN9548	✓	\$204	F1	3.4/1.9	15	10.00	4,20
	1725/1140	115	48	AUTO	4389	5KH39QN9548X	✓	\$217	F1	3.4/1.9	18	10.00	4,20
	1725	115	48	AUTO	4314	5KH39QN5520X	✓	\$147	F1	3.9	12	8.93	4,20
	1725	115	48Y	AUTO	D107	48S17D2017	✓	\$151	F1	3.6	12	8.99	CF,4,20
	1725	115	48	NONE	4304	5KH39QN5543	✓	\$146	F1	3.9	12	8.93	4,20
	1725	115	48Z	AUTO	H913	5KH32DNA700X	✓	\$155	F1	4.4	12	9.74	9,20,28
	1725	115	48Z	NONE	HG156	5KH32DN3085	✓	\$143	F1	3.9	12	9.32	8,20
	1725	115	48Z	NONE	H912	5KH32DNA700	✓	\$105	F1	4.4	12	9.74	9,20,28
	1725	115	48YZ	NONE	B300	48S17D2052	✓	\$145	F1	3.6	13	9.32	CF,20,31,52
	1725	115	48Z	AUTO	H157	5KH32DN3085X	✓	\$151	F1	3.9	12	9.32	8,20
	1725	115	48YZ	AUTO	B322	48S17D2053	✓	\$153	F1	3.6	13	9.32	CF,20,31,52
	1725	115	56Z	AUTO	4350	5KH39QN5538X	✓	\$154	F1	3.9	13	9.19	4,8,20,26
	1140	115	48	NONE	H112	5KH37PN39	✓	\$242	F1	4	20	10.40	4,20
	1140	115	48Z	AUTO	H159	5KH37PN41X	✓	\$300	F1	4	21	10.78	8,20
	1140	115	48	NONE	HG695	5KH37PNA233	✓	\$244	F1	4	24	10.40	4,20
	1140	115	48Z	NONE	H158	5KH37PN41	✓	\$293	F1	4	21	10.78	8,20
	1140	115	48	AUTO	HG113	5KH37PN39X	✓	\$250	F1	4	20	10.40	4,20
	850	115	56	NONE	H620	5KH49PN3043	✓	\$487	F1	6.1	31	11.48	20
1/4	1725/1140	115	48Y	AUTO	D180	48S17D7204	✓	\$185	F1	4.1/2.5	18	10.06	4,20
	1725/1140	115	48Z	AUTO	H172	5KH37PN33X	✓	\$203	F1	4.2/2.7	21	10.69	8,20,54
	1725/1140	115	48Z	NONE	H171	5KH37PN33	✓	\$196	F1	4.2/2.7	21	10.69	82,054
	1725/1140	115	48	AUTO	4399	5KH39QN9551X	✓	\$250	F1	4.2/2.7	22	10.40	4,20,54
	1725/1140	115	56Z	AUTO	HG704	5KH35MNA568T	✓	\$255	F1	5.2/2.8	17	10.18	17,20,48
	1725/1140	230	48	AUTO	4412	5KH39QN9550X	✓	\$281	F1	2.1/1.3	22	10.40	4,20,39
	1725	115	48	AUTO	4305	5KH39QN5511X	✓	\$130	F1	5.1	13	8.93	4,20
	1725	115	48	NONE	4355	5KH39QN5225	✓	\$154	F1	5.1	13	8.93	4,20
	1725	115	48Y	AUTO	4701	5KH39QN5512T	✓	\$128	F1	5.1	12	9.12	4,20,47
	1725	115	48YZ	AUTO	B206	48S17D2107	✓	\$134	F1	5	14	9.62	CF,4,20,53
	1725	115	48Z	NONE	H160	5KH32FN3083	✓	\$153	F1	5.1	14	9.32	8,20
	1725	115	48YZ	NONE	B302	48S17D2054	✓	\$156	F1	5	14	9.57	CF,20,31,52
	1725	115	48Z	AUTO	H915	5KH33FNA722X	✓	\$167	F1	5.6	14	9.99	9,20,28
	1725	115/230	48Y	AUTO	4702	5KH33HN5725X	✓	\$162	F1	5.2/2.6	15	9.62	4,7,20,26
	1725	115	48Y	AUTO	HG701	5KH32DN5618X	✓	\$139	F1	5.1	13	8.94	4,20,48
	1725	115/208-230	48Z	AUTO	4680	5KH32FN3120T	✓	\$219	F1	5.0/2.5	13	9.94	9,20
	1725	115	48Z	AUTO	HG161	5KH32FN3083X	✓	\$160	F1	5.1	14	9.32	8,20
	1725	115	48YZ	AUTO	B303	48S17D2055	✓	\$163	F1	5	14	9.57	CF,20,31,52
	1725	115	56Z	AUTO	B201	56S17D2047	✓	\$134	F1	5	14	9.47	20,32,53
	1725	115	56Z	AUTO	4363	5KH39QN5526X	✓	\$176	F1	5.1	14	9.19	4,8,20,26
	1725	230	48	AUTO	4306	5KH39QN5537X	✓	\$139	F1	2.5	13	9.09	4,20
	1725	230	48	NONE	4360	5KH39QN5548	✓	\$170	F1	2.5	13	8.93	4,20
	1725	277	48YZ	NONE	B606	48S17D2116	✓	\$174	F1	2.1	13	9.47	20,31,52
	1140/850	115	56	NONE	H300	5KH49SN3048	✓	\$514	F1	5.8/3.6	30	12.01	20,31
	1140	115	56	AUTO	H163	5KH46MN6053X	✓	\$356	F1	5.6	23	10.88	20
	1140	115	56	NONE	H162	5KH46MN6053	✓	\$348	F1	5.6	27	10.88	20
	850	115	56	NONE	H296	5KH49SN3046	✓	\$598	F1	6.9	30	12.01	19
1/3	3450	115	48	NONE	H114	5KH35FN124	✓	\$198	F1	5.6	15	9.57	20
	3450	115	48	AUTO	HG115	5KH35FN124X	✓	\$211	F1	5.6	15	9.57	20
	3450	115/230	48Z	AUTO	4798	5KH35FN153T	✓	\$230	F1	6.8/3.4	13	10.25	9,20

Fan and Blower, Split Phase, Dripproof Resilient Base (Single & Two-Speed)

HP	RPM	VOLTS	FRAME	OVER LOAD	CAT. NO.	MODEL NO.	STOCK	LIST PRICE	MULT. SYMB.	F.L. AMPS	WEIGHT	"C" DIM.	FOOT NOTES	
1/3	1725/1140	115	48	AUTO	4319	5KH39QN9429T	✓	\$256	F1	6.3/3.1	22	10.40	4,17,54	
	1725/1140	115	48	NONE	4396	5KH39QN9683	✓	\$246	F1	6.3/3.1	21	10.40	4,17,54	
	1725/1140	115	48Y	AUTO	D181	48S17D7205		\$230	F1	5.3/2.9	20	10.06	4,20	
	1725/1140	115	56	NONE	H173	5KH46MN3025	✓	\$247	F1	5.7/3.2	24	10.88	20,31	
	1725/1140	115	56	AUTO	H174	5KH46MN3025X	✓	\$254	F1	5.7/3.2	32	10.88	20,31	
	1725/1140	115	56Z	AUTO	HG706	5KH37PNA569T	✓	\$292	F1	6.0/3.8	20	11.01	17,48	
	1725/850	115	56Z	AUTO	HG705	5KH46NN3039T	✓	\$444	F1	4.7/2.6	25	10.90	17,48	
	1725	115	48Y	AUTO	D143	48S17D2086	✓	\$152	F1	6.1	15	9.34	20	
	1725	115	48Y	AUTO	B703	48N17D14	✓	\$204	F1	3.2	17	9.84	20,74	
	1725	115	48Y	AUTO	HG711	5KH32HN5620T	✓	\$149	F1	6.6	14	8.94	4,20,26,48	
	1725	115	48Y	AUTO	HG700	5KHC37NNA167T	✓	\$261	F1	3.7	24	10.39	ES,20,26,47	
	1725	115	48Y	AUTO	4706	5KH39QN5514T	✓	\$142	F1	6.6	15	9.12	4,20,47	
	1725	115	48YZ	AUTO	B207	48S17D2108	✓	\$152	F1	5.5	15	9.62	CF,4,20,53	
	1725	115	48Z	NONE	H164	5KH32JN3128	✓	\$177	F1	6.2	15	9.32	8,20	
	1725	115	48YZ	NONE	B304	48S17D2056	✓	\$180	F1	5.5	15	9.32	CF,20,31,52	
	1725	115	48Z	AUTO	H917	5KH35JNA723X		\$190	F1	6.9	15	10.37	9,20,28	
	1725	115	48Z	AUTO	H165	5KH32JN3128X	✓	\$183	F1	6.2	16	9.32	8,20	
	1725	115	48YZ	AUTO	B305	48S17D2057	✓	\$186	F1	5.5	15	9.32	CF,20,31,52	
	1725	115	56Z	AUTO	B202	56S17D2048	✓	\$156	F1	6.1	15	9.72	20,32,53	
	1725	230	48Z	AUTO	H167	5KH35JN26X	✓	\$160	F1	3.3	16	9.95	8,20	
	1725	230	48	AUTO	4309	5KH39QN9514X	✓	\$232	F1	3.1	15	9.18	20	
	1725	115	48	NONE	4370	5KH39QN9682	✓	\$213	F1	6.2	15	9.18	20	
	1725	115/230	48Y	AUTO	4707	5KH33HN5722X	✓	\$181	F1	6.0/3.0	15	9.12	4,7,20,26	
	1725	115/208-230	56Z	AUTO	4682	5KH35JN3132T	✓	\$246	F1	6.2/3.1	16	10.26	9,20,26,72	
	1725	230	48Z	NONE	H166	5KH35JN26	✓	\$235	F1	3.3	16	9.95	8,20	
	1725	230	56Z	AUTO	4757	5KH39QN9636T	✓	\$243	F1	3.1	16	9.19	7,20,26	
	1725	277	48YZ	NONE	B607	48S17D2117	✓	\$196	F1	2.5	15	9.72	20,31,52	
	1725	115	56Z	AUTO	4383	5KH39QN9513X	✓	\$228	F1	6.2	15	9.19	8,26	
	1140	115/230	56	NONE	H168	5KH49PN6055	✓	\$404	F1	7.0/3.5	27	11.48	20	
	1140	115/230	56	AUTO	HG621	5KH49PN6055X	✓	\$419	F1	7.0/3.5	26	11.48	20	
	1/2	1725/1140	115	56	NONE	H175	5KH49PN3026	✓	\$312	F1	8.0/4.2	31	11.48	19,31
		1725/1140	115	56	AUTO	H176	5KH49PN3026X	✓	\$319	F1	8.0/4.2	31	11.48	19,31
		1725/1140	115	56	NONE	H130	5KH39QN9632	✓	\$350	F1	8.4/4.8	22	10.32	17
		1725/1140	115	56	AUTO	H131	5KH39QN9631T	✓	\$362	F1	8.4/4.8	22	10.32	17,31
		1725/1140	115	56Z	AUTO	HG715	5KH38SNA731T	✓	\$412	F1	7.8/4.8	25	11.44	17,48
		1725/1140	230	56	NONE	H275	5KH49PN3045	✓	\$436	F1	3.8/1.9	28	11.48	19,31
		1725/1140	230	56	AUTO	H133	5KH39QN9642T	✓	\$378	F1	4.1/2.4	22	10.32	17,31
		1725	115	48Y	AUTO	D162	48S17D2087	✓	\$207	F1	7.2	19	10.09	19
		1725	115	48Y	AUTO	HG703	5KH35MNA519T	✓	\$200	F1	7.9	15	10.32	19,48
		1725	115	48Y	AUTO	4708	5KH39QN9401T	✓	\$188	F1	7.9	17	9.93	4,19,47
1725		115	48YZ	AUTO	B208	48S17D2109	✓	\$207	F1	7.5	20	10.43	CF,4,19,53	
1725		115	48YZ	NONE	B306	48S17D2058	✓	\$218	F1	7.5	18	10.32	CF,19,31,52	
1725		115	48	AUTO	HG694	5KH39QN9767X	✓	\$231	F1	7.1	19	9.99	19	
1725		115	48YZ	AUTO	B307	48S17D2059	✓	\$237	F1	7.5	18	10.32	CF,19,31,52	
1725		115	48Z	AUTO	H919	5KH36MNA735X		\$234	F1	8.7	18	10.80	10,19,28	
1725		115	56	AUTO	4392	5KH39QN9405X	✓	\$230	F1	7.9	21	10.32	19	
1725		115	56	NONE	4390	5KH39QNA039	✓	\$258	F1	7.9	17	10.32	19	
1725		115	56	AUTO	D149	56S17D2050	✓	\$212	F1	7.2	19	10.47	19	
1725		115	56	AUTO	H248	5KH36MN3106X	✓	\$262	F1	9.3	18	10.32	19	
1725		115	56	NONE	H286	5KH36MN3106	✓	\$258	F1	9.3	18	10.32	19	
1725		115	56Z	AUTO	B200	56S17D2049	✓	\$212	F1	7.2	19	10.47	19,32,53	
1725		115	56Z	AUTO	4758	5KH39QN9698T	✓	\$269	F1	7.9	22	9.99	7,19,26	
1725		115/230	48Y	AUTO	4709	5KH36MN5729X	✓	\$220	F1	7.6/3.8	18	9.93	1,4,7,19	
1725		115/230	56	AUTO	B100	56S17D2064	✓	\$223	F1	7.2/3.6	20	10.47	19	
1725		115/230	56Z	AUTO	4684	5KH36MN3127T	✓	\$304	F1	8.9/4.5	18	10.69	9,26	
1725		230	56	AUTO	4393	5KH39QN9544X	✓	\$281	F1	4.5	21	10.32	19	
1725		230	48Y	AUTO	D163	48S17D2088	✓	\$217	F1	3.6	19	10.09	19	
1140		115/230	56	AUTO	H298	5KH48UN6054X	✓	\$536	F1	9.0/4.5	32	12.76	19	
3/4		1725	115	56	AUTO	4338	5KH39QN9541T	✓	\$275	F1	11.4	21	10.72	18



Fan and Blower - Capacitor Start, Dripproof Resilient Base (Single & Two-Speed)



Features:

- Ball bearings
- Heavy gauge steel frame and base
- Service Factor, as noted
- Capacitor start / capacitor run as noted
- Thermal protection, as noted
- 48Y and 48YZ Frame have 48/56 Frame mounting holes
- UL Recognized and CSA Certified

HP	RPM	VOLTS	FRAME	OVER LOAD	CAT. NO.	MODEL NO.	STOCK	LIST PRICE	MULT. SYMB.	F.L AMPS	WEIGHT	"C" DIM.	FOOT NOTES
1/4	1725	115/230	48	NONE	G1114	5KC35JN7J	✓	\$173	F1	5.2/2.6	16	9.57	20
	1725	115/208-230	48YZ	AUTO	B313	48C17D2042	✓	\$203	F1	5.2/2.8-2.6	16	9.95	CF,20,31,52
	1725	115/208-230	48YZ	NONE	B312	48C17D2041	✓	\$194	F1	6.2/2.8-3.1	15	9.72	20,31,52
	1725	115/230	48	AUTO	G1115	5KC35JN7X	✓	\$183	F1	5.2/2.6	16	9.57	20
1/3	1725	115/208-230	48YZ	NONE	B314	48C17D2043	✓	\$229	F1	5.8/3.1-2.9	18	10.22	20,31,52
	1725	115/208-230	48YZ	AUTO	B315	48C17D2044	✓	\$237	F1	5.8/3.1-2.9	17	10.22	20,31,52
	1725	115/208-230	56	AUTO	C216	5KC36LN1X	✓	\$241	F1	6.0/3.2-3.0	18	10.32	20,50
	1725	115/230	48YZ	AUTO	D119	48C17D2055	✓	\$218	F1	5.8/2.9	12	10.22	20,31,52
	1725	115/230	56	AUTO	G135	56C17D2088	✓	\$221	F1	6.4/3.2	18	10.22	20
	1/2	3450	115/208-230	48	AUTO	C1152	5KC39QN3220X	✓	\$175	F1	8.2/3.9-4.1	19	11
	1725/1140	115	56	AUTO	C419	5KC49PN3027X	✓	\$499	F1	8.2/3.9	28	11.38	19
	1725	115/208-230	56	NONE	B1316	5KC49GN0001	✓	\$259	F1	8.8/4.2-4.4	21	10.38	19
	1725	115/208-230	56	AUTO	C1153	5KC49GN0022X	✓	\$293	F1	8.6/4.1-4.3	21	10.38	19
	1725	115/208-230	56	AUTO	B317	56C17D2072	✓	\$299	F1	8.0/4.1-4.0	20	10.32	CF,19,31
	1725	115/208-230	56Y	AUTO	B353	56B17D67	✓	\$320	F1	6.2/3-3.1	24	12.92	1,19,55
	1725	115/230	56	AUTO	D111	56C17D2079	✓	\$263	F1	7.2/3.6	20	10.72	19
	1725	115/230	56	AUTO	G151	56C17D2025	✓	\$263	F1	8.6/4.3	24	11.72	19
	1725	277	56	NONE	B608	56C17D2113	✓	\$296	F1	3.6	23	11.72	19
3/4	3450	115/208-230	56	AUTO	C1155	5KC38NN410X	✓	\$229	F1	10.0/4.9-5.0	17	11.32	19
	3450	115/208-230	48	AUTO	C1154	5KC38NN413X	✓	\$322	F1	9.8/5.0-4.9	17	11	19
	1725/1140	115	56	AUTO	B332	56B17D5701	✓	\$473	F1	8.9/6.1	40	12.85	1,19,31
	1725/1140	115	56	NONE	C420	5KCR49PN3011	✓	\$463	F1	9.0/6.4	31	11.48	ES,1,19
	1725/1140	208-230	56	NONE	C486	5KCR49PN3012X	✓	\$472	F1	4.3-4.4/3.1-3.2	38	11.48	ES,1,19
	1725/1140	115	56	AUTO	C474	5KCR49PN3011X	✓	\$545	F1	9.0/6.4	31	11.48	ES,1,19
	1725	115/208-230	56	AUTO	C1156	5KC46LN0149X	✓	\$353	F1	13.3/6.5-6.6	27	10.78	19
	1725	115/208-230	56	AUTO	B319	56C17D2074	✓	\$363	F1	10.0/5.2-5.0	23	10.72	CF,19,31
	1725	115/208-230	56	NONE	CG230	5KC46LN0158	✓	\$326	F1	13.2/6.2-6.6	25	10.78	19
	1725	115/208-230	56	NONE	B318	56C17D2073	✓	\$337	F1	10.0/5.2-5.0	24	10.72	CF,19,31
	1725	115/208-230	56	NONE	G156	56B17D2012	✓	\$324	F1	11.0/5.5-5.5	26	11.47	1,19
	1725	115/208-230	56Z	AUTO	4686	5KC46LN0269X	✓	\$385	F1	13.3/6.5-6.6	25	11.15	10,19
	1725	115/230	56	AUTO	D1113	5KC46LN0158X	✓	\$325	F1	13.2/6.6	25	10.78	19
	1725	277	56	NONE	B609	56B17D2013	✓	\$360	F1	4.3	27	11.47	1,19,31
1	3450	115/208-230	56	AUTO	C1157	5KC39RN383X	✓	\$284	F1	13.4/6.7-6.6	25	11.85	19
	3450	115/208-230	56	AUTO	D118	56C34D2106	✓	\$266	F1	12.0/6.2-6.0	25	12.22	18
	1725/1140	115	56	AUTO	B335	56B17D5703	✓	\$589	F1	11.5/7.0	39	12.85	1,18,31
	1725/1140	115	56	NONE	C475	5KCR49SN3009	✓	\$578	F1	10.8/7.4	35	12.01	ES,1,18
	1725/1140	115	56	AUTO	C1478	5KCR49SN3009X	✓	\$604	F1	10.8/7.4	30	12.01	ES,1,18
	1725/1140	208-230	56	NONE	C476	5KCR49SN3010	✓	\$601	F1	5.3-5.4/3.6-3.7	35	12.01	ES,1,18
	1725/1140	208-230/190-380	56H	AUTO	C1479	5KCR48TN3084X	✓	\$613	F1	5.3-5.4/3.6-3.7	36	12.54	ES,1,17
	1725	115/208-230	56	AUTO	C1158	5KC49PN0164X	✓	\$369	F1	14.7/7.2-7.4	29	11.38	18
	1725	115/208-230	56Z	AUTO	4688	5KC49NN0061T	✓	\$374	F1	14.4/7.2-7.4	28	11.75	10,18
	1725	115/208-230	56H	NONE	C235	5KC49PN0155	✓	\$344	F1	13.6/6.7-6.8	31	11.38	18
	1725	277	56	NONE	B337	56C17D5348	✓	\$386	F1	5.6	29	11.85	19,32
	1 1/2	3450	115/208-230	56H	AUTO	C1159	5KC49RN2152T	✓	\$370	F1	19.6/9.8-9.8	33	12.01
3450		115/208-230	56H	AUTO	D115	56B34D2027	✓	\$370	F1	13.4/7.4-6.7	28	11.72	1,18
1725		115/208-230	145T	NONE	I146	145TCDF5331	✓	\$419	S1	18.0/9.3-9.0	42	13.22	18,32
1725		115/208-230	56H	NONE	B336	56C17D5347	✓	\$413	F1	18.0/9.3-9.0	39	12.85	5,18,32
1725		115/208-230	56H	AUTO	C1160	5KCR49SN0150X	✓	\$429	F1	16.4/8.4-8.2	35	11.91	ES,1,18
1725		277	56H	NONE	B338	56C17D5349	✓	\$447	F1	7.5	41	12.85	5,18,32
2	3450	115/208-230	56H	AUTO	C1161	5KCR49RN2148T	✓	\$451	F1	19.6/10.4-9.8	33	11.91	ES,1,110
	1725	115/208-230	56H	AUTO	B352	56B17D5331	✓	\$547	F1	21/11.3-10.5	50	13.85	1,5,32
	1725	115/208-230	145T	NONE	I147	145TBDR5345	✓	\$440	S1	21/11.3-10.5	49	14.22	1,18

Fan and Blower, Split Phase and Capacitor Start Totally Enclosed, Resilient Base (Single & Two-Speed)

Features:

- Thermal protection, as noted
- 1.0 Service Factor (except as noted)
- Heavy gauge steel frame and base
- Split phase (except as noted)
- Ball bearings
- UL Recognized and CSA Certified



HP	RPM	VOLTS	FRAME	OVER LOAD	CAT. NO.	MODEL NO.	STOCK	LIST PRICE	MULT. SYMB.	F.L. AMPS	WEIGHT	"C" DIM.	FOOT NOTES
1/6	1725	115	48	NONE	HG178	5KH32EN79	✓	\$242	F1	4.0	15	9.92	
	1725	115	48	AUTO	H291	5KH32EN72X	✓	\$255	F1	4.0	15	9.92	CF,20,31,52
	1140	115	48	NONE	H233	5KH36PN109	✓	\$335	F1	4.0	23	10.98	
1/4	1725	115	48	AUTO	H234	5KH39QN9105X	✓	\$177	F1	5.1	17	9.92	
	1725	115	48	NONE	B1502	5KH39QN9105	✓	\$170	F1	5.1	17	9.92	
	1725	115/230	48	NONE	C247	5KC32GN13	✓	\$300	F1	5.4/2.7	17	9.92	2
	1725/1140	115	48	NONE	HG189	5KH36PN108	✓	\$335	F1	4.2/2.7	23	10.98	
	1140	115/230	56	NONE	HG182	5KH49MN6060	✓	\$386	F1	5.6/2.8	25	11.54	
1/3	1725	115	56	NONE	B1504	5KH35MN56	✓	\$210	F1	5.9	20	10.93	
	1725	115	56	AUTO	H236	5KH35MN56X	✓	\$217	F1	5.9	20	10.93	
	1725/1140	115	56	NONE	H190	5KH49MN3035	✓	\$416	F1	5.7/3.2	27	11.54	
	1140	115	56	NONE	HG186	5KH46PN6059	✓	\$444	F1	7.0	31	11.94	
1/2	1725	115	56	AUTO	B506	56S17F5303		\$298	F1	8.4	27	12.30	
	1725	115	56	NONE	B1507	5KH42GN0336	✓	\$252	F1	8.0	21	11.11	19
	1725	115/230	56	AUTO	C289	5KC42GN0309X	✓	\$405	F1	8.6/4.3	21	11.11	2,18
	1725/1140	115	56	NONE	HG191	5KH46PN3033	✓	\$463	F1	8.0/4.2	29	11.94	
	1725/1140	230	56	NONE	H293	5KH46PN3034	✓	\$475	F1	3.8/1.9	31	11.94	
	1140	115	56	NONE	HG188	5KH49UN6064	✓	\$565	F1	9.0	40	13.07	
3/4	1725	115/230	56	AUTO	C806	5KC49PN0281X	✓	\$471	F1	11.0/5.5	32	12.54	2,17
1	1725	115/230	56	AUTO	C292	5KC49TN0285X	✓	\$520	F1	13.2/6.6	38	13.07	2

Fan & Blower - Three Phase TEAO, Resilient Base

Applications:

Designed for applications like commercial fans and blowers, direct and belt drive air handlers and exhaust fans.

Features:

- Ball bearings
- 1.0 Service Factor
- .62" extended thru-bolts
- UL Recognized and CSA Certified



HP	RPM	VOLTS	FRAME	CAT. NO.	MODEL NO.	STOCK	LIST PRICE	MULT. SYMB.	F.L. AMPS	WEIGHT	"C" DIM.	FOOT NOTES
1/4	1800	230/460	48	K281	5K32GN48	✓	\$282	F1	1.4/0.7	14	8.94	
	1200	230/460	56	K282	5K35MN294	✓	\$405	F1	1.4/0.7	18	9.89	
1/3	1800	230/460	48	K283	5K33KN52	✓	\$316	F1	1.5/0.8	16	9.19	
1/2	1800	208-230/460	56	K284	5K42HN4128	✓	\$355	F1	2.3-2.2/1.1	22	10.05	
	1200	208-230/460	56	K285	5K49MN6080	✓	\$475	F1	2.6-2.6/1.3	24	10.48	
	1200	208-230/460	56	K541	5K49MN6081	✓	\$514	F1	2.6-2.6/1.3	27	11.54	
3/4	1800	208-230/460	56	K286	5K49KN4142	✓	\$383	F1	3.3-3.0/1.5	21	10.48	
1	1800	208-230/460	56	K525	5K49MN4114	✓	\$402	F1	3.6-3.8/1.9	25	10.48	

Fan & Blower - Three Phase, Dripproof Resilient Base (Single and Two-Speed)

Features:

- Single and two-speed models, as noted
- Variable torque on two speed ratings
- Ball bearings
- Heavy gauge steel frame and base
- Thermal protection, as noted
- Service Factor, as noted
- Nameplated 60/50 Hz at next lower horsepower (except as noted)
- **Patented VCD™**, Voltage Change Device where footnoted "VC"
- UL Recognized and CSA Certified



HP	RPM	VOLTS	FRAME	OVER LOAD	CAT. NO.	MODEL NO.	STOCK	LIST PRICE	MULT. SYMB.	F.L. AMPS	WEIGHT	"C" DIM.	FOOT NOTES
1/4	1800	230/460	48Z	NONE	K275	5K33GN45	✓	\$267	F1	1.4/0.7	14	9.57	20
1/3	1800/1200	460	56	NONE	G161	56T17D5701		\$352	F1	0.6/0.4	33	12.35	20
	1800	208-230/460	56	AUTO	G106	56T17D2104	✓	\$280	F1	1.5-1.6/8	16	9.97	20
	1800	208-230/460	56	NONE	G162	56T17D2121	✓	\$232	F1	1.5-1.6/8	16	9.97	20
1/2	1800	575	56	NONE	G964	56T17D2117		\$232	F1	0.64	16	9.97	20,70
	1800/1200	200-230	56	NONE	K544	5K42JN3051	✓	\$382	F1	2.4-2.8/1.5-1.7	23	10.05	19
	1800/1200	460	56	NONE	K546	5K42JN3050	✓	\$382	F1	1.1/0.6	22	10.05	19
	1800	208-230/460	56	AUTO	K1408	5K42HN4089X	✓	\$310	F1	2.3-2.2/1.1	20	10.05	19
	1800	208-230/460	56	NONE	K381	5K42HN4089	✓	\$262	F1	2.3-2.2/1.1	20	10.05	19
3/4	1800	208-230/460	56	AUTO	G140	56T17D5345	✓	\$324	F1	2.3-2.4/1.2	22	10.85	VC,19
	1800	575	56	NONE	G961	56T17D2118	✓	\$261	F1	0.9	18	10.47	19,70
	3600	208-230/460	56	AUTO	K1409	5K37MN252X	✓	\$284	F1	2.6-2.6/1.3	16	10.72	19
	1800/1200	200-230	56	NONE	K279	5K49PN3053	✓	\$454	F1	2.8-3.0/1.6-1.8	31	11.48	19
	1800/1200	460	56	NONE	K280	5K49PN3052	✓	\$454	F1	1.3/0.7	28	11.48	19
	1800	208-230/460	56	AUTO	K1410	5K46KN4085X	✓	\$339	F1	3.3-3.0/1.5	21	10.88	19
	1800	208-230/460	56	AUTO	G141	56T17D5346	✓	\$354	F1	2.9-3.0/1.5	23	10.85	VC,19
1	1800	208-230/460	56	NONE	K277	5K46KN4085	✓	\$293	F1	3.3-3.0/1.5	25	10.88	19
	1800	575	56	NONE	G962	56T17D2119	✓	\$292	F1	1.1	21	10.97	19,70
	3600	208-230/460	56	AUTO	K1411	5K38PN258X	✓	\$316	F1	3.3-3.2/1.6	18	11.32	19
	1800/1200	200-230	56	NONE	K518	5K49SN3054	✓	\$470	F1	3.7-3.9/2.0-2.2	35	12.01	18
	1800/1200	460	56	NONE	K519	5K49SN3055	✓	\$470	F1	1.8/1.1	35	12.01	18
	1800	208-230/460	56	AUTO	K1412	5K46MN4087X	✓	\$360	F1	3.6-3.8/1.9	27	10.88	d,18
	1800	208-230/460	56	AUTO	G142	56T17D5347	✓	\$360	F1	3.5-3.6/1.8	25	11.35	VC,18
1 1/2	1800	208-230/460	56H	AUTO	G100	56T17D2101	✓	\$346	F1	3.4-3.4/1.7	24	11.47	5,18
	1800	208-230/460	56	NONE	K278	5K46MN4087	✓	\$301	F1	3.6-3.8/1.9	27	10.88	18
	1800	575	56H	NONE	G963	56T17D2120	✓	\$300	F1	1.4	23	11.47	5,18,70
	3600	208-230/460	56H	AUTO	K1413	5K49KN2150X	✓	\$377	F1	5.0-4.8/2.4	26	12.01	18
	1800/1200	200-230	56H	NONE	K520	5K48UN3056	✓	\$484	F1	5.0-5.3/2.8-3.1	40	12.76	18
	1800/1200	460	56H	NONE	K549	5K48UN3057	✓	\$484	F1	2.3/1.4	40	12.76	18
	1800	208-230/460	56	NONE	G122	56T17D5329	✓	\$333	F1	4.8-4.8/2.4	28	11.35	18
	1800	208-230/460	56H	AUTO	K1415	5K49PN4088X	✓	\$378	F1	5.5-5.6/2.8	31	12.01	18
2	1800	208-230/460	56	AUTO	G143	56T17D5348	✓	\$393	F1	4.8-4.8/2.4	28	11.35	VC,18
	1800	208-230/460	145T	AUTO	K2030	5KE49TN8384T	✓	\$409	E6	4.5-4.4/2.2	40	13.19	d,18,70
	1800	575	56H	AUTO	G965	56T17D5357		\$377	F1	1.9	29	11.35	18,70
	3600	208-230/460	56H	AUTO	K1416	5K49NN2147X	✓	\$435	F1	6.0-6.0/3.0	30	12.01	18
	1800	208-230/460	56H	AUTO	G144	56T17D5349	✓	\$435	F1	6.2-6.2/3.1	35	12.35	VC,5,18
	1800	208-230/460	56H	NONE	G127	56T17D5332	✓	\$364	F1	6.2-6.2/3.1	34	12.35	5,18
3	1800	208-230/460	56H	AUTO	K1418	5K49UN4086X	✓	\$412	F1	6.2-6.0/3.0	39	13.96	18
	1800	575	56H	AUTO	G967	56T17D5385		\$411	F1	2.5	36	12.35	5,18,70
	3600	208-230/460	56HZ	AUTO	B193	56T34D5357	✓	\$488	F1	8.9-8.4/4.2	34	12.22	Z,5,18
	3600	208-230/460	145T	AUTO	K2037	5KE49UN8376T	✓	\$476	E6	8.4-7.6/3.8	34	13.19	d,18,70
	1800	208-230/460	56HZ	AUTO	G145	56T17D5350	✓	\$458	F1	9.2-8.6/4.3	48	14.22	Z,VC,5,18
5	1800	208-230/460	56HZ	AUTO	K1497	5K49WN4335X	✓	\$508	F1	10.2/4.8	44	15.31	11,18
	3600	208-230/460	56HZ	AUTO	X251	56T34D5364	✓	\$654	F1	13.5-12.4/6.2	50	13.49	Z,5,12,17,70
	3600	230/460	145T	AUTO	K2038	5KE49QN8375T	✓	\$541	E6	12.4/6.2	54	14.19	d,17,70

Exhaust Ventilator, Single Phase

Dripproof, C-Face Footless, Single Speed



Features:

- Split phase (except as noted)
- Thermal protection, as noted
- Service Factor, as noted
- Motors with 56CZ frames have 2-1/4 x 5/8 shaft dimensions
- Ball Bearings

HP	RPM	VOLTS	FRAME	OVER LOAD	CAT. NO.	MODEL NO.	STOCK	LIST PRICE	MULT. SYMB.	F.L. AMPS	WEIGHT	"C" DIM.	FOOT NOTES
1/12	1140	115	56CZ	NONE	H204	5KH32GN142	✓	\$247	F1	2.4	13	9.62	112
	850	115	56CZ	NONE	H205	5KH37PN37	✓	\$358	F1	3.2	19	11.08	112
	850	115	56CZ	AUTO	H278	5KH37PN37X	✓	\$367	F1	3.2	19	11.08	112
1/8	1140	115	56CZ	AUTO	H287	5KH36KN112X	✓	\$285	F1	3.8	15	10.68	112
	1140	115	56CZ	NONE	H206	5KH36KN112	✓	\$271	F1	3.8	15	10.68	112
	850	115	56CZ	NONE	H207	5KH46MN3041	✓	\$439	F1	4.6	22	11.15	112
1/6	1725	115	56CZ	NONE	H208	5KH32DN111	✓	\$145	F1	4.2	11	9.62	20
	1140/850	115	56CZ	NONE	H222	5KH49PN3047	✓	\$431	F1	4.2/2.9	43	11.70	20
	1140	115	56CZ	AUTO	H210	5KH37PN36X	✓	\$316	F1	4.0	19	11.08	20
1/4	1140	115	56CZ	NONE	H209	5KH37PN36	✓	\$221	F1	4.0	19	11.08	20
	1725	115	56CZ	NONE	H212	5KH33FN77	✓	\$154	F1	5.6	13	9.87	20
	1725	115	56CZ	AUTO	H213	5KH33FN77X	✓	\$231	F1	5.6	13	9.87	20
	1725/1140	115	56CZ	NONE	H223	5KH37PN40	✓	\$296	F1	4.2/2.7	20	11.08	20
	1140/850	115	56CZ	NONE	H224	5KH49SN3049	✓	\$525	F1	5.8/3.6	29	11.91	20
	1140	115	56CZ	NONE	H214	5KH46MN6071	✓	\$262	F1	5.6	22	11.15	20
	1140	115	56CZ	AUTO	H215	5KH46MN6071X	✓	\$361	F1	5.6	22	11.15	20
1/3	850	115	56CZ	AUTO	H288	5KH49SN3023X	✓	\$617	F1	6.9	31	13.59	20
	1725	115	56CZ	NONE	H217	5KH35JN121	✓	\$174	F1	6.6	14	10.25	20
	1725	115	56CZ	AUTO	H218	5KH35JN121X	✓	\$261	F1	6.6	14	10.25	20
	1725/1140	115	56CZ	NONE	H225	5KH46MN3040	✓	\$368	F1	5.7/3.2	22	11.15	20
	1140	115	56CZ	NONE	H219	5KH49PN6069	✓	\$432	F1	7.0	31	11.70	20
1/2	850	115	56CZ	AUTO	H280	5KH49UN3024X	✓	\$647	F1	9.2	40	13.59	20
	1725	115	56CZ	NONE	H290	5KH36MN137	✓	\$230	F1	7.2	16	11.31	19
	1725/1140	115	56CZ	AUTO	H282	5KH49PN3042X	✓	\$444	F1	8.0/4.2	31	11.70	19
	1725/1140	115	56CZ	NONE	H226	5KH49PN3042	✓	\$432	F1	8.0/4.2	26	11.70	19
	1140	115	56CZ	NONE	H221	5KH48UN6074	✓	\$490	F1	9.0	34	12.66	19
1140	115/208-230	56C	NONE	G278	56C11D5304	✓	\$448	F1	10.6/5.1-5.3	32	11.94	2,19	

Furnace Blower, Split Phase

Open, PDQ Mounting

Applications:

Designed for replacement of virtually any NEMA 48 and 56 frame belt drive furnace blower motors. PDQ models have 1 1/2" extended splined hub on opposite shaft end for quick and easy positioning of resilient ring to properly fit the pre-existing motor base.



Features:

- Ball bearings
- Reversible rotation connected for CCW rotation from factory
- NEMA service factors
- 4733, 4734 and 4735 have both 48 and 56 frame mounting holes and includes mounting base
- UL Recognized and CSA Certified

HP	RPM	VOLTS	FRAME	OVER LOAD	CAT. NO.	MODEL NO.	STOCK	LIST PRICE	MULT. SYMB.	F.L. AMPS	WEIGHT	"C" DIM.	MIN/MAX BASE DIM'S	FOOT NOTES
1/4	1725	115	48Y	AUTO	4733	5KH39DNA533T	✓	\$159	F1	5.1	13	9.78	6.62" & 7.91"	
	1725	115	48Y	AUTO	4730	5KH39QN9725T	✓	\$146	F1	5.0	13	9.78	6.62" & 7.91"	30
1/3	1725	115	48Y	AUTO	4734	5KH32HNA532T	✓	\$171	F1	6.6	15	10.03	6.87" & 8.16"	
	1725	115	48Y	AUTO	4731	5KH39QN9696X	✓	\$157	F1	5.8	15	10.28	7.12" & 8.41"	30
	1725	230	48Y	AUTO	4738	5KH39QN9703T	✓	\$256	F1	3.1	15	10.28	7.12" & 8.41"	30
1/2	1725	115	48Y	AUTO	4732	5KH39QN9702T	✓	\$207	F1	7.9	17	10.66	7.50" & 8.79"	30
	1725	115	48Y	AUTO	4735	5KH33JNA534T	✓	\$224	F1	7.9	15	10.28	6.62" & 7.91"	
	1725	230	48Y	AUTO	4739	5KH39QN9704T	✓	\$323	F1	4.0	17	10.66	7.50" & 8.79"	30

Oil Burner, Split Phase and Capacitor Start NEMA 48M and 48N Flange Mount

Applications:

Direct replacement motors for residential and commercial oil burners and hot water pre

Features:

- Ball Bearings (except as noted)
- Semi- or totally enclosed steel frame
- 20" Long leads from a 1/2" NPT opening (totally enclosed footnoted with N)
- Split phase and capacitor start designs
- Two-bolt, NEMA N- or M-Flange direct
- Catalog numbers 4781, 4788, O010 mounting and O011 have dripproof enclosures
- 1.0 Service Factor



HP	RPM	VOLTS	FRAME	OVER LOAD	CAT. NO.	MODEL NO.	STOCK	LIST PRICE	MULT. SYMB.	F.L. AMPS	WEIGHT	"C" DIM.	FOOT NOTES
1/8	3450	115	48N	MANUAL	O005	48S34S2004	√	\$128	F1	2.4	9	7.09	3,61
	1725	115	48N	MANUAL	O600	48S17T286	√	\$112	F1	2.8	11	7.7	CF,N,3
1/7	3450	115	48M	MANUAL	O100	48S34S361	√	\$138	F1	2.8	11	7.7	CF,3
	1/6	3450	115	48M	MANUAL	O102	48S34S2005	√	\$146	F1	3.0	11	7.25
	1725	115	48N	MANUAL	O601	48S17T290	√	\$120	F1	2.7	12	7.59	CF,N,3
	1/5	3450	115/230	48N	MANUAL	O012	48C34S24	√	\$170	F1	3.0/1.5	14	8.35
1/4	3450	115	48N	MANUAL	4785	5KH32EN5015U	√	\$161	F1	4.1	13	8.13	d,3,4
	3450	115	48N	MANUAL	O004	48S34S2003	√	\$170	F1	4.2	13	8.13	CF,3
	3450	115/230	48N	MANUAL	O013	48C34S2001		\$177	F1	4.4/2.2	19	8.6	2
	1725	115	48N	MANUAL	O002	48S17S25	√	\$145	F1	4.2	12	7.59	3
1/3	3450	115/230	48N	MANUAL	4788	5KC37EN3900U	√	\$186	F1	6.0/3.0	14	10.13	d
	3450	115/208-230	48N	MANUAL	O010	48C34D2024	√	\$186	F1	5.6/2.7-2.8	14	10.34	2
	3450	115	48N	MANUAL	4774	5KH33GN5014U	√	\$173	F1	4.9	15	8.38	3,4
	1725	115	48N	MANUAL	O003	48S17S24	√	\$168	F1	5.0	17	8.34	3
1/2	3450	115/230	48N	MANUAL	4781	5KC37HN3898U		\$229	F1	8.2/4.1	15	10.13	
	3450	115/208-230	48N	MANUAL	O011	48C34D2028	√	\$229	F1	7.4/3.5-3.7	17	10.84	2
	1725/1140	115	56CZ	AUTO	H282	5KH49PN3042X	√	\$444	F1	8.0/4.2	31	11.70	19
	1725/1140	115	56CZ	NONE	H226	5KH49PN3042	√	\$432	F1	8.0/4.2	26	11.70	19
	1140	115	56CZ	NONE	H221	5KH48UN6074	√	\$490	F1	9.0	34	12.66	19
	1140	115/208-230	56C	NONE	G278	56C11D5304	√	\$448	F1	10.6/5.1-5.3	32	11.94	2,19

Oil Burner, PSC NEMA 48M Flange Mount

Applications:

Replacement motors for mini pumps in residential or light commercial furnaces.

Features:

- High efficiency design
- 14" cord for easy connection
- Ultra quiet performance
- UL Recognized and CSA Certified



HP	RPM	VOLTS	FRAME	OVER LOAD	CAT. NO.	MODEL NO.	STOCK	LIST PRICE	MULT. SYMB.	F.L. AMPS	WEIGHT	"C" DIM.	FOOT NOTES
1/7	3450	115	48M	AUTO	4777	5KCP100EZA001X	√	\$119	F1	1.7	8	6.61	d,3,4
	3450	115	48M	AUTO	O701	48A34SU1001	√	\$119	F1	1.7	8	6.61	3,61

Oil Burner, Split Phase and Capacitor Start Dripproof, NEMA 56C, C-Face Footless

Features:

- Ball Bearings
- Manual or automatic reset thermal
- Split Phase and capacitor start designs protector
- NEMA 56C direct mounting
- NEMA Jet Pump Service Factors
- Moderate starting torque
- UL Recognized and CSA Certified



HP	RPM	VOLTS	FRAME	OVER LOAD	CAT. NO.	MODEL NO.	STOCK	LIST PRICE	MULT. SYMB.	F.L. AMPS	WEIGHT	"C" DIM.	FOOT NOTES
1/4	3600	115	56C	MAN	O200	56S34D2000	✓	\$139	F1	4.3	14	10.19	3,15,115
1/3	3600	115	56C	AUTO	O201	56S34D93	✓	\$132	F1	5.6	14	10.44	2,3,15
	3600	115/230	56C	AUTO	J1025	5KC37FN71X	✓	\$154	F1	6.4/3.2	14	10.71	2,115
	3600	115/208-230	56C	MAN	O211	56C34D2109	✓	\$161	F1	5.6/2.7-2.8	14	10.44	2,115
	3600	115/208-230	56C	AUTO	O210	56C34D2114	✓	\$154	F1	5.6/2.7-2.8	14	10.44	2,115
1/2	3600	115/208-230	56C	MAN	O213	56C34D2099	✓	\$176	F1	7.4/3.5-3.7	16	10.69	2,114
	3600	115/208-230	56C	AUTO	O212	56C34D2098	✓	\$169	F1	7.4/3.5-3.7	17	10.69	2,114
	3600	115/230	56C	AUTO	C330	5KC36JN268X	✓	\$205	F1	7.6/3.8	17	10.31	2,114
3/4	3600	115/208-230	56C	MAN	O215	56C34D2112	✓	\$199	F1	9.8/4.8-4.9	18	10.94	2,113
	3600	115/208-230	56C	AUTO	O214	56C34D2104	✓	\$199	F1	9.8/4.8-4.9	20	10.94	2,113
	3600	115/230	56C	AUTO	C332	5KC39NN50X	✓	\$199	F1	11.2/5.6	22	11.84	2,113
1	3600	115/230	56C	AUTO	C334	5KC39RN44X	✓	\$223	F1	13.2/6.6	22	12.59	2,112
	3600	115/208-230	56C	MAN	O217	56C34D2105	✓	\$230	F1	12.0/6.2-6.0	24	11.94	2,112
1 1/2	3600	115/208-230	56C	MAN	O231	56B34D2028	✓	\$312	F1	13.4/7.4-6.7	25	11.97	1,111
	3600	115/208-230	56C	AUTO	C336	5KC49NN2140X	✓	\$304	F1	18.4-9.8/9.2	27	11.38	1,111
2	3600	115/208-230	56C	AUTO	C338	5KC49TN2141X	✓	\$377	F1	21.2-11.5/10.6	38	13.22	1,110
	3600	115/208-230	56C	MAN	O232	56B34D5337	✓	\$386	F1	19.2/10.3-9.6	33	11.44	1,110
3	3600	115/230	56C	AUTO	C340	5KCR48TN2142T	✓	\$599	F1	29.4/14.7	38	12.66	1,18

Oil Burner, Three Phase Dripproof, NEMA 56C, C-Face Footless

Features:

- Double sealed ball bearings
- NEMA Jet Pump Service Factors
- NEMA 56C direct mounting
- Ball Bearings
- UL Recognized and CSA Certified

HP	RPM	VOLTS	FRAME	OVER LOAD	CAT. NO.	MODEL NO.	STOCK	LIST PRICE	MULT. SYMB.	F.L. AMPS	WEIGHT	"C" DIM.	FOOT NOTES
1/3	3600	208-230/460	56C	NONE	KG215	5K35FN55	✓	\$177	F1	1.5-1.8/0.9	14	9.88	68,115
1/2	3600	208-230/460	56C	NONE	K216	5K36JN57	✓	\$202	F1	2.0-2.0/1.0	15	10.31	68,114
3/4	3600	208-230/460	56C	NONE	K218	5K37MN37	✓	\$243	F1	2.6-2.6/1.3	17	10.7	68,113
1	3600	208-230/460	56C	NONE	K220	5K38PN47	✓	\$276	F1	3.3-3.2/1.6	20	11.3	68,112
1 1/2	3600	208-230/460	56C	NONE	K222	5K46KN2173	✓	\$336	F1	5.0-4.8/2.4	24	10.73	68,111
2	3600	208-230/460	56C	NONE	K224	5K49NN2180	✓	\$395	F1	6.0-6.0/3.0	27	11.33	68,110
3	3600	208-230/460	56C	NONE	K226	5K48TN2182	✓	\$473	F1	8.9-8.2/4.1	36	12.61	68,18

Refrigeration Fan, PSC, Open Air Over Resilient Ring & Thru-Bolt Mount

Features:

- Open end bracket
- Ball Bearings
- Automatic reset thermal protector
- BX connector included in frame (except on Catalog # X262)
- Catalog # X263 and X264 have 12" cord and molded plug
- UL Recognized and CSA Certified
- **Capacitor included (except on Catalog # X262 and X426)**



HP	RPM	VOLTS	FRAME	CAT. NO.	MODEL NO.	STOCK	LIST PRICE	MULT. SYMB.	F.L. AMPS	WEIGHT	FRAME LENGTH	"C" DIM.	FOOT NOTES
1/6	1625	208-230	48Y	X269	48A17O147	✓	\$201	F1	1.2	11	5.00	1/2 x 1 1/2	1
1/4	1625	208-230	48Y	X270	48A17O149	✓	\$216	F1	1.9	12	5.69	1/2 x 2 1/2	1
	1075	208-230	48Y	X263	48A11O11041		\$173	F1	2.0	13	4.25	1/2 X 3 3/4	16
	1075	208-230	48Y	X262	48A11D245	✓	\$182	F1	1.8	15	7.25	1/2 x 1 5/8	67,69,82
1/3	1625	208-230	48YZ	X230	48A17O136	✓	\$181	F1	1.8	14	5.69	1/2 x 3 1/2	15
	1075	208-230	48YZ	X268	48A11O1239	✓	\$221	F1	3.0	14	5.69	1/2 x 2 1/2	15
3/4	1075	460	48YZ	X426	48A11O1375	✓	\$270	F1	2.2	19	6.38	5/8 X 4 1/2 w/key	67,69

Refrigeration Fan Motors, Three Phase Open Air Over, Shaft Up & Horizontal Rigid Base Mount

Applications:

Replacement motor for refrigeration equipment.

Features:

- **70°C ambient**
- Enclosed shaft end bracket, vented frame
- Continuous duty
- Automatic reset thermal protector
- Shaft slinger
- Threaded lead exit
- Nameplated 60/50 hertz 190/380 volts, at next lower HP
- Double sealed ball bearings
- Flat and keyway on shaft
- Patented VCD, Voltage Change Device
- Ball Bearings
- UL Recognized and CSA Certified

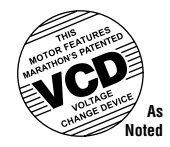

HP	RPM	VOLTS	FRAME	CAT. NO.	MODEL NO.	STOCK	LIST PRICE	MULT. SYMB.	F.L. AMPS	WEIGHT	FRAME LENGTH	"C" DIM.	FOOT NOTES
1/2	850	208-230/460	56HZ	X529	56T8O5531	✓	\$547	F1	2.9-3.0/1.5	31	9.62	5/8 x 5	VC,5
1	850	208-230/460	56HZ	X528	56T8O5306	✓	\$614	F1	5.1-5.3/2.65	49	10.62	5/8 x 5	VC,5
	850	208-230/460	56Y	X507	56T8O5302	✓	\$597	F1	5.3-5.3/2.6	46	12.00	5/8 x 5	VC
	850	575	56Y	K1511	5K48WN3181S	✓	\$563	F1	2.0	44	10.77	5/8 X 6	
1 1/2	1140	208-230/460	56HZ	X523	56T11O5306	✓	\$501	F1	5.45-5.4/2.7	36	11.00	5/8 x 5	VC,5
	850	208-230/460	56HZ	X531	56T8O15504	✓	\$668	F1	7.0-7.0/3.5	47	11.50	5/8 x 5	VC,5
2	1140	208-230/460	56HZ	X525	56T11O5310	✓	\$543	F1	7.2-6.8/3.4	47	12.00	5/8 x 5	VC,54

Transformer Cooling Fan Replacement

TEAO, Single Speed, Rigid Base

Features:

- External cooling air required
- Reversible rotation
- Ball Bearings
- Optional extended clamp screws
- Z shaft is .50 x 2.25" with 1.91" Flat



Single Phase

HP	RPM	VOLTS	FRAME	CAT. NO.	MODEL NO.	STOCK	LIST PRICE	MULT. SYMB.	F.L. AMPS	WEIGHT	"C" DIM.	FOOT NOTES
1/20	1625	115/200-230	48Z	PG240	5KCP35CNA490S	√	\$327	F1	1.5/07-0.8	12	10.32	9,25,50,94,113

Three Phase

HP	RPM	VOLTS	FRAME	CAT. NO.	MODEL NO.	STOCK	LIST PRICE	MULT. SYMB.	F.L. AMPS	WEIGHT	"C" DIM.	FOOT NOTES
1/3	1200	200-230/460	56	K1487	5K49MN6126T	√	\$579	F1	2.1-2.0/1.0	27	10.38	68,113

Unit Heater Fan, PSC, TEAO

Resilient Base

Applications:

Replacement motors for unit heaters. Air over motors need to be mounted within the airstream for proper cooling.



Features:

- Totally enclosed
- Direct drive, air over
- Ball Bearings
- Horizontal or vertical mount
- Weather resistant reversing plug
- BX connector mounted in frame
- 1" Extended thru-bolts
- 48Y Frame has non-standard BA dimension
- Automatic reset thermal protection
- UL Recognized and CSA Certified
- Capacitor included

HP	RPM	VOLTS	FRAME	CAT. NO.	MODEL NO.	STOCK	LIST PRICE	MULT. SYMB.	F.L. AMPS	WEIGHT	FRAME LENGTH	"C" DIM.	FOOT NOTES
1/6	1625	115	48Y	X305	48A17T2001	√	\$164	F1	2.0	13	4 3/4	1/2 x 2 3/4	
	1625	115	48Y	X301	48A17T72	√	\$146	F1	2.0	13	5 1/4	1/2 x 2 3/4	
	1075	115	48Y	X302	48A11T199	√	\$170	F1	3.0	13	4 3/4	1/2 x 2 3/4	
1/4	1075	115	48Y	X303	48A11T198	√	\$178	F1	4.1	14	4 3/4	1/2 x 2 3/4	
1/3	1075	115	48Y	X304	48A11T201	√	\$197	F1	6.5	21	21	1/2 x 2 3/4	

Circulator Pump, Split Phase

Dripproof, Resilient Ring

Applications:

Direct replacements for Taco hot water circulators.

Features:

- Quiet sleeve bearing construction
- 48Z frame with 1/2" diameter shaft, 1" long without flat
- 1.40 Service Factor (except as noted)
- Fixed CCW rotation, viewed opposite shaft end
- 4722 replaces Taco No. 110-388, Marathon No. 48S17D1027, 48S17D2102
- 4404 replaces GE No. 5KH32EG129GA, Marathon No. 48S17D1084
- UL Recognized and CSA Certified



HP	RPM	VOLTS	FRAME	CAT. NO.	MODEL NO.	STOCK	LIST PRICE	MULT. SYMB.	F.L. AMPS	WEIGHT	"C" DIM.	FOOT NOTES
1/12	1800	115	48Y	4722	5KH39QN5558T	√	\$116	F1	2.1	12	7.29	
1/8	1800	115	48Y	4404	5KH39QN5550X	√	\$126	F1	2.6	11	8.93	
1/4	1800	115	48Y	HG716	5KH36DNA780X	√	\$277	F1	5.7	12	9.01	4,17
1/3	1800	115	48Y	HG717	5KH37GNA782X	√	\$296	F1	6.2	14	9.41	4,17



ME-CAN-DO Multi-Horsepower Motors

The new Marathon Electric "Me-Can-Do" line of motors is a Multi-horsepower motor that replaces many different ratings.

Here are some of the advantages of the ME-Can-Do motor:

1. Saves money! Eliminates unnecessary inventory on shelves or in repair trucks.
2. Saves time! No more long drives for replacement motors. No more late hour or emergency shop openings.
3. This motor "Can Do" the job the first time! Offers multiple options in just one motor, no need for temporary substitutions.

Here are some of the motors that the ME-Can-Do motors replaces today:

Condenser Fan Motors

MARATHON	EMERSON	A.O. SMITH
X072	5462	FSE6000
X076	5465	FE6002

Direct Drive Fan and Blower Motors

MARATHON	EMERSON	A.O. SMITH
X033	5460	FDL6001
X073	5461	FD6000
X074	5470	FDL6002
X075	5471	FD6001

ME-CAN-DO Multi-Horsepower Condenser Fan, PSC, TEAO, Thru-Bolt

Applications:

Direct drive fans for shaft up or horizontal mount. These motors need to be mounted within the airflow of the fan for proper cooling.

Features:

- Ball Bearings
- 60°C ambient
- Automatic reset thermal protector
- Weather resistant reversing plug
- Reversible by reconnection
- 36" long leads
- Extended thru-bolts, 8-32 1/2" on drive end, 3/4" on non-drive end
- Shaft slinger
- Four Locating screws on frame, 90° apart
- 1/2" x 5" long shaft with two flats 4.50" 90° apart
- UL Recognized and CSA Certified
- Capacitor not included, see Accessories section



HP	RPM	VOLTS	FRAME	CAPACITOR (MFD)	SPEED RANGE	CAT. NO.	MODEL NO.	STOCK	LIST PRICE	MULT. SYMB.	WEIGHT	F.L. AMPS	FRAME LENGTH
1/3		230		5.0	HI							2.3	
1/3		208		7.5	HI							2.3	
1/4		230		5.0	HI							2.0	
1/4	1075/2	208	48Y	7.5	HI	X072	48A11T646	√	\$191	F1	14	2.0	5 1/2
1/5		230		5.0	LO							1.4	
1/5		208		7.5	LO							1.4	
1/6		230		5.0	LO							1.2	
1/6		208		7.5	LO							1.2	
1/2		230		10.0	HI							2.5	
1/2		208		12.5	HI							2.6	
1/3		230		10.0	HI							2.1	
1/3	1075/2	208	48Y	12.5	HI	X076	48A11T11006	√	\$205	F1	19	2.0	5 1/2
1/4		230		10.0	LO							1.4	
1/4		208		12.5	LO							1.4	
1/5		230		10.0	LO							1.2	
1/5		208		12.5	LO							1.2	

ME-CAN-DO Multi-Horsepower Fan & Blower - Direct Drive, PSC, Open Air Over Resilient Ring, Thru-Bolt

Applications:

Residential and commercial furnaces, air conditioners, exhaust fans, and other air handling equipment installed in clean and dry environments.

Features:

- Open end brackets
- 2 1/4" Resilient rings
- 1/2" x 5" long shaft with two flats 4.50" 900 apart
- Automatic reset thermal protector
- Weather resistant reversing plug
- Reversible by reconnection
- 36" long leads
- Extended thru-bolts, 8-32 1/2" on drive end, 3/4" on non-drive end
- UL Recognized and CSA Certified
- Capacitor not included, see Accessories section
- Ball Bearings



HP	RPM	VOLTS	FRAME	CAPACITOR (MFD)	SPEED RANGE	CAT. NO.	MODEL NO.	STOCK	LIST PRICE	MULT. SYMB.	WEIGHT	F.L. AMPS	FRAME LENGTH
1/2				10.0	ALL							6.1	
1/3				5.0	ALL							5.2	
1/3				7.5	ALL							4.7	
1/4				5.0	MED-HI							3.6	
1/4	1075/4	115	48Y	7.5	MED-LO, LO	X077	48A11011066	✓	\$145	F1	15	3.2	5
1/5				5.0	MED-LO							2.8	
1/5				7.5	LO							2.5	
1/6				5.0	LO							2.4	
1/6				7.5	LO							2.0	
1/2				10.0	ALL							2.7	
1/3				5.0	ALL							2.3	
1/3				7.5	ALL							2.1	
1/4				5.0	MED-HI							1.6	
1/4	1075/4	208-230	48Y	7.5	MED-LO, LO	X073	48A11011064	✓	\$149	F1	14	1.4	4 3/4
1/5				5.0	MED-LO							1.3	
1/5				7.5	LO							1.1	
1/6				5.0	LO							1.1	
1/6				7.5	LO							0.9	
3/4				20.0	ALL							7.8	
1/2				10.0	ALL							7.1	
1/3	1075/4	115	48Y	10.0	MED-HI, MED-LO, LO	X074	48A11011042	✓	\$173	F1	22	4.9	6
1/4				10.0	MED-LO, LO							3.7	
1/5				10.0	LO							2.9	
3/4				20.0	HI							3.8	
1/2				20.0	MED-HI							2.7	
1/2				10.0	HI							3.7	
1/3	1075/4	208-230	48Y	20.0	MED-LO	X075	48A11011063	✓	\$185	F1	22	1.9	6
1/3				10.0	MED-HI							2.8	
1/4				20.0	LO							1.4	
1/4				10.0	MED-LO							2.6	
1/5				10.0	LO							1.6	

OEM: Carrier PSC, Open Air Over

Features:

- Ball Bearings
- Multi-speed capability, as noted
- Resilient ring/belly band mount
- X236 Replaces Carrier Nos. HC41SE117, P251-2306 & -2307
- X237 Replaces Carrier Nos. HC41SE651, HC39SE651, P251-5306, & P251-5408
- X203 Replaces Carrier No. HC44AL230, Fasco No. D804, & Magnetek No. 655
- X241 Replaces Carrier Nos. HC45SE651 & P251-5701
- X242 Replaces Carrier Nos. HC52AL230, 231, & 232 HC52SE208, P251-5101 & -5102
- Capacitor not included, see Accessories section

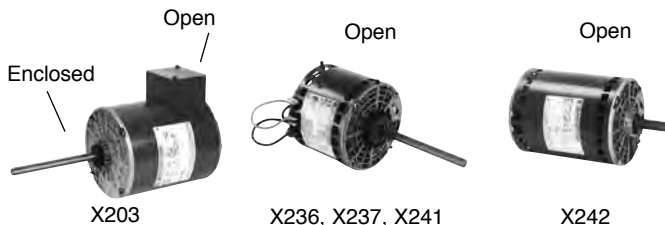

HP	RPM	VOLTS	FRAME	CAT. NO.	MODEL NO.	STOCK	LIST PRICE	MULT. SYMB.	F.L. AMPS	WEIGHT	FRAME LENGTH	SHAFT DIM.	FOOT NOTES
1/3	1075/4	115	48Y	X236	48A11O699	✓	\$173	F1	6.4	16	4 3/4	1/2x6	
	1075/4	208-230	48Y	X237	48A11O694		\$176	F1	4.8	16	5 1/4	1/2x6	
1/2	1075	208-230	48Y	X203	48A11O1062	✓	\$216	F1	5.3	19	6 1/2	1/2 x 5 1/2	16
3/4	1075/4	208-230	48Y	X241	48A11O697	✓	\$223	F1	5.4	17	5 1/2	1/2x6	
1	1000/3	208-230	48YZ	X242	48A11O756	✓	\$377	F1	6.2	26	7 1/4	5/8x4	51,68

Replacements listed may not be an exact duplicate of the original motor

OEM: Carrier PSC, Open Air Over

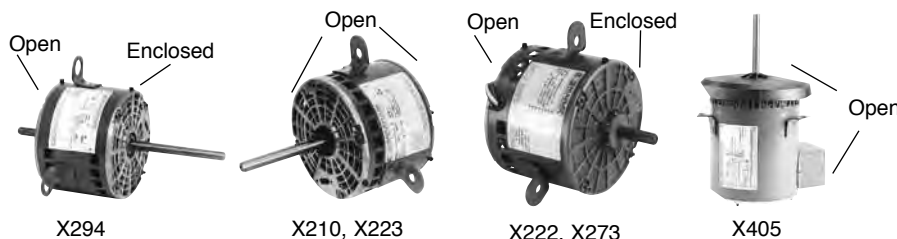

Features:

- Single and multi-speed models, as noted
- 3 lug mounting
- X223 Replaces Carrier No. HC37VE230 & Fasco No. D842
- X273 Replaces Carrier No. HC37ME268, Fasco No. D844, A.O. Smith No. OCA1024, & Magnetek No. 624
- X210 Replaces Carrier Nos. HC37MZ220, HC39VE608, HC39ML706, HC37ME720, HC37ML702
- X210 Replaces Emerson No. 3303, Fasco No. D843, Magnetek No. 514, & A.O. Smith No. OCB1026
- X222 Replaces Carrier Nos. HC41VE700 & 701, Emerson No. 3225, Magnetek No. 536, & A.O. Smith No. OCB1036
- X294 Replaces Carrier No. HC43CE230
- X405 Replaces A.O. Smith No. OCA1056
- Ball bearings (except as noted)
- Capacitor not included, see Accessories section



HP	RPM	VOLTS	FRAME	CAT. NO.	MODEL NO.	STOCK	LIST PRICE	MULT. SYMB.	F.L. AMPS	WEIGHT	FRAME LENGTH	SHAFT DIM.	FOOT NOTES
1/5	1075/1	230	48Y	X223	48A11O2050		\$146	F1	1.3	10	3 3/4	1/2 x 2 3/4	16
1/4	1625/1	230	48Y	X273	48A17O161		\$137	F1	1.5	12	4 1/4	1/2 x 1 5/8	16
	1075/2	208-230	48Y	X210	48A11O1068	✓	\$146	F1	2.2	13	4 1/8	1/2 x 4 1/4	
1/3	1075/2	230	48Y	X222	48A11O1109	✓	\$182	F1	2.6	15	4 3/4	1/2 x 3	
1/2	1075/1	208-230/460	48Y	X405	48A11O1744	✓	\$237	F1	3.6/1.8	25	6 7/8	1/2 x 4	21

OEM: Carrier

Three Phase, Open Air Over

Features:

- Ball Bearings
- X235 is 70°C ambient
- Ball Bearings
- X235 replaces Carrier No. HD52VE214 & Marathon No. 56T11D33
- X251 replaces Carrier No. HD60AZ660 & Marathon No. 56T34D903



X235



X251

HP	RPM	VOLTS	FRAME	CAT. NO.	MODEL NO.	STOCK	LIST PRICE	MULT. SYMB.	F.L. AMPS	WEIGHT	FRAME LENGTH	SHAFT DIM.	FOOT NOTES
1	1140	200-230/460	56Y	X235	56T11D5209	✓	\$469	F1	6.6-6.0/3.0	36	10 1/2	5/8 x 2 7/8	
5	3600	208-230/460	56HZ	X251	56T34D5364	✓	\$654	F1	13.5-12.4/6.2	50	13.49	7/8 x 2 1/4	Z,5

Replacements listed may not be an exact duplicate of the original motor

OEM: Evans/Armstrong/LSI Home

PSC, Open Air Over

Features:

- Resilient ring thru-bolt mounting
- Replaces Fasco No. D825 & GE No. 5KCP35G644S
- Ball bearings
- Capacitor not included, see Accessories section

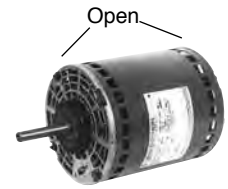

HP	RPM	VOLTS	FRAME	CAT. NO.	MODEL NO.	STOCK	LIST PRICE	MULT. SYMB.	F.L. AMPS	WEIGHT	FRAME LENGTH	FOOT NOTES
1	1625/2	208-230	48Y	X211	48A17O125	✓	\$248	F1	6.2	20	6 1/4	1/2 x 2 1/2

OEM: Greenheck Fan

PSC, Open Air Over

Features:

- Thru-bolt mounting
- Automatic reset thermal protector
- Internal cooling fan
- X261 replaces Greenheck No. 300008
- X260 replaces Greenheck No. 300010
- Ball bearings
- Capacitor included



HP	RPM	VOLTS	FRAME	CAT. NO.	MODEL NO.	STOCK	LIST PRICE	MULT. SYMB.	F.L. AMPS	WEIGHT	FRAME LENGTH	FOOT NOTES
1/8	825	115	48Y	X261	48A8O151	✓	\$195	F1	2.1	13	5 1/2	1/2 X 2 1/2
1/6	1140	115	48Y	X260	48A11O251	✓	\$185	F1	2.2	13	5 1/4	1/2 X 2 1/2

Replacements listed may not be an exact duplicate of the original motor

OEM: Hill Refrigeration

PSC, Open Air Over

Features:

- Resilient base
- Replaces Magnetek No. 160, Stevec Co. S3001, Fasco No., D801, GE No. 5KCP39KG1369S
- Ball bearings
- Capacitor included

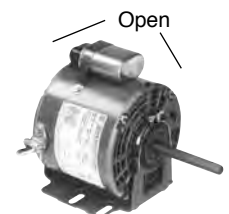

HP	RPM	VOLTS	FRAME	CAT. NO.	MODEL NO.	STOCK	LIST PRICE	MULT. SYMB.	F.L. AMPS	WEIGHT	FRAME LENGTH	SHAFT DIM.	FOOT NOTES
1/3	1625	208-230	48Y	X230	48A17O136	✓	\$181	F1	1.8	14	4 3/4	1/2x3 1/2	15

OEM: Huebsch

Single Phase, Dripproof, Resilient Base



Applications:

Commercial laundry dryer motors.

Features:

- Replaces Huebsch commercial laundry dryer motors
- Automatic reset thermal protection
- Special threaded shaft extension
- X602 has 3/4" shaft adapter included
- Ball bearings
- 48YZ have 48/56 Fr. mounting holes

HP	RPM	VOLTS	FRAME	CAT. NO.	MODEL NO.	STOCK	LIST PRICE	MULT. SYMB.	F.L. AMPS	WEIGHT	"C" DIM.	FOOT NOTES
1/4	1725	100-120/200-240	48YZ	X600	48C17D2057		\$239	F1	5.4-6.6/2.7-3.3	18	12.02	16,68
1/3	1725	115/208-230	56Z	X601	56C17D2101	✓	\$283	F1	5.8/2.8-2.9	20	14.41	16
1/2	1725	115/208-230	56Z	X602	56C17D2102	✓	\$348	F1	8.0/4.0-4.0	24	15.41	16
3/4	1725	115/208-230	56Z	X603	56C17D5346	✓	\$439	F1	12.0/5.8-6.0	29	15.10	16

OEM: Hussman Refrigeration

PSC, Open Air Over

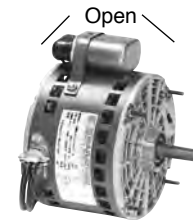

Features:

- Thru-bolt mounting
- Replaces Fasco No. D807, GE No. 5KCP39EGC2447, Magnetek No. 174, Emerson No. 1645
- Ball bearings
- Capacitor included

HP	RPM	VOLTS	FRAME	CAT. NO.	MODEL NO.	STOCK	LIST PRICE	MULT. SYMB.	F.L. AMPS	WEIGHT	FRAME LENGTH	SHAFT DIM.	FOOT NOTES
1/6	1625	208-230	48Y	X269	48A17O147	✓	\$201	F1	1.2	11	4 1/8	1/2 x 1 1/2	15

OEM: Liebert

Three Phase, Resilient Base

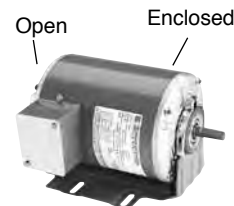

Features:

- Replaces GE 5K36PN294S
- Ball bearings

HP	RPM	VOLTS	FRAME	CAT. NO.	MODEL NO.	STOCK	LIST PRICE	MULT. SYMB.	F.L. AMPS	WEIGHT	FRAME LENGTH	SHAFT DIM.	FOOT NOTES
1/3	1140	208-230/460	48Y	X259	56T11O15	✓	\$249	F1	1.9-1.8/9	29	10.06	1/2x1 1/2	15

Replacements listed may not be an exact duplicate of the original motor

OEM: Lennox

PSC, Totally Enclosed & Open Air Over

Features:

- X411 replaces Lennox No. 47F9901, Magnetek No. 9402, & Marathon Nos. 48A11T300 & 48A11T247
- X209 replaces Fasco No. D2817 & GE No. 5KCP39PG9701S, open/air over
- X236 replaces Lennox No. P-8-7505, Magnetek No. 565, A.O. Smith No. OLE1036, & Fasco No. D812, open/air over
- X281 replaces Lennox No. P-8-2702, Fasco No. D814, GE No. 5KCP39GGA124S, & Emerson No. 8054, open/air over
- Ball Bearings
- Capacitor not included, see Accessories section

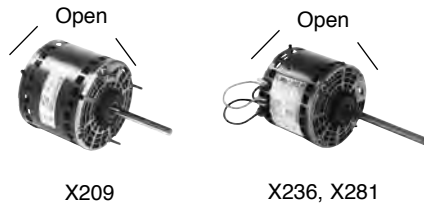
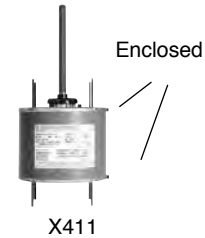

HP	RPM	VOLTS	FRAME	CAT. NO.	MODEL NO.	STOCK	LIST PRICE	MULT. SYMB.	F.L. AMPS	WEIGHT	FRAME LENGTH	SHAFT DIM.	FOOT NOTES
1/6	1075/1	208-230	48Y	X411	48A11T2008	✓	\$152	F1	1.3	10	3 3/4	1/2 x 6	
1/3	825/1	230	48Y	X209	48A8O183	✓	\$190	F1	3.0	17	5 3/4	1/2 x 5 1/2	34,50
	1075/4	115	48Y	X236	48A11O699	✓	\$173	F1	6.4	16	4 3/4	1/2 x 6	39

OEM: Rheem / Ruud

PSC, Totally Enclosed & Open Air Over

Features:

- X278 Replaces Rheem Nos. 21276-02, 21276-01, 51207-01& Fasco No. D832
- X216 Replaces Emerson No. 5454 & Magnetek No. 619
- X470 Replaces Rheem / Ruud condenser fans
- X297 Replaces A.O. Smith No. ORM1036, Magnetek 620, & Fasco No. D2834
- X033 Replaces Rheem Time-Savers, Emerson No. K55HXMDA-4122, & Rheem / Ruud No. 51-23012-41
- Ball Bearings
- Capacitor not included, see Accessories section

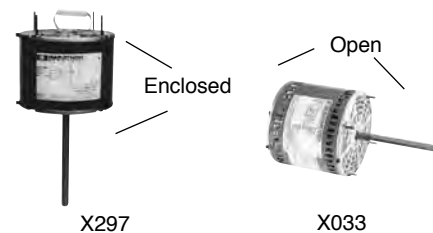
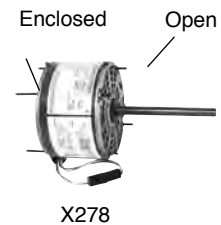

HP	RPM	VOLTS	FRAME	CAT. NO.	MODEL NO.	STOCK	LIST PRICE	MULT. SYMB.	F.L. AMPS	WEIGHT	FRAME LENGTH	SHAFT DIM.	FOOT NOTES
1/8	825/1	208-230	48Y	X278	48A8O206	✓	\$181	F1	.9	11	4 1/4	1/2 x 4 3/4	37,44
1/5	1075/1	208-230	48Y	X216	48A11O1097	✓	\$133	F1	1.6	10	3 3/4	1/2 x 6	37,44,60
1/4	1075/1	208-230	48Y	X470	48A11O885	✓	\$140	F1	1.6	9	3 3/4	1/2 x 3	56,60
1/3	1075/1	208-230	48Y	X297	48A11T509	✓	\$141	F1	1.8	12	4 1/4	1/2 x 3 3/4	N,29,41,60
1/2	1075/4	115	48Y	X033	48A11O1674	✓	\$145	F1	6.1	16	5	1/2 x 5	31

Replacements listed may not be an exact duplicate of the original motor

OEM: Sears/Whirlpool

PSC, Open Air Over

Features:

- X215 replaces Delco inside out window a/c, Fasco No. D857, A.O. Smith No.OWL1006, & Emerson No. 1142
- X212 replaces Delco inside out window a/c, Fasco No. D858, & A.O. Smith No. OWR1016
- X200 replaces Delco inside out window a/c, Fasco No. D859, Emerson No. 855, & A.O. Smith No. OWR1036
- X218 replaces Steveco Package unit 3100
- Single Split Phase, Open Air Over
- Capacitor not included, see Accessories section

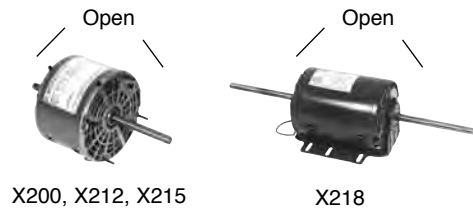

OEM REPLACEMENTS

HP	RPM	VOLTS	FRAME	CAT. NO.	MODEL NO.	STOCK	LIST PRICE	MULT. SYMB.	F.L. AMPS	WEIGHT	FRAME LENGTH	SHAFT DIM.	FOOT NOTES
1/8	1100/3	115	48Y	X215	48A11O1081		\$145	F1	1.7	10	3 7/8	4 x 1/2 x 2 3/4	4,16
1/6	1100/3	230	48Y	X212	48A11O1065		\$145	F1	1.1	11	3 7/8	4 x 1/2 x 2 3/4	16
1/3	1100/3	230	48Y	X200	48A11O1060		\$147	F1	1.7	12	4 1/3	6 x 1/2 x 4	4,16
3/4	1075/1	208-230	56Z	X218	56A11O5313	√	\$385	F1	3.9-3.6	34	8 5/8	7 x 5/8 x 7	16,21

OEM: Taco

Single Split Phase, Open Air Over

Features:

- Resilient ring mounting
- 4722 replaces Taco No. 110-388, Marathon No. 48S17D1027, 48S17D2102
- 4404 replaces GE No. 5KH32EG129GA, Marathon No. 48S17D1084
- UL Recognized and CSA Certified



HP	RPM	VOLTS	FRAME	CAT. NO.	MODEL NO.	STOCK	LIST PRICE	MULT. SYMB.	F.L. AMPS	WEIGHT	FRAME LENGTH	SHAFT DIM.	FOOT NOTES
1/12	1800	115	48Y	4722	5KH39QN5558T	√	\$116	F1	2.1	12	7.29	1/2 x 1	4
1/8	1800	115	48Y	4404	5KH39QN5550X	√	\$126	F1	2.6	11	8.93	1/2 x 1 1/2	4

OEM: Tyler

PSC, Open Air Over

Features:

- Resilient ring thru-bolt mounting
- Replaces Tyler No. 760, Fasco No. D870, & A.O. Smith No. OTY1024
- Ball bearings
- Capacitor included

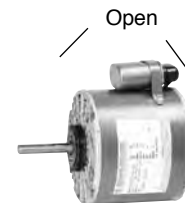

HP	RPM	VOLTS	FRAME	CAT. NO.	MODEL NO.	STOCK	LIST PRICE	MULT. SYMB.	F.L. AMPS	WEIGHT	FRAME LENGTH	SHAFT DIM.	FOOT NOTES
1/4	1625/1	208-230	48Y	X270	48A17O149	√	\$216	F1	1.9	12	4 3/4	1/2 x 2 1/2	16

Replacements listed may not be an exact duplicate of the original motor

OEM: Warren PSC, Open Air Over

Features:

- Resilient ring mounting
- Ball bearings
- Capacitor included

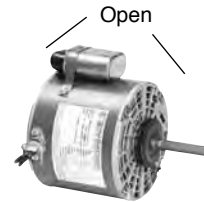

HP	RPM	VOLTS	FRAME	CAT. NO.	MODEL NO.	STOCK	LIST PRICE	MULT. SYMB.	F.L. AMPS	WEIGHT	FRAME LENGTH	SHAFT DIM.	FOOT NOTES
1/3	1075/1	208-230	48Y	X268	48A11O1239	✓	\$221	F1	3.0	14	4 3/4	1/2 x 2 7/8	15

OEM: York PSC, Open Air Over

Features:

- Round belly band mounting
- Replaces York No. K44HXJAF-4955 & Fasco No. D873, A.O. Smith No. OYK1056, Magnetek No. 468
- Ball bearings
- Capacitor not included, see Accessories section

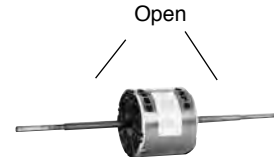

HP	RPM	VOLTS	FRAME	CAT. NO.	MODEL NO.	STOCK	LIST PRICE	MULT. SYMB.	F.L. AMPS	WEIGHT	FRAME LENGTH	SHAFT DIM.	FOOT NOTES
1/2	1050	230	48Y	X295	48A11O1410	✓	\$197	F1	3.9	19	5	9 1/4x1 2/9 1/8	15

Pedestal Fan, PSC, TEAO 48 Frame, Yoke Mount

Features:

- Heavy gauge steel frame and yoke fan shroud mounted by four 7/8" extended stud bolts on 5-1/8" bolt circle
- Single and multi-speed models as noted
- Automatic reset thermal protector
- 1/2" x 2-1/2" long shaft with two flats, 90° apart
- 1.0 Service Factor
- Ball bearings (except as noted)
- Capacitor included
- UL Recognized and CSA Certified



HP	RPM	VOLTS	FRAME	CAT. NO.	MODEL NO.	STOCK	LIST PRICE	MULT. SYMB.	F.L. AMPS	WEIGHT	FRAME LENGTH	SHAFT DIM.	FOOT NOTES
1/4	1625/1	115/230	48Y	X920	48A17T2005	✓	\$203	F1	3.6/1.8	22	7.3	10.56	17
	1075/2	115	48Y	X923	48A11T2024	✓	\$237	F1	3.2	18	6.5	9.81	17
1/3	1625/1	115/230	48Y	X921	48A17T2006	✓	\$221	F1	3.8/1.9	24	7.8	11.06	17
	1075/2	115	48Y	X924	48A11T2025	✓	\$256	F1	4.2	19	6.5	9.81	17
1/2	1625/1	115/230	48Y	X922	48A17T2007	✓	\$244	F1	5.4/2.7	27	8.0	11.31	17
	1075/2	115	48Y	X925	48A11T2026	✓	\$285	F1	5.7	25	7.5	10.81	17

Replacements listed may not be an exact duplicate of the original motor

Air Compressor, Single Phase

Dripproof, Rigid Base



Features:

- Capacitor start / capacitor run design for low amps and high efficiency, as noted
- High starting and breakdown torque
- Heavy gauge steel frame and base
- Continuous duty at nameplate ratings
- Thermal protection, as noted
- UL Recognized and CSA Certified

HP	RPM	VOLTS	FRAME	OVER LOAD	CAT. NO.	MODEL NO.	STOCK	LIST PRICE	MULT. SYMB.	F.L. AMPS	WEIGHT	"C" DIM.	FOOT NOTES
1/2	3600	115	56	MANUAL	9031	5KC49MN2043Y	√	\$215	F1	11.5	20	11.14	2,17
	1800	115/208-230	56	MANUAL	C169	5KC49GN0010Y	√	\$284	F1	8.8/4.4	21	10.38	2
3/4	3600	115	56	MANUAL	9032	5KC49MN2049Y	√	\$250	F1	12.5	27	11.14	2,17
	1800	115/208-230	56	MANUAL	K016	56B17D56	√	\$348	F1	11.0/5.5	25	11.47	1
1	3600	115/230	56	MANUAL	9033	5KC49NN2050Y	√	\$285	F1	16.0/8.0	23	11.14	d,2,17
	3600	115/208-230	56	MANUAL	D010	56B34D2029	√	\$287	F1	10.6/5.5-5.3	23	11.72	1
	1800	115/208-230	56	MANUAL	C1480	5KC49PN0161Y	√	\$379	F1	13.6/6.8	31	11.38	2
1 1/2	3600	115/208-230	56	MANUAL	C704	5KC49PN2521Y	√	\$369	F1	21.3/10.6	31	11.91	2
	1800	115/208-230	56H	MANUAL	G951	56C17D5308	√	\$443	F1	18.0/9.3-9.0	39	12.44	2,5,7
2	3600	115/208-230	56H	MANUAL	9035	5KCR48TN2650Y	√	\$464	F1	15.0/7.5	38	11.14	ES,1,17
	1800	115/208-230	145T	MANUAL	I127	145TBDR5337	√	\$534	S1	18.8/10.2-9.4	48	13.49	1,7
3	3600	230	56H	MANUAL	9036	5KCR48UN2653Y	√	\$602	F1	15.0	40	11.44	ES,1,17
	1800	230	184T	NONE	Z502	184TBDR5326	√	\$559	S1	12.6	51	14.27	1
SPCL	3600	230	56	MANUAL	9040	5KCR48UN2654Y	√	\$542	F1	15.0	40	12.1	ES,1
5	3600	230	56H	MANUAL	9038	5KCR49ZN2151U	√	\$644	F1	21.0	49	15.04	ES,1,5,17
	3600	230	56H	MANUAL	D017	56B34D5302	√	\$640	F1	20.0	55	13.94	1,5
	3600	230	184T	NONE	Z504	184TBDR5301		\$785	S1	20.0	62	14.77	1
	1800	208-230	184T	MANUAL	I119	184TBDR7375	√	\$891	S1	25.0-24.1	83	16.22	1
	1800	208-230	184T	NONE	I114A	184TBDW7026	√	\$686	S1	23.0-21.0	82	14.69	1,13
	1800	208-230	184T	NONE	Z506A	184TBDW7656		\$672	S1	22.0-20.0	81	15.21	1,13
7 1/2	3600	208-230	184T	NONE	I108A	184TBDW7001	√	\$770	S1	34.3-31.0	103	16.69	1,13
	3600	208-230	213T	NONE	I105	213TCDW7001	√	\$1,047	S1	40.0-37.0	102	16.55	2
	1800	208-230	215T	NONE	I115	215TBDW7026	√	\$1,027	S1	37.2-34.5	115	18.05	1
10	1800	208-230	215T	NONE	I116	215TBDW7028	√	\$1,322	S1	49.0-44.0	140	19.3	1

DEFINITE PURPOSE

Cooling Tower: Two-Speed-One Winding, Variable Torque Blue Chip® Severe Duty, XRI® Three Phase, Totally Enclosed, Rigid Base

Applications:

Cooling towers, Fan and Blowers, and other severe duty environments where long life and ultra-high efficiency are desired. Guaranteed efficiencies offer an eXtra Return on your Investment when using these premium efficiency motors on high cycle or long run applications. Replacement for two-speed Marley cooling tower motors.

Features:

- Blue Chip® quality, 100% cast iron construction for rigidity and reduced vibration
- Internal and external epoxy paint
- Class F insulation
- 1.15 Service Factor
- Extended grease tubes, regreasable in service
- T-drains provided for effective drainage (Installed in both endshields)
- Shaft Slinger
- Forsheda seals on both ends
- Actual test and vibration data supplied with each motor
- Ball Bearings
- UL Recognized and CSA Certified
- Three year warranty
- Horizontal mounting only; consult Engineering for Vertical mounting



IP55

DEFINITE PURPOSE

HP	RPM	VOLTS	FRAME	CAT. NO.	MODEL NO.	STOCK	LIST PRICE	MULT. SYMB.	NOM. EFF.	F.L. AMPS	WEIGHT	"C" DIM.	FOOT NOTES
3/7.5	1800/900	460	184T	Y380	184TTFS7290		\$1,384	S3	85.5	4.0/1.75	141	16.19	2,17
5/1.25	1800/900	460	213T	Y381	213TTFS7238		\$1,530	S3	89.5	6.0/2.4	199	19.72	
7.5/1.9	1800/900	460	215T	Y382	215TTFS7290	√	\$1,983	S3	89.5	9.0/3.1	142	19.72	
10/2.5	1800/900	460	254T	Y383	254TTFNA7210		\$2,390	S3	90.2	12.0/4.0	360	23.52	
15/3.75	1800/900	460	256T	Y384	256TTFNA7250	√	\$2,985	S3	90.2	18.0/6.0	381	25.27	
20/5	1800/900	460	284T	Y385	284TTFNA7240	√	\$3,725	S3	91.7	24.0/8.5	489	26.34	
25/6.25	1800/900	460	286T	Y386	286TTFNA7260	√	\$4,347	S3	91.7	31.0/11.0	168	27.84	
30/7.5	1800/900	460	324T	Y387	324TTFS7290	√	\$5,305	S3	91.0	35.0/11.2	668	28.87	
40/10	1800/900	460	326T	Y388	326TTFS9210	√	\$6,630	S3	87.5	46.0/14.6	451	30.37	
50/13	1800/900	460	364T	Y389	364TTFS9234	√	\$8,432	S3	92.4	61.0/24.0	958	31.50	
60/15	1800/900	460	365T	Y390	365TTFS9230	√	\$12,204	S3	92.4	75.0/25.0	1000	32.50	
75/18.75	1800/900	460	405T	Y391	405TTFS7297		\$15,786	S3	94.1	83.0/27.0	1331	37.12	1
100/25	1800/900	460	444T	Y392	444TTFS7262		\$19,093	S3	94.1	113/37.5	1781	41.25	

Blue shaded areas are Cast Iron Frames

Multi-Speed: Two-Speed, One-Winding, Variable Torque

Three Phase, Dripproof, Rigid Base

Applications:

Commercial and industrial fans, blowers, pumps, and other machinery that have variable torque characteristics. Prolonged use at low speed can result in significant energy savings. Dripproof motors are intended for use in environments that are relatively clean and dry. For use outdoors an enclosure or drip cover may be required (see Accessories section).



Features:

- Ball Bearings
- 1.15 Service Factor
- UL Recognized and CSA Certified

HP	RPM	VOLTS	FRAME	CAT. NO.	MODEL NO.	STOCK	LIST PRICE	MULT. SYMB.	NOM. EFF.	F.L. AMPS	WEIGHT	"C" DIM.	FOOT NOTES
3/7.5	1800/900	200-230	182T	Y1484	182TTDW7412	✓	\$651	S3	82.7	8.8-3.8/8.0-3.6	65	14.19	F,13
	1800/900	460	182T	Y485A	182TTDW7203		\$651	S3	82.7	4.0/1.8	58	13.19	13,25
5/1.25	1800/900	200-230	184T	Y486	184TTDR7287	✓	\$912	S3	85.5	15.0-14.0/6.0-6.2	87	14.72	d,F,13,25
	1800/900	200-230	184T	Y486A	184TTDW7287	✓	\$912	S3	85.5	14.5-13.8/5.6-6	40	14.19	F,13
	1800/900	460	184T	Y1487	184TTDW7209	✓	\$912	S3	85.5	6.9/3.0	80	14.72	13
7.5/1.88	1800/900	200-230	213T	Y488	213TTDW7202		\$1,131	S3	86.5	21.6-19.8/7.6-7.8	110	17.30	
	1800/900	460	213T	Y489	213TTDW7201	✓	\$1,131	S3	87.5	9.6/3.6	118	17.30	
10/2.5	1800/900	200-230	215T	Y490	215TTDW17206		\$1,429	S3	86.5	29.0-26.4/10.0-10.0	87	18.55	F,13
	1800/900	460	215T	Y491	215TTDW7201		\$1,429	S3	86.5	12.5/4.5	106	17.30	
15/3.75	1800/900	460	256T	Y492	256TTDX7207		\$1,876	S3	87.5	18.4/6.1	197	22.32	
20/5	1800/900	460	284T	Y493	284TTDP7202		\$2,335	S3	87.5	25.0/8.0	320	23.49	

Blue shaded areas are Cast Iron Frames

Multi-Speed: Two-Speed, Two-Winding, Variable Torque

Additional Features: • Economical two-winding design

HP	RPM	VOLTS	FRAME	CAT. NO.	MODEL NO.	STOCK	LIST PRICE	MULT. SYMB.	NOM. EFF.	F.L. AMPS	WEIGHT	"C" DIM.	FOOT NOTES
1/25	1800/900	460	145T	Y465	145TTDR5701	✓	\$785	S3	79.5	1.5/0.75	42	12.99	5,13
1/44	1800/1200	200-230	145T	Y449	145TTDR5703	✓	\$785	S3	80.0	3.4-3.2/2.0-2.0	42	12.99	5,13
	1800/1200	460	145T	Y450	145TTDR5704		\$785	S3	78.5	1.5/1.0	39	12.49	5,13
1.5/37	1800/900	460	145T	Y466	145TTDR5702	✓	\$861	S3	78.5	2.2/1.1	47	13.49	5,13
1.5/67	1800/1200	200-230	145T	Y451	145TTDR5705	✓	\$861	S3	80.0	5.0-4.8/2.6-2.9	47	13.49	5,13
	1800/1200	460	145T	Y452	145TTDR5706	✓	\$861	S3	78.5	2.3/1.3	42	12.99	5,13
2/5	1800/900	460	182T	Y467A	182TTDW7411	✓	\$949	S3	82.0	2.8/2.15	68	13.19	13
2/88	1800/1200	200-230	182T	Y453	182TTDR7413	✓	\$949	S3	81.0	6.5-6.3/3.5-3.5	66	13.72	d,13,25
	1800/1200	200-230	182T	Y1453	182TTDW7413	✓	\$949	S3	76.4	6.6-6.5/3.8-4	60	12.69	13
2/9	1800/1200	460	182T	Y409	182TTDR7211	✓	\$949	S3	80.0	3.0/1.7	55	12.72	25
	1800/1200	460	182T	Y409A	182TTDW7211	✓	\$949	S3	76.4	3.3/2.0	60	12.69	13
3/7.5	1800/900	460	184T	Y468	184TTDR7230	✓	\$988	S3	82.5	4.3/1.8	68	13.72	d,25
	1800/900	460	184T	Y468A	184TTDW7230	✓	\$988	S3	82.5	4/2.75	68	13.72	13
3/1.3	1800/1200	200-230	184T	Y454	184TTDR7286	✓	\$988	S3	82.5	9.3-8.5/4.9-4.6	79	14.72	d,13,25
	1800/1200	200-230	184T	Y454A	184TTDW7286	✓	\$988	S3	82.0	9.0-8.6/4.6-5	74	13.69	13
	1800/1200	460	184T	Y412	184TTDR7215	✓	\$988	S3	82.5	4.6/2.7	69	13.72	d,25
	1800/1200	460	184T	Y412A	184TTDW7215	✓	\$988	S3	82.0	4.3/2.5	74	13.69	13
5/1.25	1800/900	460	215T	Y469	215TTDW7205	✓	\$1,382	S3	86.5	6.8/3.1	118	17.30	
5/2.22	1800/1200	200-230	215T	Y455	215TTDW7204	✓	\$1,382	S3	85.5	14.5-13.0/7.3-7.0	116	17.30	
	1800/1200	460	215T	Y415	215TTDW7203	✓	\$1,382	S3	85.5	6.5/3.5	106	17.30	
7.5/1.9	1800/900	460	254T	Y470	254TTDX7201		\$1,715	S3	85.5	10.5/4.1	135	20.57	
7.5/3.3	1800/1200	200-230	254T	Y456	254TTDX7278	✓	\$1,715	S3	87.5	20.8-18.4/11.0-10.2	175	22.32	
	1800/1200	460	254T	Y418	254TTDX7208	✓	\$1,715	S3	84.0	10.0/5.6	154	20.57	
10/2.5	1800/900	460	256T	Y471	256TTDX7253		\$2,126	S3	86.5	12.9/5.6	145	22.32	
10/4.4	1800/1200	200-230	256T	Y457	256TTDX7263		\$2,126	S3	88.5	28.0-26.0/15.0-14.0	214	22.32	
	1800/1200	460	256T	Y458	256TTDX7264	✓	\$2,126	S3	87.5	12.0/6.5	214	22.32	
15/3.8	1800/900	460	284T	Y472	284TTDP7205		\$2,844	S3	88.5	18.0/6.5	300	23.49	
15/6.7	1800/1200	460	284T	Y459	284TTDP7221	✓	\$2,844	S3	87.5	18.5/9.5	325	23.49	
20/5	1800/900	460	286T	Y473	286TTDP7251	✓	\$3,543	S3	88.5	25.0/8.5	321	24.99	
20/8.9	1800/1200	460	286T	Y460	286TTDP7217	✓	\$3,543	S3	88.5	25.0/12.0	326	24.99	

Blue shaded areas are Cast Iron Frames

Instant Reversing Single Phase

Features:

- Thermal protection, as noted
- Electronic instant reverse switch
- Extended clamp screws for mounting belt guard or accessories
- Three pole, double throw reversing switch supplied by customer



Capacitor Start, Dripproof

HP	RPM	VOLTS	FRAME	OVER LOAD	CAT. NO.	MODEL NO.	STOCK	LIST PRICE	MULT. SYMB.	F.L. AMPS	WEIGHT	"C" DIM.	FOOT NOTES
1/4	1800	115	48	NONE	CG382	5KC35GNA488	✓	\$301	F1	5.2	14	9.57	20
1/3	1800	115	56	MANUAL	CG384	5KC35JNA489Y	✓	\$371	F1	6.3	16	9.89	20
		115	56	NONE	CG383	5KC35JNA489	✓	\$366	F1	6.3	15	9.89	20
1/2	1800	115/230	56	MANUAL	C1459	5KC46GN0251Y	✓	\$416	F1	8.8/4.4	21	10.78	19
		115/230	56	NONE	C1458	5KC46GN0251	✓	\$395	F1	8.8/4.4	21	10.78	19
3/4	1800	115/230	56	MANUAL	C1461	5KC46LN0252Y	✓	\$474	F1	13.2/6.6	25	10.78	19
		115/230	56	NONE	C1460	5KC46LN0252	✓	\$459	F1	13.2/6.6	25	10.78	19
1	1800	115/230	56	NONE	C1469	5KC49PN0253	✓	\$553	F1	13.6/6.8	31	11.38	18



Capacitor Start, TEFC

HP	RPM	VOLTS	FRAME	OVER LOAD	CAT. NO.	MODEL NO.	STOCK	LIST PRICE	MULT. SYMB.	F.L. AMPS	WEIGHT	"C" DIM.	FOOT NOTES
3/4	1800	115/230	56	MANUAL	C1489	5KC46PN0359Y	✓	\$583	F1	11.0/5.5	31	11.83	17



PSC, Dripproof

HP	RPM	VOLTS	FRAME	OVER LOAD	CAT. NO.	MODEL NO.	STOCK	LIST PRICE	MULT. SYMB.	F.L. AMPS	WEIGHT	"C" DIM.	FOOT NOTES
1/3	1625/1325	115	56	MANUAL	P254	5KCP35KNB650U	✓	\$371	F1	3.8	18	9.94	17
1/2	1625/1325	115	56	MANUAL	PG252	5KCP36NNB670U	✓	\$395	F1	5.4	18	10.33	17
		115	56	MANUAL	P253	5KCP36NNB671U	✓	\$416	F1	5.4	18	10.30	12,17



PSC, TENV

HP	RPM	VOLTS	FRAME	OVER LOAD	CAT. NO.	MODEL NO.	STOCK	LIST PRICE	MULT. SYMB.	F.L. AMPS	WEIGHT	"C" DIM.	FOOT NOTES
1/2	1625	115	48	AUTO	P247	5KCP35NNA670T	✓	\$327	F1	5.8	18	9.42	17,94,96

Kiln Duty, XRI® Premium Efficiency Blue Chip® Severe Duty Teao, Rigid Base, Three Phase



Applications:

Fans found in kilns and other high ambient environments where long life and high efficiency are desired. These TEAO motors must be mounted within the airstream for proper cooling. Suitable for use on variable frequency drives.

Features:

- Blue Chip quality, 100% cast iron construction for rigidity and reduced vibration
- Internal and external epoxy paint
- CR²⁰⁰ Corona resistant magnet wire
- Class H insulation system
- Normally closed thermostats (one per phase, Class H)
- Heat stabilized ball bearings and high temperature grease
- Suitable for inverter use for 20:1 Variable Torque with 1.0 S.F. in 90°C ambient
- Suitable for 90°C ambient at 1.15 S.F. or 100°C ambient at 1.0 S.F.
- Extended grease tubes, regreasable in service
- 8 Foot Leads
- UL Recognized and CSA Certified

DEFINITE PURPOSE

HP	RPM	VOLTS	FRAME	CAT. NO.	MODEL NO.	STOCK	LIST PRICE	MULT. SYMB.	NOM. EFF.	F.L. AMPS	WEIGHT	"C" DIM.
1	1200	460	145T	S501	145TTTN18577		\$1,309	E9	80.0	1.7	59	11.43
2	1800	460	145T	S503	145TTTN18531		\$1,309	E9	85.5	2.8	68	11.43
	1800	575	145T	S553	145TTTN18532		\$1,309	E9	85.5	2.3	69	11.43
	1200	460	184T	S504	184TTTS18577		\$1,810	E9	87.5	3.0	115	13.71
	1200	575	184T	S554	184TTTS18578		\$1,810	E9	87.5	2.4	115	13.71
	1800	460	182T	S506	182TTTS18532		\$1,769	E9	90.2	3.9	99	13.71
3	1200	460	213T	S507	213TTTS17077		\$1,922	E9	89.5	4.3	175	15.69
	1200	575	213T	S557	213TTTS17078		\$1,922	E9	89.8	3.5	175	15.69
	1200	460	215T	S510	215TTTS17077	✓	\$2,213	E9	87.5	6.9	185	17.19
5	1200	575	215T	S560	215TTTS17078	✓	\$2,213	E9	88.5	5.5	200	17.19
	7 1/2	1200	460	254T	S513	254TTTNA17077	✓	\$2,714	E9	90.2	9.8	660
7 1/2	900	575	256T	S564	256TTTNA18601		\$3,040	E9	88.5	8.6	310	22.35
	10	1200	460	256T	S516	256TTTNA18578	✓	\$3,112	E9	91.0	12.8	140
1200		575	256T	S566	256TTTNA18577		\$3,112	E9	91.0	10.2	425	22.35
900		460	284T	S517	284TTTNA18601		\$3,226	E9	88.5	15.2	475	23.44
900		575	284T	S567	284TTTNA17101	✓	\$3,226	E9	88.5	12.2	457	23.44
15	1800	460	254T	S518	254TTTNA18530		\$2,561	E9	92.4	18.2	276	20.60
	1200	460	284T	S519	284TTTNA16577		\$3,727	E9	91.7	20.5	425	23.44
	1200	575	284T	S569	284TTTNA18577		\$3,727	E9	91.7	16.4	475	23.44
20	1200	460	286T	S522	286TTTNA18577		\$4,082	E9	91.7	27.0	520	24.94
	900	460	324T	S523	324TTTS18601		\$4,988	E9	90.2	29.5	536	26.00
25	1200	460	324T	S525	324TTTS18577		\$5,128	E9	92.4	33.0	675	26.00
30	1200	460	326T	S528	326TTTS18577		\$5,430	E9	93.0	38.0	725	27.50

Blue shaded areas are Cast Iron Frames

Oil Well Pump, Three Phase

Dripproof, Rigid Base



Applications:

For use on walking beam pumps found in oil field service.

Features:

- NEMA design D for extra high starting and breakdown torques
- Normally closed thermostats (one per phase, Class F)
- Fully guarded with screens on all external openings
- Copper bar rotor on 500 frame
- Low starting current with 5-8% slip
- Class F insulation
- F2 conduit box location
- Ball bearings (except as noted)
- Shaft slinger
- Special "oil well" duty
- 1.15 Service Factor

DEFINITE PURPOSE

HP	RPM	VOLTS	FRAME	CAT. NO.	MODEL NO.	STOCK	LIST PRICE	MULT. SYMB.	NOM. EFF.	F.L. AMPS	WEIGHT	"C" DIM.	FOOT NOTES
3	1200	230/460/796	215T	Y201	215TTDW7376		\$1,295	S7	82.5	10.6/5.3/3.1	104	17.30	
5	1200	230/460/796	215T	Y202	215TTDW7377	✓	\$1,496	S7	84.0	16.6/8.3/4.8	118	17.30	
7 1/2	1200	230/460/796	254T	Y203	254TTDX7377		\$1,925	S7	85.5	22.0/11.0/6.4	220	21.29	
10	1200	230/460/796	256T	Y204	256TTDX7391	✓	\$2,375	S7	86.5	29.0/14.5/8.4	462	23.04	
15	1200	230/460/796	284T	Y215	284TTDP7692	✓	\$2,872	S7	87.5	41.0/20.5/11.9	330	23.44	
20	1200	230/460/796	286T	Y216	286TTDP7689	✓	\$3,495	S7	87.5	53.0/26.5/15.3	368	24.94	
25	1200	460/796	324T	Y217	324TTDP7687	✓	\$4,290	S7	88.5	34.0/19.7	460	26.00	
30	1200	460/796	326T	Y218	326TTDP7697	✓	\$5,128	S7	88.5	40.0/23.1	498	27.50	
40	1200	460/796	365T	Y209	365TTDS7383		\$6,733	S7	87.5	48.0/27.7	713	29.93	
50	1200	460/796	404T	Y210	404TTDS7387	✓	\$8,135	S7	87.5	60.0/34.5	951	32.81	d
60	1200	460/796	405T	Y211	405TTDS7697		\$9,595	S7	87.5	71.0/41.0	1018	34.31	
75	1200	460/796	444T	Y212	444TTDS8699	✓	\$10,772	S7	90.2	91.5/53.0	1239	38.06	
100	1200	460/796	445T	Y213	445TTDS9477		\$14,363	S7	88.5	124/71.5	1327	40.06	
125	1200	460/796	505U	Y219	505UTDS1584		\$21,042	S7	90.2	175/101	1995	45.19	RB
150	1200	460/796	505U	Y220	505UTDS1590		\$22,486	S7	91.0	175/101	2285	45.19	RB

Blue shaded areas are Cast Iron Frames

Pressure Washer, Single Phase Dripproof

Features:

- Ball bearings, shaft end mechanically locked on C-face models
- Heavy gauge steel constructions
- Capacitor start/capacitor run design for higher efficiency, as noted
- Continuous duty, 1.15 Service Factor (except as noted)
- Thermal protection on some models
- UL Recognized and CSA Certified



Rigid Base

HP	RPM	VOLTS	FRAME	OVER LOAD	CAT. NO.	MODEL NO.	STOCK	LIST PRICE	MULT. SYMB.	F.L. AMPS	WEIGHT	"C" DIM.	FOOT NOTES
3/4	3600	115	56	MANUAL	9032	5KC49MN2049Y	✓	\$250	F1	12.5	27	11.14	2,17
	1800	115	56	AUTO	9030	5KC49NN0222X		\$348	F1	10.5	16	11.14	2,17
	1800	115/208-230	56	MANUAL	K016	56B17D56	✓	\$348	F1	11.0/5.5-5.5	25	11.47	1
1	3600	115/208-230	56	MANUAL	D010	56B34D2029	✓	\$287	F1	10.6/5.5-5.3	23	11.72	1
	1800	115/230	56	MANUAL	C1480	5KC49PN0161U	✓	\$379	F1	13.6/6.8	31	11.38	2
1 1/2	3600	115/208-230	56	MANUAL	G987	56B34D2021		\$390	F1	14.8/8.0-7.4	26	11.72	1
	1800	115/208-230	56H	MANUAL	G958	56B17D5323	✓	\$461	F1	13.2/7.2-6.6	37	11.94	1,5,14
2	3600	115/208-230	56H	MANUAL	G976	56B34D5304		\$483	F1	17.6/9.7-8.8	34	11.44	1,5,14
	1800	115/208-230	145T	MANUAL	I127	145TBDR5337	✓	\$534	S1	18.8/10.2-9.4	48	13.49	1,14
	1800	115/208-230	56H	MANUAL	G979	56B17D5319		\$608	F1	18.8/10.2-9.4	47	13.44	1,5,14
3	3600	208-230	56H	MANUAL	G996	56B34D5334		\$619	F1	14.2-12.5	44	12.44	1,5,14
	1800	208-230	184T	NONE	I128	184TBDR7631	✓	\$624	S1	15.4-13.7	71	15.22	d,1
	1800	208-230	184T	NONE	I128A	184TBDW7631	✓	\$624	S1	13.8-12.8	71	13.69	1,13
	1800	208-230	184T	MANUAL	I130A	184TBDW7630	✓	\$676	S1	13.8-12.8	70	13.69	1,13
5	1800	208-230	184T	MANUAL	I119	184TBDR7375		\$891	S1	25.0-24.1	83	16.22	1
	1800	208-230	184T	NONE	I131	184TBDR7632	✓	\$900	S1	25.0-24.1	83	16.22	d,1
	1800	208-230	184T	NONE	I131A	184TBDW7632	✓	\$900	S1	22.0-20.0	89	15.19	1,13

C-Face with Rigid Base

HP	RPM	VOLTS	FRAME	OVER LOAD	CAT. NO.	MODEL NO.	STOCK	LIST PRICE	MULT. SYMB.	F.L. AMPS	WEIGHT	"C" DIM.	FOOT NOTES
1 1/2	3600	115/208-230	56C	MANUAL	K212	56B34D2018		\$409	F1	14.8/8.0-7.4	26	11.72	
	1800	115/208-230	56HC	MANUAL	G290	56B17D5328		\$478	F1	13.2/7.2-6.6	39	11.94	5
2	3600	115/208-230	56HC	MANUAL	G294	56B34D5307		\$499	F1	16.8/9.4-8.4	34	11.44	5
	1800	115/208-230	56HC	MANUAL	K232	56B17D5322	✓	\$596	F1	18.8/10.2-9.4	49	13.43	5
3	3600	208-230	56HC	MANUAL	K219	56B34D5336		\$635	F1	14.2-12.5	42	12.44	5
	1800	208-230	184TC	MANUAL	I305	184TBDR7628		\$741	S1	15.4-13.7	83	15.96	1
5	1800	208-230	184TC	MANUAL	I308	184TBDR7634		\$1,020	S1	25.0-24.1	97	16.96	1

Pressure Washer, Single Phase

Totally Enclosed Fan Cooled

Features:

- Ball bearings, shaft end mechanically locked on C-face models
- Heavy gauge steel constructions
- Capacitor start/capacitor run design for higher efficiency, as noted
- Continuous duty, 1.15 Service Factor
- Manual reset thermal protector
- UL Recognized and CSA Certified



Rigid Base

HP	RPM	VOLTS	FRAME	CAT. NO.	MODEL NO.	STOCK	LIST PRICE	MULT. SYMB.	F.L. AMPS	WEIGHT	"C" DIM.	FOOT NOTES
3/4	3600	115/208-230	56	G379	56C34F5309	√	\$278	F1	10.6/5.3-5.3	26	12.32	2,14
	1800	115/208-230	56	G356	56C17F5308	√	\$384	F1	11.0/5.4-5.5	29	12.32	2,14
1	3600	115/208-230	56	G390	56C34F5311	√	\$315	F1	12.4/6.7-6.2	31	12.32	2,14
	1800	115/208-230	56	G373	56C17F5311	√	\$402	F1	13.4/6.8-6.7	30	12.82	2,14
1 1/2	3600	115/208-230	56	K332	56B34F5303	√	\$427	F1	12.1/6.9-6.1	37	13.32	1,14
	1800	115/208-230	56H	G378	56B17F5302	√	\$461	F1	15.2/8.2-7.6	40	13.82	1,5,14
2	1800	115/230	145T	I702	145TBFR5336	√	\$591	S1	18.8/9.4	52	14.87	1,14



C-Face with Rigid Base

HP	RPM	VOLTS	FRAME	CAT. NO.	MODEL NO.	STOCK	LIST PRICE	MULT. SYMB.	F.L. AMPS	WEIGHT	"C" DIM.	FOOT NOTES
1/2	1800	115/208-230	56C	G380	56C17F5957	√	\$355	F1	8.8/4.2-4.4	27	11.82	2
3/4	1800	115/208-230	56C	G381	56C17F5955	√	\$425	F1	11/5.4-5.5	22	12.32	2
1	1800	115/208-230	56C	G382	56C17F5956	√	\$444	F1	13.4/6.8-6.7	31	12.82	2
1 1/2	3600	115/208-230	56C	K612	56B34F5306	√	\$443	F1	12.1/6.9-6.0	37	13.32	1
	1800	115/208-230	56HC	G396	56B17F5310	√	\$506	F1	13.6/7.5-6.8	43	13.82	1,5
2	3600	115/230	56HC	K615	56B34F5312	√	\$526	F1	17.5/8.7	37	13.32	1,5
	1800	115/230	145TC	I311	145TBFR5333	√	\$716	S1	18.8/9.4	52	14.87	1
	1800	115/230	56HC	K319	56B17F5319	√	\$601	F1	18.8/9.4	50	14.82	1,5
3	3600	230	56HC	K618	56B34F5318	√	\$663	F1	11.8	51	14.82	1,5
	1800	230	184TC	I314A	184TBFW7041	√	\$896	S1	12.8	86	14.96	1,13
5	1800	230	184TC	I315A	184TBFW7034	√	\$1,069	S1	19.5	101	17.47	1,13,17

DEFINITE PURPOSE

Woodworking/Power Tool, Single Phase

Totally Enclosed, Rigid Base

Applications:

Replacement motors for table saws, planers, lathes, and other equipment found in the woodworking and metalworking trades. These totally enclosed, fan cooled motors are well suited for use in dusty and dirty environments or where wood or metal shavings are present.

Features:

- Capacitor start design for high starting torque with low amps
- Double sealed ball bearings
- Heavy gauge steel frame and base
- 1.15 Service Factor
- Manual reset thermal protector
- Dependable, dust-proof centrifugal starting switch
- On/off toggle switch and 8 foot cord with 115 volt plug included on 1/2 to 1-1/2 HP models
- UL Recognized and CSA Certified



HP	RPM	VOLTS	FRAME	CAT. NO.	MODEL NO.	STOCK	LIST PRICE	MULT. SYMB.	F.L. AMPS	WEIGHT	"C" DIM.	FOOT NOTES
1/2	1800	115/208-230	56	T010	56C17F5351	✓	\$367	F1	8.8/4.2-4.4	29	11.82	2
3/4	3600	115/208-230	56	T013	56C34F5340	✓	\$332	F1	10.6/5.3-5.3	27	12.32	2
	1800	115/208-230	56	T014	56C17F5350	✓	\$429	F1	11.0/5.4-5.5	30	12.32	2
1	3600	115/208-230	56	T015	56C34F5339	✓	\$369	F1	12.4/6.7-6.2	30	12.32	2
	1800	115/208-230	56	T016	56C17F5349	✓	\$454	F1	13.4/6.8-6.7	31	12.82	2
1 1/2	3600	115/208-230	56	T017	56B34F5332	✓	\$453	F1	14.2/7.7-7.1	33	12.82	1
	1800	115/208-230	56	T018	56B17F5328	✓	\$551	F1	13.6/7.5-6.8	44	13.73	1
2	3600	115/230	56H	T019	56B34F5333	✓	\$493	F1	17.5/8.7	36	13.41	1,5
	1800	115/230	56H	T030	56B17F5329	✓	\$608	F1	18.8/9.4	50	14.82	1,5
3	3600	208-230	145T	T031	145TBFR5309	✓	\$684	S1	13.1/11.8	51	14.87	1

50 Hertz, Three Phase

Dripproof, Rigid Base

Features:

- Ball bearings
- 1.15 Service Factor
- Nameplated 190-200-208/380-400-416 (except as noted)
- 12 Lead delta capability
- UL Recognized and CSA Certified



HP	RPM	VOLTS	FRAME	CAT. NO.	MODEL NO.	STOCK	LIST PRICE	MULT. SYMB.	NOM. EFF.	F.L. AMPS	WEIGHT	"C" DIM.	FOOT NOTES
2	1500	220/380	145T	KG319	5K49UN8052		\$458	E6	81.5	6.4/3.7	40	14.24	
	1500	190-208/380-416	145T	H952	145TTDR5647		\$458	E6	82.5	7.2-7.3/3.6-3.65	41	12.99	F,YD,5,14
3	1500	190-208/380-416	182T	H953	182TTDR8353		\$510	E6	81.5	10.0-9.8/5.0-4.9	60	13.22	F,YD,25
5	1500	190-208/380-416	184T	H954	184TTDR9040	✓	\$648	E6	82.5	16.2-15.6/8.1-7.8	80	14.72	F,YD,25
7 1/2	1500	190-208/380-416	213T	H955	213TTDW7053		\$851	E6	85.5	22.6-19.0/9.5-11.3	106	17.30	YD
10	1500	190-208/380-416	215T	H956	215TTDW7053		\$1,013	E6	88.5	31.0-29.1/15.5-14.5	135	17.30	YD
15	1500	190-208/380-416	254T	H957	254TTDX8338		\$1,341	E6	88.5	46.0-44.0/23.0-22.0	180	22.32	F,YD

MOD CENTRAL - Motor Modifications

Mod Central

Marathon Electric offers the capability to modify stock motors in a matter of days to meet our customer's special needs. Mod Central is centrally located in the motor industry's largest Distribution Center in Indianapolis, Indiana. This state-of-the-art facility stocks a vast array of motors and accessories along with a staff of skilled technicians who provide the highest quality of service. If you need motor modifications on 20 motors or less and want to avoid special engineering and manufacturing schedules, call Marathon Electric and take advantage of our **MOD CENTRAL** Motor Modification Program.

Lead-Time

All lead-times indicated are subject to availability of the stock motors and parts at the time of order placement. If a stock motor is shipped from a remote warehouse to Indianapolis for modification, the cost of the inbound freight will be added to the price of the modified motor and the delivery of the modified motor will be extended by the inbound transit time. **(Lead-times in working days are calculated from normal business hours excluding holidays and weekends and do not include the day the purchase order is received.)** Large quantities may require additional lead-time.

Mod Central Hours

The Modification Center is open from 7:00 a.m. to 5:00 p.m. CST Monday through Friday.

How to Order

First determine whether you need a kit to perform the modification, if you do not need a kit, then the modification list price includes all supplies to perform that modification. If a kit is needed, the modification list price is the labor to install the kit. The kit list price and the motor list price are not included. You must add the net price of the motor, and kit to the net price of the modification(s) to calculate the total price of the modified motor.

For example, to add a C-Face Kit and Thermostats to Catalog Motor U633, you would calculate the total price as follows:

	List Price	Mult Symbol
Kit 175191 (A653).....	\$165 list	S4
Modification MOD2L, add C-Face to 254T-256T Frame motor.....	\$195 list	S4
Modification MOD14E, add thermostats to 254T-256T Frame motor.....	\$278 list	S4
TOTAL	\$638 list	

Add the net price of U633 (\$1324 list price times (x) your motor multiplier) to the net adder for the kit and modifications (\$638 times (x) your Mod Center multiplier of S4) to find the total net price for the modified motor.

Freight Terms

Standard terms and conditions apply.

Exceptions

Some modifications do not apply to explosion proof motors.

Discount Multiplier

Discount symbol S4 applies to all list prices, except where noted.

Cancellation Policy

If a Mod Central order is cancelled after the motor is modified but before it ships, a cancellation charge of double the modification charge will be invoiced to the customer. Any Mod Central order cancelled before modifications are completed, is subject to a cancellation charge of 25% of the total modification charges for that item.

Once shipped, modified motors may not be returned for credit or restocking.

MOD CENTRAL - Motor Modifications

MODIFICATION DESCRIPTION	MODIFICATION NUMBER	PRODUCT	FRAME	LEAD-TIME DAYS*
Altitude/Ambient				
• AC Motor Altitude or Ambient Re-Rating	MOD7	All Non-EXP	48-449T	2
• AC Motor Altitude or Ambient Re-Rating	MOD7	Explosion Proof	143T-449T	2
Assembly (see Mounting)				
Bearings				
• Convert Ball to Roller (Drive End)	MOD18	TEFC	364T-449T	3
• Convert Roller to Ball (Drive End)	MOD18	TEFC	444T-449T	2
• Sealed Bearing	MOD18	All Non-EXP	143T-449T	Call
• Insulated Bearing	MOD18	Non Div 1 or 2	143T-449T	Call
Blowers				
• Axial Blower	MOD19	TEFC	213T-449T	3
Brackets				
• C-Face Non-Explosion Proof	MOD2	All Non-EXP	56-449T	2
• C-Face Explosion Proof	MOD2	Explosion Proof	56,254T-449T	Call
• C-Face IEEE 841	MOD2	All Non-EXP	143T-449T	2
• D-Flange	MOD17	All Non-EXP	254T-365T	Call
• B14 FT Flange (IEC C-Face)	MOD55	IEC	63-160	2
• B5 FF Flange (IEC D-Flange)	MOD55	IEC	63-225	2
Brake Motors				
• Brake Motors-Single Phase	MOD3	TEFC	56C	3
• Brake Motors-Three Phase	MOD3	TEFC	56C-145TC	3
• Brake Motors-Inverter Duty	MOD3	TENV	56C-326TC	3
• Electrical Modifications-Brake Coil	MOD3	Brake Motors	56-256TC	5
• Vertical Brake Mounting	MOD3	All Brakes	56-256TC	5
Conduit Box				
• Rotate Conduit Box Lead Opening	MOD56	All Non-EXP	143T-449T	2
• Convert to Cast Iron	MOD56	All Non-EXP	143T-326T	2
• Auxiliary Box (Condulet)	MOD56	All Non-EXP	182T-5013L	Call
Connections				
• SO Cord, Plug, and Switch-Single Phase	MOD0	TEFC	48-215T	Call
Drains				
• Condensation Drain Holes	MOD21	All Non-EXP	143T-449T	2
• Brass Drain & Breather	MOD21	All Non-EXP	143T-449T	2
• Stainless Steel Drain & Breather	MOD21	All Non-EXP	143T-449T	2
Drip Covers				
• Canopy Cover	MOD4	ODP, TEFC	48-256T	2
Encoders				
• Avtron AV56 - Black Max® / Blue Max®	MOD22	TENV, TEBC	56-449T	2
• Avtron HS25A & HS35A	MOD22	TENV, TEBC	56-449T	2
• Avtron M56/M85 - Black Max®/ Blue Max® brake motors	MOD24	TENV	143T-256T	2
• Northstar SL56 - Black Max®/Blue Max®	MOD22	TENV, TEBC	56-449T	2
• Northstar SL56/SL85 - Black Max®/ Blue Max® brake motors	MOD24	TENV	143T-256T	2
• Dynapar HS20, HS35R, & HSD38 - Black Max® / Blue Max®	MOD22	TENV, TEFC, TEBC	56-449T	2
• BEI HS35 - Black Max®/Blue Max®	MOD31	TENV, TEFC, TEBC	56-449T	2
• Stub Shaft (XRI®-SD & XRI®-841,TEFC only)	MOD42	TEFC	182-449T	2
Fan				
• Oversized fan (see Inverter Duty modification)	MOD43	TEFC	213T-449T	2
• Fan Removal	MOD44	All Non-EXP	56-449T	2
• Vane Axial	MOD43	All Non-Exp	143T-449T	2
Frequency				
• Frequency Re-Rate 60 Hz to 50 Hz	MOD7	All	56-449T	1
Grease/Fittings				
• Grease Relief Fittings	MOD15	All Non-EXP	143T-449T	2
• Zerk Fittings (Cast Iron Motors)	MOD15	All Non-EXP	182T-449T	2
• Low Temperature Grease	MOD0	All	48-449T	2
• High Temperature Grease	MOD0	All	48-449T	2

*Lead-time days does not include the day order is received

MOD CENTRAL - Motor Modifications

MODIFICATION DESCRIPTION	MODIFICATION NUMBER	PRODUCT	FRAME	LEAD-TIME DAYS*
Grounding				
• Conduit Box Grounding Lug	MOD20	All	48-215T	2
• On-Frame Grounding (Cast Iron Motors)	MOD20	All	143T-449T	2
• Shaft Grounding Ring	MOD20	Call	48-449T	2
Inverter Duty Motors				
• Variable Torque with Thermostats (R140)	MOD25	All	143T-449T	2
• Constant Torque with Thermostats (R142)	MOD26	All	143T-449T	2
• Constant Torque (R164)	MOD43	All	143T-449T	2
Leads				
• Reconnect Leads	MOD9	All	48-449T	2
• Terminal Lugs	MOD0	All	48-326T	2
• Remark Leads	MOD33	All	48-449T	2
• Longer Leads - Up to 24"	MOD0	All Non-EXP	48-449T	2
Mounting/Assembly (Example: F1 to F2)				
• Convert to Floor, Top, Ceiling, or Wall	MOD1	All Non-EXP	143T-449T	2
• Convert to Floor, Top, Ceiling, or Wall	MOD39	Explosion Proof	143T-449T	2
• Adjustable Bases	MOD39	All	143T-449T	2
Nameplates / Markings				
• Additional Data on Nameplate	MOD7	All	48-449T	1
• CE Marking	MOD7	All	48-449T	2
• Private Label	MOD7	All	48-449T	1
• Rotation Arrow	MOD7	Single Phase	48-215T	1
• Separate Nameplate for Customer Data	MOD7	All	48-449T	2
• Stainless Steel Nameplate	MOD7	All	48-449T	1
Packaging				
• Heat Treated Pallet	MOD29	All	48-449T	3
Paint				
• Repaint to a Marathon stock color	MOD8	All	48-449T	2-3
Screens				
• Rodent Screens	MOD0	ODP	364T-449T	Call
Service Factor				
• AC Motor Service Factor Re-Rating	MOD7	All Non-EXP	48-449T	1
Severe Duty Construction				
• Cast Iron Fan Cover and Conduit Box	MOD16	All Non-EXP	143T-449T	2
Shaft Grounding Ring (see Grounding)				
Shaft Modifications				
• Drill & Tap Hole	MOD42	All	56-449T	3
• TS Shaft	MOD42	All	284T-449T	2
• Mill Flat on Shaft	MOD0	All	56-184T	2
• Steps on Shaft	MOD0	All	143T-449T	Call
• Stub Shaft Kit	MOD42	TEFC	182T-449T	2
Space Heaters				
• Non Explosion Proof	MOD12	All Non-EXP	48-449T	2
• Explosion Proof	MOD41	Explosion Proof	56-449T	2
• IEC Frames	MOD12	IEC	100-250	2
Terminal Blocks				
• Terminal Block	MOD0	All Non-EXP	180-449T	Call
Thermal Protection				
• Thermostats - Windings	MOD14	All	56-449T	2
• Thermistors - Windings	MOD14	All	143T-449T	2
• Thermistors (including Control Module)	MOD14	All Non-EXP	143T-449T	2
• Thermocouples - Winding or Bearing	MOD0	All Non-EXP	145T-449T	2
Weatherproofing / Special Service				
• Tropical Anti-Fungus Treatment	MOD5	All	48-449T	2
• Division 2 Motors (CSA Certified)	MOD49	Blue Chip®/XRI®	143T-449T	Call

*Lead-time days does not include the day order is received



MOD CENTRAL - Stock Motors Only

Mult. Symbol is S4 (except as noted)

Contact Marathon Electric for all modification services on Explosion Proof and Blower (TEBC) motors.

NEMA MOTORS

DESCRIPTION	LIST PRICE												
	MOD #	48	56	143-145	182-184	213-215	254-256	284-286	324-326	364-365	404-405	444-445	447- 449
Altitude / Ambient	7	\$114	\$114	\$114	\$114	\$114	\$114	\$114	\$114	\$114	\$114	\$114	\$114
Bearings													
Convert Ball to Roller (Drive End)	18	-----	-----	-----	-----	-----	-----	-----	-----	\$200	\$200	\$250	\$250
Convert Roller to Ball (Drive End)	18	-----	-----	-----	-----	-----	-----	-----	-----	-----	-----	\$250	\$250
Sealed Bearings	18	\$197	\$197	\$197	\$263	\$263	\$362	\$461	\$625	\$1,084	\$1,084	\$1,478	\$1,478
Insulated Bearings	18	-----	-----	\$461	\$526	\$526	\$1,530	\$1,645	\$1,645	\$1,737	\$1,776	\$1,882	\$2,061
Blowers													
Axial Blower	19	-----	-----	-----	-----	\$308	\$270	\$270	\$270	\$520	\$520	\$520	\$520
Brackets*													
C-Face (Non-Explosion Proof)	2	-----	\$143	\$143	\$168	\$168	\$195	\$290	\$329	\$329	\$329	\$329	\$329
C-Face (Explosion Proof)	2	-----	\$238	-----	-----	-----	\$325	\$483	\$648	\$648	\$648	\$948	\$948
C-Face (IEEE 841)	2	-----	-----	\$238	\$280	\$280	\$325	\$425	\$489	\$489	\$489	\$489	\$489
D-Flange	17	-----	-----	-----	-----	-----	\$168	\$240	\$408	\$408	-----	-----	-----
Brakes													
3 lb-ft for a TEFC motor	3	-----	\$165	\$165	-----	-----	-----	-----	-----	-----	-----	-----	-----
6 lb-ft for a TEFC motor	3	-----	\$165	\$165	-----	-----	-----	-----	-----	-----	-----	-----	-----
10 lb-ft for a TEFC motor	3	-----	\$165	\$165	-----	-----	-----	-----	-----	-----	-----	-----	-----
6 lb-ft for a Black Max (TENV) motor	3	-----	\$165	\$165	\$165	\$165	-----	-----	-----	-----	-----	-----	-----
10 lb-ft for a Black Max (TENV) motor	3	-----	\$165	\$165	\$165	\$165	\$165	\$165	-----	-----	-----	-----	-----
Brake Coil (56000 Series)	3	-----	\$410	\$410	\$410	-----	-----	-----	-----	-----	-----	-----	-----
Brake Coil (87000 Series)	3	-----	-----	-----	\$510	\$510	\$510	-----	-----	-----	-----	-----	-----
Vertical Mounting - Up or Down	3	-----	-----	-----	-----	\$73	\$73	-----	-----	-----	-----	-----	-----
Conduit Box													
Rotate Conduit Box Lead Opening	56	-----	-----	\$145	\$145	\$145	\$145	\$145	\$145	\$145	\$145	\$145	\$145
Convert to Cast Iron	56	-----	-----	\$158	\$158	\$158	\$174	\$188	\$217	-----	-----	-----	-----
Auxiliary Box (Condulet)	56	-----	-----	-----	\$217	\$217	\$289	\$289	\$289	\$434	\$434	\$434	\$434
Connections:													
SO Cord, Plug, and Switch Single Phase	0	\$287	\$287	\$287	\$287	\$287	-----	-----	-----	-----	-----	-----	-----
Drains													
Condensation Drain Holes	21	-----	-----	\$171	\$171	\$171	\$191	\$191	\$191	\$191	\$191	\$191	\$191
Brass Drain & Breather	21	-----	-----	\$182	\$182	\$182	\$326	\$326	\$326	\$326	\$326	\$326	\$326
Stainless Steel Drain & Breather	21	-----	-----	\$263	\$263	\$263	\$471	\$471	\$471	\$471	\$471	\$471	\$471
Drip Cover													
Canopy Cover (ODP & TEFC Motors)	4	\$121	\$121	\$121	\$121	\$160	\$256	-----	-----	-----	-----	-----	-----
Encoders (NOTE: Multiplier Symbol E3)													
Avtron AV56	22	-----	\$0	\$0	\$0	\$0	\$0	-----	-----	-----	-----	-----	-----
Avtron HS25A	22	-----	\$0	\$0	\$0	\$0	\$0	-----	-----	-----	-----	-----	-----
Avtron HS35A	22	-----	\$0	\$0	\$0	\$0	\$0	\$0	\$0	\$0	\$0	\$0	\$0
Avtron HS35M	22	-----	\$0	\$0	\$0	\$0	\$0	\$0	\$0	\$0	\$0	\$0	\$0
Avtron M3	22	-----	\$0	\$0	\$0	\$0	\$0	\$0	\$0	\$0	\$0	\$0	\$0
BEI HS35	22	-----	\$0	\$0	\$0	\$0	\$0	\$0	\$0	\$0	\$0	\$0	\$0
Dynapar HS20	22	-----	\$0	\$0	\$0	\$0	\$0	-----	-----	-----	-----	-----	-----
Dynapar HS35R	22	-----	\$0	\$0	\$0	\$0	\$0	\$0	\$0	\$0	\$0	\$0	\$0
EPC 260	22	-----	\$0	\$0	\$0	\$0	\$0	\$0	-----	-----	-----	-----	-----
NorthStar HSD35	22	-----	\$0	\$0	\$0	\$0	\$0	\$0	\$0	\$0	\$0	\$0	\$0
NorthStar SL56	22	-----	\$0	\$0	\$0	\$0	\$0	-----	-----	-----	-----	-----	-----
Blue Max TEBC Encoders:													
Avtron HS35A	24	-----	-----	-----	-----	-----	-----	\$0	\$0	\$0	\$0	\$0	\$0
Avtron AV56	24	-----	-----	-----	-----	-----	-----	\$0	\$0	\$0	\$0	\$0	\$0
Dynapar HSD38	24	-----	-----	-----	-----	-----	-----	\$0	\$0	\$0	\$0	\$0	\$0
NorthStar SL56	24	-----	-----	-----	-----	-----	-----	\$0	\$0	\$0	\$0	\$0	\$0
Turck A02H	24	-----	-----	-----	-----	-----	-----	\$0	\$0	\$0	\$0	\$0	\$0
Blue Max Brakemotor Encoders:													
Avtron AV56	24	-----	-----	\$0	\$0	-----	-----	-----	-----	-----	-----	-----	-----
Avtron M85	24	-----	-----	-----	\$0	\$0	\$0	-----	-----	-----	-----	-----	-----
NorthStar SL56	24	-----	-----	\$0	\$0	-----	-----	-----	-----	-----	-----	-----	-----
NorthStar SL85	24	-----	-----	-----	\$0	\$100	\$0	-----	-----	-----	-----	-----	-----
Stub Shaft: (XRI®-SD & XRI®-841, TEFC only)													
	42	-----	-----	-----	\$182	\$182	\$182	\$182	\$182	\$182	\$182	\$182	\$182
Fan													
Oversized fan (Inverter Duty)	43	-----	-----	-----	-----	\$230	\$263	\$263	\$263	\$296	\$329	\$329	\$329
Fan Removal	44	-----	\$145	\$145	\$182	\$182	\$217	\$217	\$217	\$254	\$254	\$254	\$254
Vane Axial	43	-----	-----	\$315	\$315	\$315	\$315	\$315	\$315	\$315	\$315	\$315	\$315
Frequency													
Re-Rate 60Hz to 50Hz	7	\$114	\$114	\$114	\$114	\$114	\$114	\$114	\$114	\$114	\$114	\$114	\$114
Grease/Fittings													
Grease Relief Fittings	15	-----	-----	\$174	\$174	\$174	\$174	\$174	\$174	\$174	\$174	\$174	\$174
Zerk Fittings (Cast Iron Motors)	15	-----	-----	-----	\$276	\$276	\$276	\$276	\$276	\$276	\$276	\$276	\$276
Low Temperature Grease	0	\$461	\$461	\$461	\$816	\$816	\$816	\$816	\$816	\$1,092	\$1,461	\$1,461	\$1,461
High Temperature Grease	0	\$461	\$461	\$461	\$816	\$816	\$816	\$816	\$816	\$1,092	\$1,461	\$1,461	\$1,461

*Addition of C-Face Kits may result in non-NEMA "BA", dimension. For the resulting "BA" dimension consult chart found in modification section

Continued on next page.

MODIFICATIONS THROUGH MOD CENTRAL

MOD CENTRAL - Stock Motors Only

Mult. Symbol is S4 (except as noted)

Contact Marathon Electric for all modification services on Explosion Proof and Blower (TEBC) motors.

DESCRIPTION	LIST PRICE												
	MOD #	48	56	143-145	182-184	213-215	254-256	284-286	324-326	364-365	404-405	444-445	447- 449
Grounding:													
Conduit Box Grounding Lug	20	\$105	\$105	\$105	\$118	\$118	-----	-----	-----	-----	-----	-----	-----
On-Frame Grounding (Cast Iron Motors)	20	-----	-----	\$145	\$158	\$158	\$239	\$239	\$239	\$334	\$334	\$334	\$334
Shaft Grounding Ring	20	\$177	\$177	\$177	\$204	\$204	\$292	\$292	\$403	\$531	\$553	\$776	\$776
Inverter Duty Motors:													
Variable Torque (R140)	25	-----	-----	\$278	\$278	\$278	\$278	\$278	\$278	\$278	\$278	\$278	\$278
Constant Torque (fan chg, t-stats, re-nameplate)	26	-----	-----	\$278	\$278	\$278	\$441	\$441	\$441	\$441	\$542	\$542	\$542
Constant Torque (R164, fan chg, re-nameplate)	43	-----	-----	\$230	\$230	\$230	\$263	\$263	\$263	\$296	\$329	\$329	\$329
Leads:													
Reconnect Leads (Non-Explosion Proof)	9	\$168	\$168	\$168	\$249	\$249	\$439	\$439	\$439	\$575	\$575	\$575	\$575
Reconnect Leads (Explosion Proof)	40	-----	\$271	\$271	\$417	\$417	\$562	\$562	\$562	\$709	\$709	\$709	\$709
Remark Leads	33	\$176	\$176	\$176	\$176	\$176	\$176	\$176	\$176	\$176	\$176	\$176	\$176
Longer Leads - Up to 24"	0	\$138	\$138	\$138	\$207	\$207	\$362	\$362	\$362	\$507	\$507	\$507	\$507
Mounting/ Assembly: (Ex. F1 to F2):													
Non-Explosion Proof	1	-----	-----	\$209	\$209	\$209	\$278	\$278	\$278	\$347	\$347	\$347	\$347
Explosion Proof	39	-----	-----	\$487	\$487	\$487	\$555	\$555	\$555	\$626	\$626	\$626	\$626
Adjustable Motor Bases	39	-----	-----	\$143	\$168	\$168	\$195	\$290	\$329	\$329	\$329	\$329	\$329
Nameplates / Markings:													
Additional Data on Nameplate	7	\$114	\$114	\$114	\$114	\$114	\$114	\$114	\$114	\$114	\$114	\$114	\$114
CE Marking	7	\$114	\$114	\$114	\$114	\$114	\$114	\$114	\$114	\$114	\$114	\$114	\$114
Private Label	7	\$114	\$114	\$114	\$114	\$114	\$114	\$114	\$114	\$114	\$114	\$114	\$114
Rotation Arrow	7	\$114	\$114	\$114	\$114	\$114	-----	-----	-----	-----	-----	-----	-----
Stainless Steel Nameplate	7	\$114	\$114	\$114	\$114	\$114	\$114	\$114	\$114	\$114	\$114	\$114	\$114
Separate Nameplate for Customer Data	7	\$114	\$114	\$114	\$114	\$114	\$114	\$114	\$114	\$114	\$114	\$114	\$114
Packaging:													
Heat Treated Pallets	29	\$50	\$50	\$50	\$50	\$125	\$125	\$250	\$250	\$250	\$250	\$250	\$250
Paint:													
Repaint to a Marathon Stock Color	8	\$211	\$211	\$211	\$211	\$211	\$263	\$263	\$263	\$461	\$461	\$461	\$592
Screens:													
Rodent Screens	0	-----	-----	-----	-----	-----	-----	-----	-----	\$661	\$661	\$661	\$661
Service Factor:													
AC Motor Service Factor Re-Rating	7	\$114	\$114	\$114	\$114	\$114	\$114	\$114	\$114	\$114	\$114	\$114	\$114
Severe Duty Construction:													
Cast Iron Fan Cover and Conduit Box	16	-----	-----	\$147	\$181	\$200	\$225	\$225	\$225	-----	-----	-----	-----
Shaft Modifications:													
Drill & Tap Hole	42	-----	\$174	\$174	\$197	\$257	\$316	\$316	\$458	\$507	\$572	\$724	\$724
TS Shaft	42	-----	-----	-----	-----	-----	-----	\$1,579	\$1,579	\$1,711	\$1,911	\$1,911	\$1,911
Mill Flat on Shaft	0	-----	\$174	\$174	\$197	-----	-----	-----	-----	-----	-----	-----	-----
Steps on Shaft	0	-----	-----	\$217	\$289	\$289	\$362	\$434	\$507	\$579	\$651	\$724	\$796
Stub Shaft (XRI®-SD & XRI®-841,TEFC only)	42	-----	-----	-----	\$182	\$182	\$182	\$182	\$182	\$182	\$182	\$182	\$182
Space Heaters:													
Non Explosion Proof	12	\$278	\$278	\$278	\$400	\$400	\$471	\$471	\$471	\$661	\$661	\$661	\$661
Explosion Proof	41	-----	\$417	\$417	\$525	\$525	\$661	\$661	\$661	\$800	\$800	\$800	\$800
Terminal Blocks:													
Terminal Block	0	-----	-----	-----	\$294	\$294	\$351	\$351	\$351	\$358	\$358	\$437	\$437
Thermal Protection:													
Thermostats (Non Explosion Proof)	14	-----	\$278	\$278	\$278	\$278	\$278	\$278	\$278	\$278	\$278	\$278	\$278
Thermostats (Explosion Proof Motors)	14	-----	\$556	\$556	\$556	\$556	\$556	\$556	\$556	\$556	\$556	\$556	\$556
Thermistors (Non Explosion Proof motors)	14	-----	-----	\$522	\$522	\$522	\$522	\$522	\$522	\$522	\$522	\$522	\$522
Thermistors (Explosion Proof motors)	14	-----	-----	\$1,053	\$1,053	\$1,053	\$1,053	\$1,053	\$1,053	\$1,053	\$1,053	\$1,053	\$1,053
Thermistors (including Control Module)	14	-----	-----	\$1,391	\$1,391	\$1,391	\$1,391	\$1,391	\$1,391	\$1,391	\$1,391	\$1,391	\$1,391
Thermocouples - Winding or Bearing (Non XP)	0	-----	-----	\$305	\$305	\$305	\$399	\$399	\$399	\$575	\$575	\$575	\$575
Weatherproofing / Special Service:													
Tropical Anti- Fungus Treatment	5	\$242	\$242	\$242	\$242	\$242	\$313	\$313	\$313	\$382	\$382	\$382	\$382
Division 2 Hazardous (CSA Certified)	49	-----	-----	\$114	\$339	\$339	\$441	\$441	\$441	\$224	\$224	\$224	\$224
Other Modifications:	0	CONSULT FACTORY											

MODIFICATIONS THROUGH MOD CENTRAL

IEC Motors

DESCRIPTION	LIST PRICE												
	MOD #	63	71	80	90	100	112	132	160	180	200	225	250
Brackets													
FF Flange (B5)	55	\$158	\$162	\$170	\$179	\$200	\$221	\$221	\$221	\$221	\$221	\$221	-----
FT Flange (B14)	55	\$158	\$162	\$170	\$179	\$200	\$221	\$221	\$221	\$221	-----	-----	-----
Space Heaters:	12	-----	-----	-----	-----	\$405	\$502	\$502	\$554	\$554	\$554	\$639	\$693
Other Modifications:	0	CONSULT FACTORY											



MOD CENTRAL - Motor Modifications

Altitude/Ambient - MOD7 (Mult. Symbol S4)

The rating of standard motors assumes operation at sea level. Listed motors are suitable for operation at altitudes up to 3,300 feet in a maximum ambient temperature of 40°C. The ambient temperature is the temperature of the cooling medium surrounding the motor. All standard motors are suitable for operation over the range of -15°C to 40°C ambient per NEMA MG-1.

AC Motor Altitude or Ambient Re-Rating

Re-rating of a non-explosion proof motor can be done by evaluating the performance data and possibly changing the Service Factor. Contact Marathon Electric for motor capabilities prior to motor selection and modification.

Bearings - MOD18 (Mult. Symbol S4)

Most standard motors use anti-friction deep groove Conrad type ball bearing, sized for the loads to be expected in industrial applications. Roller bearings are used on the drive end to handle heavy or overhung (radial) shaft loads.

Ball to Roller Bearing

Roller bearings have the capability to handle higher radial loads than ball bearings, but must have minimum radial loads to operate correctly. Roller bearings must only be used on belted loads. They are not suitable for direct-coupled loads. (Marathon Electric recommends that belting data is reviewed by Engineering prior to converting any motor to roller bearing.) This option includes replacing only the standard drive end bearing with a roller bearing and locking the opposite bearing axially. Available on TEFC Blue Chip® and Blue Chip® XRI® motors. Lead-time is 3 days.

Roller to Ball Bearing

Larger horsepower motors are stocked standard with a roller bearing on the drive end. For direct-coupled applications, a ball bearing must be installed on the drive-end. Lead-time is 2 days.

Sealed Bearing

This modification provides the option of replacing the standard bearings in AC motors with sealed bearings and replacing the grease fittings with plugs. May not be suitable for belted applications. 250 - 449 frame, 3600RPM, no sealed bearing option. 250 - 445, 1800RPM and below, non contact sealed only. 48 - 215, All RPM's are available for sealed bearings. Consult Marathon Electric for full application details. Call for lead-time.

Insulated Bearing

Insulated bearings are used to reduce the transmission of shaft currents. In accordance with NEMA MG1-31.4.4.3, both bearings must be insulated to protect inverter-driven motors from inverter-sourced shaft voltages. The connected load must also be insulated from the motor shaft to prevent damage to it's bearings. Per UL, insulated bearings may **not** be installed in Division 1 or Division 2 hazardous locations. Division 2 will be removed from XRI®-Severe Duty and IEEE 841 motors when this modification is performed. Call for lead-time.

Blowers - MOD19 (Mult. Symbol S4)

Low rotational speeds, common in many vector drive applications, cause additional heat within the motor. As a result, these motors are designed as TENV or TEBC. Marathon Electric offers two types of blower units, depending upon the application requirements. The axial blower is available on Marathon's XRI® and XRI®-Severe Duty.

Axial Blower

Most TEBC requirements are satisfied with Marathon's axial blower. The blower motor and fan are in the same (horizontal) plane as the motor drive shaft. Lead-time is 3 days.

C-Face Brackets - MOD2 (Mult. Symbol S4)

The addition of a C-Face kit to a standard foot mount (rigid base) motor, results in a non-NEMA "BA" dimension in 143-256 Frames due to NEMA's establishment of two distinct "BA" dimensions for each of the affected frame sizes: one for rigid base motors and another for C-Face/rigid base motors. No motor manufacturer can meet both prescribed dimensions on reworked motors. The following table identifies the "BA" dimensions (defined as the distance from the center of the front foot hole to the shaft shoulder) for 143T-256T and TC frames:

* C-Face Kit (rework) "BA" dimension is identical to foot mount "BA."

NEMA FRAME	FOOT MOUNT*	C-FACE
143T-145T	2.38"	2.75"
182T-184T	2.75"	3.50"
213T-215T	3.50"	4.25"
254T-256T	4.25"	4.75"

D-Flange Brackets - MOD17

(Mult. Symbol S4)

Add a D-Flange Kit to rigid base, cast iron motor. Available on Blue Chip 254T-365T and Dripproof 284T-286T ("TTDP" and "TTDC" designs). Addition of D-Flange Kit results in non-NEMA 'BA' dimension or 254T-256T. Lead time is 2 days.

IEC Brackets - MOD55 (Mult. Symbol S4)

B14 FT Flange (IEC C-Face)

IEC mounting arrangement with the motor flange at the drive end similar to a NEMA C-Face motor. Modification includes motor disassembly and installation of a FT Flange to a Globetrotter® motor. Lead-time is 2 days.

B5 FF Flange (IEC D-Flange)

IEC mounting arrangement with the motor flange at the drive end similar to a D-Flange. Modification includes motor disassembly and installation of a FF Flange to Globetrotter® motor. Lead-time is 2 days.

Brake Motors - MOD3 (Mult. Symbol S4)

Spring-set, electrically released mechanical disc brakes are available for stopping and/or holding the load. Marathon's brakes are suitable for any angle mounting. Price of modification includes brake kit and installation.

MOD CENTRAL - Motor Modifications

MOTOR HP	BRAKEMOTOR SHAFT R.P.M.		
	LB-FT @3600	LB-FT @1800	LB-FT @1200
1/4	---	---	3
1/3	---	3	3
1/2	3	3	3
3/4	3	6	6
1	3	6	6
1 1/2	6	10	10
2	6	10	---

Brake Selection Chart

** For normal (140%) torque rating, do not apply on motors larger than 2 HP. Reduced braking torque and /or longer stopping times can result from applying an undersized brake on higher HP motors.

Brake Motors

This modification includes the addition of a 3, 6, or 10 lb-ft brake to single or three phase, TEFC, 56 (5000-series model numbers and 143/145T Frame motors. Operating voltages are 115,208, 230, 460, or 575 volts and need to be specified at time of order. Lead-time is 3 days.

Brake Motors-Inverter Duty

This modification includes the addition of a 6 or 10 lb-ft brake to Marathon Electric's Black Max® Vector Duty. Operating voltages are 115,208, 230, 460, or 575 volts and need to be specified at time of order. Lead-time is 3 days.

MOD NUMBER	BRAKE RATING	BRAKE SERIES	LIST PRICE PER MOTOR
MOD3X	3 FT/LB	56,000	\$410
	6 FT/LB		
	10 FT/LB		
	15 FT/LB		
MOD3Y	25 FT/LB	87,000	\$510
	35 FT/LB		
	50 FT/LB		
	75 FT/LB		
	105 FT/LB		

Electrical Modifications-Brake Coil (Stearns only)

Changing of brake coil allows operation of brakes at various voltages on 50 or 60 Hertz power supplies with AC supplies. Available voltage coils at 50 HZ are 110 or 110/220 volts and at 60 HZ are 115 or 115/230 volts. External brake coil lead connections will be brought out from the brake. Specify brake lead location, voltage of brake coil, frequency of supply source at time of order. Lead-time is 5 days.

Vertical Mounting

210 and 250 frames models need this modification in order to be mounted vertically.

Conduit Box - MOD56 (Mult. Symbol S4)

Standard conduit box construction is based on the individual product description, e.g. severe duty motors always have a cast iron conduit box, while some standard duty motors come with stamped steel and others cast iron. Conduit boxes meet or exceed NEC 430.12 requirements for volume. Termination of protective or monitoring devices can be provided in a separate auxiliary conduit box or conduit.

Auxiliary conduit boxes are not available on explosion proof motors.

Rotate Conduit Box Lead Opening

Standard motors have lead opening facing down toward motor base. Modifications include rotating the conduit box so the lead opening is facing the desired direction. Specify lead opening location facing conduit box. Available on non-explosion proof motors. Lead-time is 2 days.

Convert to Cast Iron

Replacement of steel conduit box with a cast iron conduit box. This modification is available on non-explosion proof cast iron motors as Marathon's explosion proof integral stock motors come standard with a cast iron conduit box. Lead-time is 2 days.

Auxiliary Box (Condulet)

A condulet can be added to the main motor conduit box for routing of accessory leads. Available on ODP and TEFC (non-explosion proof) motors. Call for lead-time.

Connections - MOD0 (Mult. Symbol S4)

Motor connections consist of special cords, plugs, and switches added to a single phase motor.

Drains - MOD21 (Mult. Symbol S4)

Standard duty motors include a weep hole as standard, while severe duty and explosion proof motors include a brass drain/breather as standard. These are located in the drive end bracket at the lowest point.

Condensation Drain Holes

Additional drilled holes will be made in both end brackets of TEFC motors. Not available on explosion proof motors. Lead-time is 2 days.

Brass Drain & Breather

Combination self-draining and breather plugs are available on TEFC motors. Not available on explosion proof motors. Lead-time is 2 days.

Stainless Steel Drain & Breather

Combination self-draining and breather plugs are available on TEFC motors. Not available on explosion proof motors. Lead-time is 2 days.

Drip Covers - MOD4 (Mult. Symbol S4)

Drip covers can be furnished on standard motors for extra protection from dripping liquids and falling objects when the motor is mounted in the vertical shaft down position. These covers are recommended on all open dripproof and totally enclosed motors for vertical shaft down operation. These covers have no vertical lifting provisions provided.

Canopy Cover (ODP and TEFC Motors)

Modification includes installation of a sheet metal drip cover to the motor for vertical shaft down mounting. Available on rolled steel Dripproof motors through 256T frame and select TEFC motors. Lead-time is 2 days.



MOD CENTRAL - Motor Modifications

Encoders - MOD22, and MOD24

(Mult. Symbol E3)

These electrical devices sense rotor speed and direction providing feedback to a control device. An encoder is a feedback device that translates mechanical motion into an electrical signal. A cable is connected from the encoder to the variable frequency drive to provide this feedback. Various mechanical provisions on the motor are required to attach the encoder. These may include C-Face on the non-drive end of the motor and special shaft extension. Various resolutions are available. All encoders offered have quadrature signal with line driver output.

Encoders can be mounted on Black Max® and Blue Max® 2000 Vector Duty motors, TENV 56 through 286T Frame, TEBC construction in 284T through 449T Frame.

Stub Shaft - MOD42 (Mult. Symbol S4)

Add Stub Shaft to Fan Cooled XRI-SD, XRI-841 (182-449 Frames) to accommodate addition of encoder on opposite drive end of motor. Lead-time 2 days.

Fan - MOD43, and MOD44 (Mult. Symbol S4)

Marathon Electric's XRI® Severe Duty and IEEE841 motors have non-sparking fans made with, high-temperature, reinforced corrosion resistant plastic that is impervious to chemical attack and has been specially designed for motor applications. All motors utilize bi-directional cooling fans.

Oversized fan (Inverter Duty) -

See MOD43 Inverter Duty

Fan Removal - MOD44

TEFC to TEAO. Convert a motor from totally enclosed, fan cooled construction to totally enclosed, air-over by removing fan cover, fan, and cutting off the fan end shaft. The modified motor must be mounted in the air stream of the driven fan for cooling purposes. The customer is responsible for providing adequate airflow over the motor. Lead-time is 2 days.

Vane Axial Fan - MOD43

Standard TEFC, TENV, and DP motors can be modified for Vane Axial fan applications. All motors will get an additional nameplate, extended leads (42" min). Fan removal on TEFC motors. A minimum airstream velocity of 3000' per minute is required. Lead-time is 2 days.

Frequency - MOD7 (Mult. Symbol S4)

Most motors commonly operate on 60 hertz (HZ) within North America. However, 50 hertz systems are common in other countries.

Frequency Re-Rate 60 HZ to 50 HZ

Marathon Electric's standard motors rated at 60 HZ may be operated at 50 HZ at reduced voltage and horsepower or Service Factor. A label containing specific re-rating information will be attached to the motor. Frame size is subject to change. Lead-time is 1 day.

Grease/Fittings - MOD0, MOD15

(Mult. Symbol S4)

Standard grease is Exxon Polyrex® EM with a bearing operating temperature range of -30° to +150°C for ball and roller bearings. Devices for installing grease into the motors, such as zerk fittings, are available.

Grease Relief Fittings - MOD15

Install standard grease relief fitting on motor. Grease relief fittings serve as an outlet to equalize pressure in the motor. Not available on explosion proof motors. Lead-time is 2 days.

Zerk Fittings (Cast Iron Motors) - MOD15

Replace standard grease plugs on motors with zerk fittings. XRI® Severe Duty and IEEE841 motors come with zerk fittings as standard equipment. Not available on explosion proof motors. Lead-time is 2 days.

Low Temperature Grease - MOD0

Bearing grease may be changed to allow for a lower operation range. The motor bearings and end bells are purged and repacked with Beacon 325 grease or equivalent with a temperature range of -60°C to +120°C. Call for lead-time.

High Temperature Grease - MOD0

Bearing grease may be changed to allow for a higher operating range. The motor bearings and end bells are purged and repacked with Dow Corning DC44M grease or equivalent with a temperature range of -40° to +204°C. Call for lead-time.

Grounding - MOD20 (Mult. Symbol S4)

All motors 48 to 449T Frame have grounding provisions per NEMA and NEC Standards. Explosion proof motors are permitted to have a frame ground, but electrical ground in conduit box must also be connected.

Conduit Box Grounding Lug

Add clamp-type grounding lug in the conduit box. Lead-time is 2 days.

On-Frame Grounding (Cast Iron Motors)

Addition of drilled and tapped hole on conduit box side of frame with installation of grounding lug. Available on non-explosion proof cast iron ratings only. Lead-time is 2 days.

Shaft Grounding Brush

Shaft grounding rings are recommended (NEMA MG1 31.4.4.3) as an effective means of bearing protection for motors operated from inverter power. One ring is adequate to bleed down inverter-sourced shaft voltages, thereby protecting both bearings for motors as large as 5011 frame. May not be installed on motors used in Division 1 or Division 2 hazardous locations or motors with a modified shaft. Does not fit all motor types. Contact factory for lead-time.

Inverter Duty - MOD25, MOD26, and MOD43

(Mult. Symbol S4)

"Inverter Duty" describes a class of motors that are capable of operation from a variable frequency drive. Many Marathon general purpose motors are suitable for most variable torque and some limited constant torque applications.

These motors do not have provisions for mounting encoders, but are suitable for use with volts/hertz or open loop vector controls. As required under Federal law, these motors comply with EPA efficiencies when operating from utility power.

MOD CENTRAL - Motor Modifications

INV. DUTY (LEADTIME 2 DAYS)

Mod #	Appl.	Mtr. Type	Mod
25	Variable Torque	Any	Add thermostats, re-nameplate
26	10:1 CT	EPAct TEFC	Oversized fan, Add thermostats, re-nameplate
	20:1 CT	XRI® TEFC	
43	10:1 CT	EPAct TEFC	Oversized fan, re-nameplate
	20:1 CT	XRI® TEFC	

Operation of motor on VFD exempts motor from Epact mandated efficiency levels.

Leads - MOD0, MOD9, and MOD33, (Mult. Symbol S4)

All motors are provided with standard leads of ample length for easy connection in the conduit box to the power leads. Lead size and material are dependent upon the class of insulation system in the motor and the current capacity required.

Reconnection - MOD9

Reconnect dual voltage 9-lead or 12-lead motors to a 3-lead single voltage. Specify desired voltage when ordering. On single phase motors, specify rotation.

*Part Winding Start and Star-delta connections are excluded.

Remark Leads - MOD33

Using cloth markers, remark leads with numbers or letters. Please specify markings. Lead-time is 2 days.

Longer Leads - MOD0

Extend leads up to two feet longer than standard by splicing. Splice will be visible in conduit box. Not available on explosion proof motors. Lead-time is 2 days.

Mounting/Assembly - MOD1, and MOD39 (Mult. Symbol S4)

Motors listed are horizontal, foot mounted. Many stock motors can be furnished in assembly positions as illustrated. Modification may include repositioning of vents, baffles, drains, and conduit box. Also end brackets are assembled and grease fittings are properly installed for operation with the motor in the position shown. No attempt is made to locate fittings on any particular side of the motor. Horizontal ball bearing motor assemblies W5, W6, W7, and W8 are not suitable for external thrusts in excess of rotor weight and half-coupling. Cast Iron ODP and TEFC, 360 and larger, are not suitable for vertical operation. Consult Engineering for TEFC Build Up. Lead-time is 2 days.

Convert to Floor, Ceiling, or Wall Mount - MOD1

Convert standard F1 mount to F2, W1, W2, W3, W4, W5, W6, W7, W8, C1, or C2 mount. The mounting symbol is required when ordering to indicate the proper mounting.

Example: Motor will be modified F1 to wall mounting W3.

FLOOR MOUNTING ASSEMBLIES

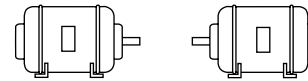

F-1

F-2

CEILING MOUNTING ASSEMBLIES

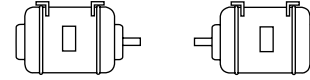

C-1

C-2

WALL MOUNTING ASSEMBLIES

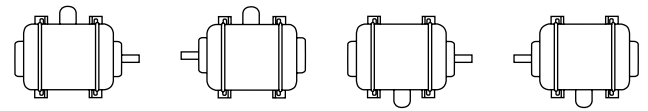

W-1

W-2

W-3

W-4

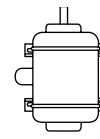

W-5

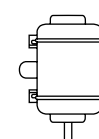

W-6

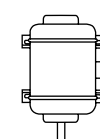

W-7

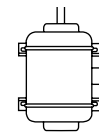

W-8

Adjustable Motor Bases - MOD39

Adjustable bases are a convenient means for adjusting belt tension or may be used as mounting plates. Adjustable motor bases are bolted to fixed base of motor prior to shipping. NEMA 215T and smaller bases feature one adjusting screw. Bases on NEMA 254T and larger feature two adjusting screws. Bases are not suitable for vertical mounting. Lead-time is 2 days.

Nameplates / Markings - MOD7 (Mult. Symbol S4)

Nameplate material is mylar or stainless steel depending on motor design and enclosure.

Additional Data on Nameplate

Motors can be re-nameplated for alternate ratings. Changes in horsepower, altitude, ambient, voltage, frequency, etc. Lead-time is 1 day.

CE Marking

CE complaint marking can be provided for all non-explosion proof NEMA frame motors. Many stock motors already contain CE marking. Lead-time is 2 days.



MOD CENTRAL - Motor Modifications

Rotation Arrow

All motors utilize bi-directional cooling fans. Specify rotation facing shaft extension on order entry form. Available on Single Phase only. Lead-time is 1 day.

Stainless Steel Nameplate

Replace existing mylar nameplate with 304 stainless steel nameplate. Lead-time is 1 day.

Separate Nameplate for Customer Data

A separate customer nameplate can be furnished. Information contained must be submitted at time of order. These additional nameplates cannot be supplied with CSA or UL Listings unless installed to motor in a Marathon Electric facility. Lead-time is 2 days.

Packaging - MOD29 (Mult. Symbol S4)

Heat Treated Pallets

ISPM-15 requires the use of heat-treated wooden packaging materials when shipping into all foreign countries (a temporary exemption exists for Canada). Modification includes replacement of wooden pallet with heat-treated pallet. Does not include export crating for ocean freight (contact factory for export packaging cost).

Paint - MOD8 (Mult. Symbol S4)

The standard paint finish is a two-coat paint system. The first coat is a rust-inhibitive primer applied to protect the castings during storage and manufacturing. The second coat is a powder coat on 48-140 frame, enamel on non-severe duty motors, or a 2-part epoxy on severe duty 180-5000 frame motors.

Special paints and color options are available if compatible and reviewed by application engineering. Paint chips and material safety data sheets are required.

Repaint to a Marathon Stock Color

Repaint motor to another Marathon Electric stock paint color. Colors include: Marathon Electric Blue Chip[®] blue, PowerWash[™] white, farm duty black, Fire Pump red, light gray, or dark gray. Specify color on order. Leadtime on enamel paint is 2 days. Epoxy paint requires a 3 day lead-time.

Screens - MOD0 (Mult. Symbol S4)

Corrosion resistant screens can be furnished over the air intake and discharge openings of cast iron dripproof motors. Dripproof motors equipped with these screens conform to the dripproof guarded definition appearing in NEMA MG-1, Part 1.

Service Factor - MOD7 (Mult. Symbol S4) A

multiplier that may be applied to the rated horsepower of a motor, which indicates a permissible horsepower loading at rated voltage and frequency.

AC Motor Service Factor Re-Rating

When a 1.15 Service Factor or higher is required, please refer to the list adder. Frame size is subject to change. Not available on explosion proof motors. Lead-time is 1 day.

Severe Duty Construction - MOD16

(Mult. Symbol S4)

This modification starts with a Marathon Blue Chip[®] Totally Enclosed cast iron frame motor and reworks it to all cast iron construction. With additional enhancements, the motor is prepared for a severe or harsh industrial environment. (Domestic Build Only)

Remove polypropylene fan cover and sheet metal conduit box from the motor and replace with cast iron fan cover, threaded and gasketed conduit box, apply epoxy finish to motor exterior, and add brass drain and breather. Lead-time is 2 days.

Shaft Modification - MOD0, and MOD42

(Mult. Symbol S4)

Motors are furnished with a single straight shaft with sled runner keyway and a rectangular key. For motors in frames 143T through 449T, a long shaft for V-Belt drive is supplied. 2-Pole motors in frames 324 through 449 and certain other 4-Pole ratings are furnished with short shafts for direct connections. Modifications are for existing shafts only. Not applicable if a new shaft is required. Call for lead-time.

Drill & Tap Hole - MOD42

Drilled radially or in the end of the shaft. Drilled and tapped in the end of the shaft. Lead-time is 3 days.

TS Shaft - MOD42

Convert "T" frame shaft to a "TS" Frame shaft. Modify motor by reducing the shaft, adding new keyway, and shortening the shaft length to the NEMA "TS" dimension. Lead-time is 2 days.

Mill Flat on Shaft - MOD0

Mill a flat on the drive end shaft extension. Provide detail of flat with the order. Lead-time is 2 days.

Steps on Shaft - MOD0

One to three reductions in shaft diameter. Customer to specify number of reductions at time of order. Call for lead time.

Stub Shaft - MOD 42 (Mult Symbol S4)

Add Stub Shaft to TEFC XRI[®]-SD, XRI[®]-841 motors (182-449 frames), to accommodate addition of HS style encoder on the opposite drive end of the motor. Lead-time is 2 days.

MOD CENTRAL - Motor Modifications

Space Heaters - MOD12, and MOD41 (Mult. Symbol S4)

Space heaters are used to prevent the build-up of condensation on the windings of the motor when the motor is not operating. Space heaters are typically installed on the end-turns of the coils.

Space Heaters - ODP & TEFC - MOD12

Space heaters can be furnished on dripproof and totally enclosed motors. Heater leads are normally brought out to the motor conduit box. Heater voltage is available in three voltages for 60 Hz operation of 115, 230, or 460 volt, single-phase. Space heaters are sized per NEMA standards. Lead-time is 2 days.

Space Heaters - IEC Frames - MOD12

Space heaters can be furnished on IEC motors. Heater leads are normally brought out to the main terminal box. Heater voltage is available in two voltages for 50 Hz operation. Lead-time is 2 days.

Space Heaters - Explosion Proof - MOD41

Space heaters can be furnished on explosion proof motors. Heater leads are normally brought out to the motor conduit box. Heater voltage is available in three voltages for 60 Hz operation of 115, 230, or 460 volt, single-phase. Space heaters are sized per NEMA standards. Lead-time is 2 days.

Terminal Blocks - MOD0 (Mult. Symbol S4)

Conduit box mounted terminal blocks provide for a convenient termination of power leads. The terminal blocks are sized for the proper amperage and voltage of the motor. The Globetrotter® IEC motor has IEC terminal blocks as standard.

Terminal Block

Install terminal blocks in conduit box of NEMA motor with lead connection. Customer to advise on lead connection. Call for lead-time. Contact factory to verify capability.

Thermal Protection - MOD0, and MOD14 (Mult. Symbol S4)

Thermal protection are built in protective devices that prevent motor overheating. They work either by interrupting the power supply when the motor overheats or by incorporating a pilot device that opens the holding circuit of a magnetic starter or energizes an alarm bell or warning light.

Thermostats - All Motors - MOD14

Thermostats are mounted on the stator winding and are temperature-sensing only, with normally closed snap action contacts. These devices are installed on the end-turns of the motor winding. Their purpose is to activate a warning device or shut down the motor upon excessive winding temperatures. The standard arrangement is the addition of 2 or 3 thermostats to the winding end-turns, connected in series with the leads brought out to the main motor conduit box. Class I Groups C & D / Class II Groups F & G Explosion Proof motors have hermetically sealed thermostats as standard. Lead-time is 2 days.

Thermistors - All Motors - MOD14

Thermistors are small, non-linear resistance devices placed on the stator windings. As the critical temperature is reached, the resistance of the thermistor changes radically, causing operation of a control relay. The standard arrangement is Q-3 positive temperature coefficient (PTC) type on winding end-turns with leads brought out to the main motor conduit box. On IEC motors the leads are brought into a conduit adjacent to the main conduit box and includes a terminal block. As standard, 3 Texas Instrument thermistors are furnished, one per phase. Control Module is available. Lead-time is 2 days.

Thermocouples - Non XP Motors - MOD0

Thermocouples sense temperature and offer inherent protection against abnormal stall and running conditions. The standard arrangement is the addition of an iron constantan thermocouple to the winding end turns or bearing housing with leads brought out to the main motor conduit box. Customer must specify number, type, and location at time of order. Lead-time is 2 days.

Weatherproofing/Special Service MOD5, and MOD49 (Mult. Symbol S4)

Weatherproofing or special service provides additional protection to windings and mechanical parts as well as special greases or modifications per industry specifications such as NEMA, or IEEE. Call for lead-time.

Tropical Anti-Fungus Treatment - MOD5

Windings and mechanical parts coated with polyurethane for superior protection to resist tropical environments. Not available on brake motors. Lead-time is 2 days.

Hazardous Duty™ Service

Division 2 Hazardous Motors - MOD49

The Division 2 hazardous modification incorporates a new fan, fan guard, and nameplate on most TEFC motors. XRI®-SD and IEEE841 motors have Division 2 statement on the nameplate as standard. The nameplate will say "CSA Certified, Group I, Division 2, Groups A, B, C, and D, Temperature Code. (See chart below) Call for lead-time.

NEMA FRAME	SERVICE FACTOR	POWER SUPPLY	FREQUENCY RANGE	TEMP CODE
56-449T	1.0	SineWave	50-60Hz	T3
56-449T	1.0	PWM	3-120Hz	T2D
56-449T	1.15	SineWave	60Hz	T2B

MODIFICATIONS THROUGH MOD CENTRAL

Accessory Kits - Index

DESCRIPTION	PAGE NUMBER
Bases	
• Adjustable Motor Bases	204
• Transition Bases	204
Bearings	
• Ball Bearing Conversion Kits	201
• Roller Bearing Conversion Kits	201
Blower	
• Axial Blower Kits	201
Bracket	
• C-Face Kits - Dripproof	190
• C-Face Kits - NEMA Premium / Globetrotter Dripproof	190
• C-Face Kits - Totally Enclosed	191
• C-Face Kits - XRI® IEEE 841	192
• D-Flange Kits	192
• FF (B5) Flange (IEC D-Flange)	193
• FT (B14) Flange (IEC C-Face)	193
• Metric Flanges to Reduce Diameter	193
Brakes	
• Brake Kits - Single and Three Phase	194
• Brake Kits - Inverter Duty (Black Max® and Blue Max®)	194
• Double C-Face Coupler Brake	194
• Vertical Modification Kit	194
Capacitor Kits	
• Capacitor Mounting Kit	197
• Capacitor with Mounting Kit	197
• Oval Run Capacitors	197
• Capacitor Selection Guide	198
Conduit Box	
• Cast Iron Conduit Box Kits	199
Drip Covers	
• Motor Rainshield/Fan Canopy	199
• Drip Cover Kits (48-256T Frame)	199
Encoders, Cables, and Stub Shaft	
• Avtron - Black Max® / Blue Max®	202
• BEI - Black Max® / Blue Max®	202
• Dynapar - Black Max® / Blue Max®	202
• EPC - Black Max® / Blue Max®	202
• Northstar - Black Max® / Blue Max®	202
• Turck - Black Max® / Blue Max®	202
• Danaher Controls (Cable Kits)	202
• Encoder Stub Shaft Kit (XRI®-SD & XRI®-841,TEFC only)	202

Accessory Kits - Index

DESCRIPTION	PAGE NUMBER
Explosion Proof	
• Explosion Proof Conduit box	199
• Lead Exit Reducer	199
Grounding	
• AEGIS - Shaft Grounding Ring Kit	203
• Shaft Grounding Brush Kit	203
• Replacement Brush	203
Mounting	
• 48 Frame Lug Mount Kits	196
• Fedders Adapter Plate	197
• Fedders Mounting Kit	197
• Length Adapter Kit	197
• Resilient Base Latches	196
• Resilient Base (includes latches)	195
• Resilient Mounting Kit	195
• Resilient Ring Kit	195
• Rheem/Ruud Mounting Kit	197
• Rubber Mounting Hardware	196
• Split Mounting Rings	196
5K Motor Accessories	
• Base Plates	200
• Bearings	200
• C-Face Endsheids	200
• Capacitors	200
• imPower Signal Cord	200
• ODE Endsheids	200
• Square Flange Endsheids	200
• Start Mechanisms	200
• Switches	200
• Voltage Change Plug	200
• Pump Motor Rainshield Kit	200
Severe Duty Construction (Upgrade Kits)	
• Cast Iron Fan Cover and Conduit Box Kits	201
Shaft Kits	
• Blower Wheel Remover	198
• Brass Punch	199
• Encoder Stub Shaft Kit (XRI®-SD & XRI®-841, TEFC only)	202
• Shaft Adapter Sleeve	198
• Shaft Lock Device	198
• Tapered Fork	198
Switches	
• Toggle Switches	198
Terminal Block Kits	
• Terminal Block Kits - 182 to 449 Frames	193

Accessory Kits - Multiplier Symbol S4



Complete kits with hardware necessary for converting Marathon stock rigid base motors to "C-Face" mounting with rigid base.

Excludes Blue Chip® XRI® Dripproof stock motors, see below

C-Face Kits - Dripproof (Standard and EPAct Efficiency)

CAT. NO.	FRAME	KIT NO.	LIST PRICE	WHERE USED (Models Containing)	WEIGHT	FOOT NOTES
AG212	56	161L185AAG1	\$37	A 6203 bearing (5K Type, 30 Frame)	3	
A534	56	161L187BAG1	\$37	A 6203 bearing (5K Type, 40 Frame)	3	
A436	56-143T-145T	KIT 140TCDR-1	\$69	A 6205 (25mm) bearing	3	75
A535	143T-145T	161L187BCG1	\$69	A 6205 bearing (5K Type, 40 Frame)	3	75
A666	182T-184T	KIT 175691	\$102	TTDW, TBDW, or TCDW	14	75
A606	213T-215T	KIT 210TCDW	\$143	TTDW, TBDW, or TCDW	13	75
A612	254T-256T	KIT 250TCDX	\$165	TTDX	13	75
A610	284T-286T/TS	KIT 280TCDP	\$306	TTDP or TSTDP	30	
A287	284T-286T/TS	KIT 280TCDC	\$306	TTDC/N	38	
A1287	284T-286T/TS	KIT 280TCDC	\$306	TTDCA	45	
A613	324T-326T/TS	KIT 320TCDP	\$530	TTDC/P or TSTDC/P	43	
A216	364T-365T	KIT 360TCDS	\$673	TTDC/S	71	
A219	364TS-365TS	KIT 360TSCDS	\$673	TSTDC/S	62	
A222	404T-405T	KIT 400TCDS	\$736	TTDS	82	
A225	404TS-405TS	KIT 400TSCDS	\$736	TSTDS	89	
A228	444T-445T	KIT 440TCDS	\$1,408	TTDS	116	
A231	444TS-445TS	KIT 440TSCDS	\$1,408	TSTDS	119	
A293	447TS/449TS	KIT 440TSCDN	\$1,408	TSTDN	144	

C-Face Kits - XRI Blue Chip® NEMA Premium and Globetrotter Dripproof

CAT. NO.	FRAME	KIT NO.	LIST PRICE	WHERE USED (Models Containing)	WEIGHT	FOOT NOTES
A600	143T-145T	KIT 175181	\$69	U244, U245, U246, U265, U758, U759, and U760	5	75
A436	143T-145T	KIT 140TCDR-1	\$69	E927, E928, and E929	3	75
A160	182T-184T	KIT 180TCD-WD	\$102	TTDB (2,4 and 6 pole)	14	
A602	213T-215T	KIT 175066	\$143	U268, U269, U763, U764, U765, and U766	18	75
A161	213T-215T	KIT 210TCD-WD	\$143	TTDB (2,4 and 6 pole)	22	
A622	254T-256T	KIT 175067	\$165	U254, U255, U767, U768, U769, and U770	27	75
A162	254T-256T	KIT 250TCD2-WD	\$165	TTDCA (2 pole only)	32	
A163	254T-256T	KIT 250TCD-WD	\$165	TTDCA (4 and 6 pole only)	32	
A626	284T-286T	KIT 175058	\$306	U256, U257, U771, U772, U773, and U774	32	
A164	284TS-286TS	KIT 280TCD2-WD	\$306	TSTDCA (2 pole only)	38	
A165	284T-286T	KIT 280TCD-WD	\$306	TTDCA (4 and 6 pole only)	38	
A627	324T-326T	KIT 175059	\$530	U775, U776, U777, U778, U798 and U799	39	
A166	324TS-326TS	KIT 320TCD2-WD	\$530	TSTDCA (2 pole only)	45	
A167	324T-326T	KIT 320TCD-WD	\$530	TTDCA (4 and 6 pole only)	45	
A628	364T-365T	KIT 175060	\$673	U779, U782, U783, U784, U927, and U928	56	
A629	364T-365T	KIT 175601	\$673	U1779, U1782, U1783, U1784, U1927, and U1928	56	
A216	364T-365T	KIT 360TCDS	\$673	E921	71	
A168	364TS-365TS	KIT 360TCD2-WD	\$673	TSTDCB (2 pole only)	85	
A169	364T-365T	KIT 360TCD-WD	\$673	TTDCB (4 and 6 pole only)	85	
A222	404T-405T	KIT 400TCDS	\$736	E922, E923, U270, and U271	82	
A225	404TS-405TS	KIT 400TSCDS	\$736	U250 and U251	89	
A228	444T-445T	KIT 440TCDS	\$1,408	U272, U273, E924, E925 and E926	116	

KITS AND ACCESSORIES

All Kits Listed on This Page are Stock

Accessory Kits - Multiplier Symbol S4



Complete kits with hardware necessary for converting Marathon stock rigid base motors to "C-Face" mounting with rigid base. Includes Globetrotter, XRI (AS NOTED), and Severe Duty.

Excludes Blue Chip® XRI® IEEE-841 stock motors, available on the next page.

C-Face Kits - Totally Enclosed

CAT. NO.	FRAME	KIT NO.	LIST PRICE	WHERE USED (Models Containing)	WEIGHT	FOOT NOTES
A437	56	KIT 56CFR-1	\$37	A 6203 (17mm) bearing (standard frame)	3	
AG215	56	161L186AAG1	\$37	A 6203 bearing (5K Type, 30 Frame)	3	
A536	56	161L188BAG1	\$37	A 6203 bearing (5K Type, 40 Frame)	3	
A665	56	KIT 175076	\$37	Use on 56 frame XRI-NEMA Premium rolled steel models	5	
A438	56-143T-145T	KIT 140TCFR-1	\$69	A 6205 (25mm) bearing or TBFR, TCFR, TTTR, or TTFR	5	75
A537	140T	161L188BCG1	\$69	A 6205 bearing (5K Type, 40 Frame)	5	75
A603	143T	KIT 143TCFN	\$69	TTFN, TTTC, or TTTN	5	75,76
A642	140T	KIT 175077	\$69	Use on 140 frame XRI-NEMA Premium rolled steel models	5	75
A655	145T	KIT 145TCFN	\$69	TTFN, TTTC, or TTTN	5	75,76
A170	182T-184T	KIT 180TCF-WD	\$102	TTFBA (GLOBETROTTER)	14	75
A640	182T-184T	KIT 180TCN4.5	\$102	TTFN (Non-Std. 4-1/2" ak dim)	14	75
A641	182T-184T	KIT 180TCN8.5	\$102	TTFN (8-1/2" AK)	14	75
A643	182T-184T	KIT 175296	\$102	Use on model numbers 182/4TTFR4026 (8-1/2"AK)	14	75
A644	182T-184T	KIT 180CF8.5-1	\$102	TTTT/S, TCFL/R, TTFC/L/R/S or THTS (Standard 8-1/2" AK dim.)	14	75
A645	182T-184T	KIT 180CF4.5-1	\$102	TTFC (Not XRI)/L/R/S (Non-Std. 4-1/2" AK dim.)	14	75
A666	182T-184T	KIT 175691	\$102	TCFW, TBFW, TTFW	14	75
A171	213T-215T	KIT 210TCF-WD	\$143	TTFBA (GLOBETROTTER)	22	75
A204	213T-215T	KIT 210TCFL	\$143	TTFL/R or TBFL	17	75
A206	213T-215T	KIT 210TCFS	\$143	TTFC (Not XRI)/S, THFS, TTTS and THTS (except 213/5TTFC4075)	17	75
A609	213T-215T	KIT 210TCFW	\$143	TBFW, TTFW	17	75
A646	213T-215T	KIT 210TCN	\$143	TTFN	17	75
A652	213T-215T	KIT 175068	\$143	Use on models 213TTFC4076 and 215TTFC4076	17	75
A667	213T-215T	KIT 175844	\$143	XRI-NEMA Premium models containing TTFW1	17	75
A172	254T-256T	KIT 250TCF2-WD	\$165	TTFCA (2 pole only)(GLOBETROTTER)	32	75
A173	254T-256T	KIT 250TCF-WD	\$165	TTFCA (4 and 6 pole only)(GLOBETROTTER)	32	75
A209	254T-256T	KIT 250TCFL	\$165	TTFL, and THTL (254TTFL4076)	21	75
A1209	254T-256T	KIT 250TCFL-R	\$165	TTFL1 and THTL1 (current frame design) (254TTFL14076)	21	75
A284	254T-256T	KIT 250TCFNA	\$165	TTFNA, and THTNA	35	75
A239	254T-256T	KIT 250TCFPA	\$165	TTFPA, THTPA, and TSTFPA	35	75
A601	254T-256T	KIT 250TCFP	\$165	TTFC (Not XRI, or 254/6TTFC4076)	35	75
A653	254T-256T	KIT 175191	\$165	Use on model numbers 254TTFC4076 and 256TTFC4076	21	75
A174	284TS-286TS	KIT 280TCF2-WD	\$306	TSTFCA (2 pole only)(GLOBETROTTER)	38	
A611	284T-286T/TS	KIT 280TCFP	\$306	TTFC (Not XRI)/P, THFP, TSTFP or TSTFC (except 284/6TTFC4076)	31	
A615	284T-286T/TS	KIT 280TCFN	\$306	TTFN or TSTFN	52	
A617	284T-286T/TS	KIT 280TCFPA	\$306	TTFPA, THFPA, and TSTFPA	45	
A618	284T-286T/TS	KIT 280TCFNA	\$306	TTFNA, THFNA, or TSTFNA	55	
A654	284T-286T	KIT 175061	\$306	Use on model numbers 284TTFC4076 and 286TTFC4076	31	
A175	284T-286T	KIT 280TCF-WD	\$306	TTFC (4 and 6 pole)(GLOBETROTTER)	38	
A176	324TS-326TS	KIT 320TCF2-WD	\$530	TSTFCA (2 pole only)(GLOBETROTTER)	45	
A214	324T-326T/TS	KIT 320TCFS	\$530	TTFS, THFS, or TSTFS	90	
A614	324T-326T/TS	KIT 320TCFP	\$530	TTFC (Not XRI)/P, THFP, TSTFP or TSTFC	50	
A619	324T-326T/TS	KIT 320TCFPA	\$530	TTFPA, THFPA, AND TSTFPA	57	
A177	324T-326T	KIT 320TCF-WD	\$530	TTFCA (4 and 6 pole only) (GLOBETROTTER)	45	
A178	364TS-365TS	KIT 360TCF2-WD	\$673	TSTFCA (2 pole only)(GLOBETROTTER)	85	
A396	364TS-365TS	KIT 360TSCFSR	\$673	TSTFS or TSHFS	105	
A217	364T-365T	KIT 360TCFS	\$673	TTFC (Not XRI)	105	
A179	364T-365T	KIT 360TCF-WD	\$673	TTFCA (4 and 6 pole only)(GLOBETROTTER)	85	
A395	364T-365T	KIT 360TCFSR	\$673	TTFS or THFS	105	
A226	404TS-405TS	KIT 400TSCFS	\$736	TSTFS or TSHFS	125	
A424	404TS-405TS	KIT 400TCF2-WD	\$736	TSTFC (2 pole only)(GLOBETROTTER)	175	
A223	404T-405T	KIT 400TCFS	\$736	TTFS or THFS	125	
A425	404T-405T	KIT 400TCF-WD	\$736	TTFC (4 and 6 pole only)(GLOBETROTTER)	175	
A232	444TS-445TS	KIT 440TSCFS	\$1,408	TSTFS or TSHFS	105	
A426	444TS-445TS	KIT 444/5TCF2-WD	\$1,408	TSTFC (2 pole only)(GLOBETROTTER)	225	
A621	444TS-445TS	KIT 440TSCFN	\$1,408	TSTFN or TSHFN	200	
A229	444T-445T	KIT 440TCFS	\$1,408	TTFS or THFS	175	
A427	444T-445T	KIT 444/5TCF-WD	\$1,408	TTFC (4 and 6 pole only)(GLOBETROTTER)	225	
A620	444T-445T	KIT 440TCFN	\$1,408	TTFN or THFN	205	
A428	447/9TS	KIT 447/9TCF2-WD	\$1,408	TSTFC (2 pole only)(GLOBETROTTER)	250	
A624	447/9TS	KIT 449TSCFS-1	\$1,408	TSTFS (6313 bearing), 2-Pole	200	
A625	447/9TS	KIT 449TSCFS-2	\$1,408	TSTFS (6318 bearing) 4-, 6-, and 8-Pole	200	
A429	447/9T	KIT 447/9TCF-WD	\$1,408	TTFC (4 and 6 pole only)(GLOBETROTTER)	250	
A623	447/9T	KIT 449TCFS	\$1,408	TTFS or THFS with ball bearings	200	

KITS AND ACCESSORIES

All Kits Listed on This Page are Stock

Accessory Kits - Multiplier Symbol S4

Complete Kits with hardware and Inpro/Seal® necessary for converting Marathon stock IEEE-841 rigid base motors to "C-Face" mounting with rigid base.

C-Face Kits - Blue Chip® XRI® IEEE-841 Motors

CAT. NO.	FRAME	KIT NO.	LIST PRICE	WHERE USED (Models Containing)	WEIGHT	FOOT NOTES
A181	143T	KIT 143TCTN - 841	\$146	THTN	9	75,76
A262	145T	KIT 145TCTN - 841	\$146	THTN	9	75,76
A182	182T - 184T	KIT 180TCFS - 841	\$206	THTS or THFS	13	75
A183	213T - 215T	KIT 210TCFS - 841	\$278	THTS or THFS	16	75
A184	254T - 256T	KIT 250TCFNA - 841	\$318	THFNA	35	75
A185	284T - 286T	KIT 280TCFN - 841	\$596	THFN	52	
A186	284T - 286T	KIT 280TCFNA - 841	\$596	THFNA	52	
A187	324T - 326T	KIT 320TCFS - 841	\$978	THFS	89	
A188	364T - 365T	KIT 360TCFSR - 841	\$1,224	THFS	95	
A189	364TS - 365TS	KIT 360TSCFSR - 841	\$1,224	TSHFS	95	
A190	404T - 405T	KIT 400TCFS - 841	\$1,344	THFS	129	
A191	404TS-405TS	KIT 400TSCFS-841	\$1,344	TSHFS	118	
A192	444T - 445T	KIT 440TCFS - 841	\$1,869	THFS	175	
A193	444TS - 445TS	KIT 440TSCFS - 841	\$1,869	TSHFS	108	
A194	444T - 445T	KIT 440TCFN - 841	\$1,869	THFN	201	
A195	444TS - 445TS	KIT 440TSCFN - 841	\$1,869	TSHFN	199	

D-Flange Kits

Complete kits with hardware necessary for converting Marathon **stock rigid base** motors to D-Flange mounting with rigid base.

CAT. NO.	FRAME	ENCLOSURE	KIT NO.	LIST PRICE	WHERE USED (Models Containing)	WEIGHT	FOOT NOTES
A647	254T-256T	TEFC	KIT 250TDFPA	\$407	TTFPA	21	97
A648	254T-256T	TEFC	KIT 250TDFNA	\$407	TTFNA	15	97
A649	254T-256T	TEFC	KIT 649R	\$407	TTFP or TTFC (EPAAct)	39	97
A650	284T-286T/TS	DRIPPROOF	KIT 650R	\$715	TTDP, TTDC, TSTD or TSTDC	38	
A651	284T-286T/TS	TEFC	KIT 651R	\$715	TTFP, TTFC (EPAAct), TSTFP or TSTFC (EPAAct)	38	
A656	284T-286T	TEFC	KIT 280TDFNA	\$715	TTFNA	60	97
A658	324T-326T/TS	TEFC	KIT 320TDFS	\$808	TTFS, TSTFS	118	
A657	324T-326T	TEFC	KIT 320TDFPA	\$808	TTFPA or TSTFPA	83	97
A637	364T-365T	TEFC	KIT 360TDFC	\$954	TTFC (EPAAct)	121	

Complete kits with hardware necessary for converting Marathon **stock C-Face rigid base** motors to D-Flange mounting with rigid base.

CAT. NO.	FRAME	ENCLOSURE	KIT NO.	LIST PRICE	WHERE USED (Models Containing)	WEIGHT
A630	182TC-184TC	TEFC	KIT 180TDFR	\$160	TTFR	17
A631	284TC-286TC	TEFC	KIT 280TDFP	\$716	TTFP	15
A632	324TC-326TC	TEFC	KIT 320TDFP	\$876	TTFP	71
A634	405TC	TEFC	KIT 400TDFS	\$1,194	TTFS	149

All Kits Listed on This Page are Stock

Accessory Kits - Multiplier Symbol S4

IEC Mounting Kits

Complete kits with hardware necessary for converting Marathon IEC stock motors to B5 and B14 mountings.

Flange Mounting Kits For Aluminum Frame Motors Only

FRAME	POLE	FLANGE	CAT. NO.	KIT NO.	LIST PRICE	BOLT CIRCLE "mm"	WEIGHT
63	ALL	FF/B5	A569	KIT 635115	\$53	115	15
	ALL	FT/B14	A561	KIT 631475	\$48	75	
71	ALL	FF/B5	A570	KIT 715130	\$62	130	15
	ALL	FT/B14	A562	KIT 711485	\$53	85	
80	ALL	FF/B5	A571	KIT 805165	\$67	165	25
	ALL	FT/B14	A563	KIT 8014100	\$59	100	
90	ALL	FF/B5	A572	KIT 905165	\$71	165	25
	ALL	FT/B14	A564	KIT 9014115	\$65	115	

Flange Mounting Kits For Cast Iron Frame, NEMA Premium (IE3) Motors Only

FRAME	POLE	FLANGE	CAT. NO.	KIT NO.	LIST PRICE	BOLT CIRCLE "mm"	WEIGHT
100	ALL	FF/B5	A554A	KIT 175810	\$94	215	16
		FT/B14	A581A	KIT 175817	\$86	130	10
2 & 4		FF/B5	A555B	KIT 175827	\$101	215	33
		FT/B14	A582B	KIT 175832	\$94	130	13
112	6	FF/B5	A554A	KIT 175810	\$94	215	33
		FT/B14	A581A	KIT 175817	\$86	130	13
132	2	FF/B5	A550	KIT 175828	\$134	265	20
		FT/B14	A589	KIT 175833	\$125	165	16
4 & 6		FF/B5	A556A	KIT 175812	\$134	265	20
		FT/B14	A583A	KIT 175819	\$125	165	16
160	2	FF/B5	A551	KIT 175829	\$254	300	33
		FT/B14	A590	KIT 175834	\$265	215	30
4 & 6		FF/B5	A557	KIT 175990	\$254	300	33
		FT/B14	A584	KIT 175991	\$265	215	30
180	2	FF/B5	A552	KIT 175830	\$347	300	41
		4 & 6	A558	KIT 175890	\$347	300	41
200	2	FF/B5	A553	KIT 175831	\$411	350	61
		4 & 6	A559	KIT 175994	\$411	350	61
225	ALL	FF/B5	A580	KIT 175995	\$718	400	76
250	ALL	FF/B5	A594	KIT 175835	\$921	400	165
280	ALL	FF/B5	A596	KIT 175836	\$1,152	500	201
315	ALL	FF/B5	A598	KIT 175837	\$1,454	600	232

Terminal Block Kits

Terminal blocks provide for a convenient termination for power leads, and are sized for the proper amperage and voltage of the motor. These kits fit domestically produced NEMA TEFC, TENV, and ODP motors equipped with cast iron conduit boxes. **Available on 182 to 449 frames.**

CAT. NO.	FRAME	KIT NO.	LIST PRICE	WEIGHT
A1000	180-210	KIT 180-210 TERM BLK	\$101	2
A1001	250-320	KIT 250-320 TERM BLK	\$123	3
A1002	360	KIT 360 TERM BLK	\$168	5
A1003	405-445	KIT 400-445 TERM BLK	\$168	7
A1004	447/449	KIT 447/9 TERM BLK	\$243	10

All Kits Listed on This Page are Stock

SB300 - Prices and Specifications are subject to change without notice.

Flange Mounting Kits For Cast Iron Frame, EPM (IE2) Motors Only

FRAME	FLANGE	CAT. NO.	KIT NO.	LIST PRICE	BOLT CIRCLE "mm"	WEIGHT	STYLE LETTER*
100	FF/B5	A573	KIT 1005215	\$94	215	16	None
		A554	KIT 175984	\$94	215	16	A
112	FF/B5	A574	KIT 1125215	\$101	215	33	None
		A555	KIT 175986	\$101	215	33	A
132	FF/B5	A575	KIT 1325265	\$134	265	20	None
		A556	KIT 175988	\$134	265	20	A
160	FF/B5	A576	KIT 1605300	\$254	300	33	None
		A557	KIT 175990	\$254	300	33	A
180	FF/B5	A577	KIT 1805300	\$315	300	33	None
		A558	KIT 175890	\$347	300	41	A
200	FF/B5	A578	KIT 2005350	\$411	350	45	None
		A559	KIT 175994	\$411	350	61	A
225	FF/B5	A579	KIT 2255400	\$526	400	60	None
		A580	KIT 175995	\$718	400	76	A

** Style letter refers to the 8th position in the motor model number.
Ex: 132STFCA4526

Metric Flanges To Reduce Diameter For Aluminum Frame Motors Only

MOTOR FRAME	NEW FRAME DIA.	CAT. NO.	KIT NO.	KIT ONLY LIST PRICE	WEIGHT
63	56	A585	KIT 175900	\$44	5
71	63	A586	KIT 175901	\$50	5
80	71	A587	KIT 175902	\$56	8
90	80	A588	KIT 175903	\$59	8



Accessory Kits - Multiplier Symbol S4 (except as noted)

Brake Kits - Single and Three Phase Motors

Stearns Brake Kits

These kits include a brake mounted to an external cast aluminum fan guard. Designed for easy field installation on Marathon's Four-In-One motors, 56, 143 and 145 frames only.

Selection Chart
(Used to select brake size)

TORQUE RATING LB-FT	LIST PRICE	115/230 VOLT		208-230/460 VOLT		575 VOLT		WEIGHT ALL
		CAT. NO.	KIT NO.	CAT. NO.	KIT NO.	CAT. NO.	KIT NO.	
3	\$398	A306	KIT 3BRK1	A301	KIT 3BRK3	A297	KIT 3BRK3A	10
6	\$469	A307	KIT 6BRK1	A302	KIT 6BRK3	A298	KIT 6BRK3A	11
10	\$580	—	—	A303	KIT 10BRK	A299	KIT 10BRKA	10

MOTOR HP	BRAKEMOTOR SHAFT RPM		
	LB-FT @3600	LB-FT @1800	LB-FT @1200
1/4	—	—	3
1/3	—	3	3
1/2	3	3	3
3/4	3	6	6
1	3	6	6
1.5	6	10	10
2	6	10	—

Dings Brake Kits

These kits include a brake mounted to an external cast aluminum fan guard. Designed for easy field installation on Marathon's Four-In-One motors, 56, 143 and 145 frames only.

TORQUE RATING LB-FT	LIST PRICE	115/230 VOLT		208-230/460 VOLT		575 VOLT		WEIGHT ALL
		CAT. NO.	KIT NO.	CAT. NO.	KIT NO.	CAT. NO.	KIT NO.	
3	\$398	A1306	KIT BRK-3 115/230	A1301	KIT BRK-3 208-230/460	A1297	KIT BRK-3 575	3
6	\$469	A1307	KIT BRK-6 115/230	A1302	KIT BRK-6 208-230/460	A1298	KIT BRK-6 575	10
10	\$580	-	-	A1303	KIT BRK-10 208-230/460	A1299	KIT BRK-10 575	10

Inverter Duty, TENV Black Max® and Blue Max® Motors - Multiplier Symbol E3

For normal (140%) torque rating, do not apply on motors larger than 2 HP. Reduced braking torque and/or longer stopping times can result from applying an undersized brake on higher HP motors.

These brake kits fit on both Black Max® and Blue Max® TENV motors (See pages 175 and 177). These can also be used together with the Double C-Face SL56 encoder to make a closed loop inverter brake motor.

TORQUE RATING LB-FT	LIST PRICE	115/208-230 VOLT		208-230/460 VOLT		575 VOLT		WEIGHT ALL
		CAT. NO.	KIT NO.	CAT. NO.	KIT NO.	CAT. NO.	KIT NO.	
6	\$715	A317	KIT BM6BRK115	A312	KIT BM6BRK	A315	KIT BM6BRK575	7
10	\$868	A318	KIT BM10BRK115	A313	KIT BM10BRK	A316	KIT BM10BRK575	7

See page 220 for encoder kit for installation between motor and brake.

Vertical Modification Kit (Stearns 87000-series) - Multiplier Symbol E3

Includes required hardware to accommodate vertical-above or vertical-below mounting. 5HP (184) and larger.

CAT. NO.	KIT NO.	LIST PRICE	WEIGHT
A157	KIT VRT87BRK	\$420	3



Double C-Face Coupler Brakes

ENCLOSURE - NEMA 2, IP-23 208-230/460V				ENCLOSURE - NEMA 4, IP-54 208-230/460V				ENCLOSURE - NEMA 4X, IP-55 208-230/460V				
FOOT/ POUND RATING	CAT. NO.	KIT NO.	LIST PRICE	FOOT/ POUND RATING	CAT. NO.	KIT NO.	LIST PRICE	FOOT/ POUND RATING	CAT. NO.	KIT NO.	LIST PRICE	WEIGHT ALL
3 ft. lb.	A903	KIT 903	\$530	3 ft. lb.	A906	KIT 906	\$652	3 ft. lb.	A909	KIT 909	\$755	12
6 ft. lb.	A904	KIT 904	\$591	6 ft. lb.	A907	KIT 907	\$736	6 ft. lb.	A910	KIT 910	\$816	12
10 ft. lb.	A905	KIT 905	\$673	10 ft. lb.	A908	KIT 908	\$816	10 ft. lb.	A911	KIT 911	\$897	12

All Kits Listed on This Page are Stock

Accessory Kits - Multiplier Symbol S4



Resilient Base - (GE)

Includes base and latch straps.
For use with motors having 2 1/4" resilient rings.

NEMA 48 Frame, 2 1/4" Dia Rings

CAT. NO.	KIT NO.	LIST PRICE	SHELL LENGTH	FRAME SIZE	WEIGHT
AG109	161L113AAG1	\$31	5.16	32	5
AG110	161L113AAG2	\$31	5.41	33	5
AG111	161L113AAG3	\$31	5.79	35	5
AG112	161L113AAG4	\$31	6.22	36	5
AG113	161L113AAG5	\$31	6.62	37	5
AG114	161L113AAG6	\$31	7.22	38	5
AG115	161L113AAG9	\$31	7.75	39	5

NEMA 56 Frame, 2 1/4" Dia Rings

CAT. NO.	KIT NO.	LIST PRICE	SHELL LENGTH	FRAME SIZE	WEIGHT
AG125	161L113ADG1	\$31	5.41	33	5
AG127	161L113ADG3	\$31	6.22	36, 49	5
AG128	161L113ADG4	\$31	6.62	37, 46	5
AG129	161L113ADG5	\$31	7.22	38, 49	5
AG130	161L113ADG14	\$31	7.75	39, 49	5



Resilient Base - MEMC

Used to add a Resilient Base to models having Resilient Rings. Results in 3" shaft height. Kit includes: mounting base and 2 latch assemblies.

6 1/2" Dia Fan & Blower Replacement Motors

CAT. NO.	KIT NO.	LIST PRICE	SHELL LENGTH	FRAME SIZE	WEIGHT
AG125	161L113ADG1	\$31	P243, P245	42	5
AG127	161L113ADG3	\$31	P244, P246, P180	49	5
AG128	161L113ADG4	\$31	P184, P185	46	5

CAT. NO.	KIT NO.	LIST PRICE	RING TO RING DIMENSION	WEIGHT
A107	KIT 107-637	\$12	6.37"	2



Resilient Mounting Kit

Used to add a resilient base to models having hubs only. 3-1/2" shaft height. Kit includes: mounting base, 2 resilient rings, 2 latch assemblies, 2 end caps and a slinger.

CAT. NO.	KIT NO.	LIST PRICE	USED WITH CAT. NO.	BASE LENGTH	WEIGHT
A279	KIT 279	\$21	X500	8-5/8"	5
A280	KIT 280	\$21	X501, X511, X208	9-1/8"	5
A281	KIT 281	\$47	X507, X509	11-5/8"	5
A282	KIT 282	\$41	X503	10-5/8"	5
A283	KIT 283	\$41	X502, X207	9-5/8"	5
A308	KIT 308	\$44	X206	10-1/8"	5



Resilient Mount Kit

Fits 48 Frame motors with 2-1/2" diameter resilient rings. Available in 3 sizes to fit 9", 10" and 12" blowers.

CAT. NO.	KIT NO.	LIST PRICE	SIZE	WEIGHT
A240	KIT 240	\$40	9"	5
A241	KIT 241	\$60	12"	5
A242	KIT 242	\$49	10"	5

All Kits Listed on This Page are Stock

Accessory Kits - Multiplier Symbol S4

Split Mounting Rings

Used for adapting a 2-1/4" Resilient Mounting Ring to 2-1/2". Kit includes: 4 split rings.



CAT. NO.	KIT NO.	LIST PRICE	WEIGHT
A104	KIT 104	\$8	1

Resilient Ring Kit

Used to mount Resilient Rings onto Hubbed PSC Brackets. Kit includes: 2 rubber resilient rings and 4 split rings.



CAT. NO.	KIT NO.	LIST PRICE	WEIGHT	NOTES
A110	KIT 110	\$11	1	2-1/4" (48 frame)
A114	KIT 114	\$16	1	2-1/2" (56 frame)

Rubber Mounting Hardware

Used for mounting the resilient base to a resilient ring. Kit includes: 4 clamps, 2 screws, and 2 nuts.



CAT. NO.	KIT NO.	LIST PRICE	WEIGHT	NOTES
A112	KIT 112	\$10	1	56 Frame
A113	KIT 113	\$10	1	48 Frame
AG195	161L110AA1	\$10	1	2 1/2" dia; 30 or 40
A518	161L110AA4	\$10	1	2 1/2" dia; 40

48 Frame Lug Mounts Kits



A249
Single Strap,
Dual Slot
2" L, 1/4" & 3/4" W
\$35



A250
Double Strap,
Dual Slot
2" L, 1/4" & 3/4" W
\$35



A251
Double Strap,
Dual Slot
4" L, 1/4" & 3/4" W
\$35



A252
Single Strap,
Single Slot
2" L x 3/8" W
\$35



A253
Double Strap,
Single Slot
2" L x 3/8" W
\$35



A254
Double Wire,
Single Slot
2" L x 3/8" W
\$35

All Kits Listed on This Page are Stock

Accessory Kits - Multiplier Symbol S4

Length Adapter Kit



Used to convert Hubless motors to Resilient Ring mount. One adapter bracket can be mounted directly to original motor bracket and the other is mounted on the motor's thru-bolts and can be adjusted to desired length. Kit includes: 2 adapters, 2 resilient rings, 4 split rings, 2 resilient rings, 4 split rings, and the necessary nuts, screws, and washers.

CAT. NO.	KIT NO.	DESCRIPTION	LIST PRICE	WEIGHT
A111	KIT 111	Two Adapters	\$20	1

Rheem/Ruud Mounting Kit



Used to replace a Rheem/Ruud condenser fan motor where the original was held in place by four cables. Kit includes: prepunched plated steel plate, 4-8x32 nuts with washer fastened, 4-10x32 nuts with washers fastened and 4-1/4" sheet metal screws. Instructions included.

CAT. NO.	KIT NO.	LIST PRICE	WEIGHT
A259	Kit 259	\$25	2



Fedders Mounting Kit

Used in Fedders air conditioners.

CAT. NO.	KIT NO.	LIST PRICE	WEIGHT
A277	Kit 277	\$25	2

Fedders Adapter Plate

Used to match Fedders rectangular mounting stud pattern on 5-5/8" motors.

CAT. NO.	KIT NO.	LIST PRICE	WEIGHT
A278	KIT 278	\$13	3

Capacitor Mounting Kit



Used for mounting a capacitor on the frame of a Permanent Split Capacitor motors. Kit includes: mounting strap, mounting screws, and terminal protection boot. (4 screws are included - 2#10 screws and 2#8 screws). **Fits 10mfd. and smaller capacitors only.**

CAT. NO.	KIT NO.	LIST PRICE	WEIGHT
A100	KIT 100	\$8	2

Capacitor with Mounting Kit

Kit includes 370 volt capacitor, mounting strap, mounting screws and terminal protection boot.

CAT. NO.	KIT NO.	LIST PRICE	WEIGHT
A100	KIT 100	\$8	2

Oval Run Capacitors



CAT. NO.	KIT NO.	SIZE	LIST PRICE	WEIGHT
A371	KIT 370-3	3mfd/370v	\$9	2
A372	KIT 370-4	4mfd/370v	\$9	2
A373	KIT 370-5	5mfd/370v	\$9	2
A375	KIT 370-7.5	7.5mfd/370v	\$11	2
A376	KIT 370-10	10mfd/370v	\$11	2
A378	KIT 370-15	15mfd/370v	\$19	2
A379	KIT 370-17.5	17.5mfd/370v	\$19	2
A380	KIT 370-20	20mfd/370v	\$21	2
A381	KIT 370-25	25mfd/370v	\$24	2
A382	KIT 370-30	30mfd/370v	\$27	2
A445	KIT 440-7.5	7.5mfd/440v	\$17	2
A446	KIT 440-10	10mfd/440v	\$19	2
A965	111A271P113	208mfd/110V	\$12	2

All Kits Listed on This Page are Stock

Accessory Kits - Multiplier Symbol S4

Capacitor Selection Guide for Stock PSC Motors

370 VOLT											440 VOLT						
3.0 mfd	4.0 mfd	5.0 mfd					7.5 mfd	10.0 mfd	15.0 mfd	17.5 mfd	20.0 mfd	25.0 mfd	30.0 mfd	7.5 mfd	10.0 mfd		
X411	X223	X001	X048	X069	X210	X417	X000	X294	X004	X453	X009	X433	X206	X462	X271	X454	X237
X427	X273	X003	X049	X070	X212	X418	X002	X413	X010	X458	X016		X447	X449	X448	X446	X241
X429	X281	X006	X050	X080	X215	X419	X005	X415	X021	X1010	X023		X242		X405		
		X011	X052	X081	X216	X420	X013	X422	X033		X027						
		X012	X056	X082	X217	X423	X015	X424	X035		X036						
		X014	X057	X083	X219	X428	X018	X426	X038		X039						
		X017	X058	X086	X233	X430	X020	X450	X063		X085						
		X019	X059	X087	X234	X440	X022	X456	X068		X090						
		X034	X060	X088	X236	X441	X037	X457	X084		X099						
		X040	X061	X089	X258	X442	X071	X465	X096		X205						
		X041	X062	X097	X278	X443	X203		X098		X207						
		X042	X064	X200	X287	X445	X213		X208		X218						
		X043	X065	X202	X295	X463	X214		X211		X298						
		X044	X066	X204	X297	X464	X222		X221		X444						
		X045	X067	X209	X412	X262	X225		X400		X452						
		X033	X470				X231		X414		X455						
							X283		X416		X459						
									X451								

Shaft Adapter Sleeve



Used to increase the diameter of a shaft to a larger size. Available sizes include converting from a 1/2" dia. shaft with flat to a 5/8" dia. with key and from a 5/8" dia. with key to a 3/4" dia. with key. Kit includes adapter sleeve and key.

CAT. NO.	KIT NO.	TO CHANGE SHAFT	LIST PRICE	WEIGHT
A105	KIT 105	1/2" to 5/8"	\$8	3
A106	KIT 106	5/8" to 3/4"	\$11	3

Shaft Lock Device



Used as a pry point for prying the blade off. Instructions included.

CAT. NO.	KIT NO.	LIST PRICE	WEIGHT
A257	KIT 257	\$47	2

Blower Wheel Remover



Used to pull off corroded, rusted, stubborn blower wheels from 5/8" diameter shafts and smaller. Comes with complete instructions.

CAT. NO.	KIT NO.	LIST PRICE	WEIGHT
A256	KIT 256	\$148	2

Tapered Fork



Used for prying off pulleys, fan blades, etc., from any shaft 5/8" diameter or smaller. Long 16" handle gives good leverage. Instructions included.

CAT. NO.	KIT NO.	LIST PRICE	WEIGHT
A258	KIT 258	\$62	4

Toggle Switch



Start switches for single-phase open dripproof motors only in ratings one horsepower and smaller. Switch is mounted on the motor terminal box cover.

CAT. NO.	KIT NO.	LIST PRICE	WEIGHT	NO. OF POLES	FRAME SIZE
AG228	112A515AKG4	\$37	2	Single (SPST)	30
AG229	112A515ASG2	\$37	2	Single (SPST)	40

All Kits Listed on This Page are Stock

Accessory Kits - Multiplier Symbol S4 (except as noted)

Brass Punch



Used for placing between your hammer and a motor's shaft or bearing. 3/4" diameter x 6" length.

CAT. NO.	KIT NO.	LIST PRICE	WEIGHT
A261	KIT 261	\$21	6

Motor Rainshield/Fan Canopy

Sizes to fit 1/2" or 5/8" diameter shafts. 6.88" diameter. Shield has 8 air vanes to provide air circulation for motor. For vertical shaft up applications. Rain shield mounts over shaft.

056 Type Model Numbers



CAT. NO.	KIT NO.	LIST PRICE	WEIGHT	SHAFT DIA.
A247	KIT 247	\$8	2	1/2"
A248	KIT 248	\$8	2	5/8"

5K Type Model Numbers Includes clamp and black plastic cover.



CAT. NO.	KIT NO.	LIST PRICE	WEIGHT	WHERE USED
A549	52A101229AAG1	\$57	2	5.5" Dia. Motors, 1/2" shaft dia.

Drip Cover Kits

Mounts with two screws into the end bracket. Kit includes: drip cover, mounting screws, washers, and instructions. Contact Marathon Electric to determine compatibility with motor. For vertical shaft down applications.

Note: Kit 234, the mounting holes have a 4.80 bolt circle.

CAT. NO.	FRAME	KIT NO.	ENCLOSURE	LIST PRICE	WEIGHT
A234	48-184T("629")	KIT 234	ODP OR TEFC	\$24	2
AG234	48-56	161L528AAG1	5K MDLS ODP	\$24	2
A201	182T-184T	KIT 201	ODP	\$27	3
A662	182T-184T	KIT 175614	ODP (TTDW)	\$62	15
A197	182T-184T	KIT 197	TEFC (4-IN-1)	\$27	3
A202	213T-215T	KIT 202	ODP (TTDR)	\$31	5
A198	213T-215T	KIT 198	ODP (TTDW)	\$31	5
A199	213T-215T	KIT 199	TEFC (4-IN-1)	\$31	5
A311	254T-256T	KIT 311	ODP (TTDX) Rigid Base	\$31	8

Conduit Box Kit (56/140 Frame Explosion Proof Motors)

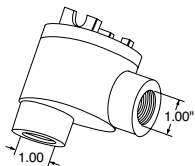

For installation on rolled steel 56/140 frame explosion proof motors. Lead exit holes are 1" dia. NPT.

CAT. NO.	KIT NO.	LIST PRICE	WEIGHT
A800	KIT 56 EXPR BOX	\$93	2

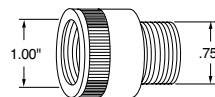

Lead Exit Reducers (56/140 Frame Explosion Proof Motors)

For reducing the lead exit from 1" to 3/4". Kit LDRDCR-M has an externally threaded 3/4" exit and internally threaded 1" exit.

CAT. NO.	KIT NO.	LIST PRICE	WEIGHT
A803	KIT LDRDCR-M	\$17	2

Cast Iron Conduit Box Kits

Fits standard Blue Chip® motors. Threaded conduit box and gaskets.

CAT. NO.	FRAME	KIT NO.	LIST PRICE	WEIGHT
A720	182-215T	KIT 180/210CB	\$80	4
A722	254T-256T	KIT 250CB	\$132	12
A729	284T/TS-286T/TS	KIT 280CB	\$178	12
A730	324T/TS-326T/TS	KIT 320CB	\$198	28
A119	364T/TS-445T/TS	KIT 364-445CB	\$333	34

All Kits Listed on This Page are Stock

Accessory Kits - Multiplier Symbol S4

5K Motor Accessories



CAT. NO.	KIT NO.	DISCRIPTION	LIST PRICE	WEIGHT
A000	KIT 391-200-01	15' Single cable kit	\$38	3
A940	KIT 391-200-02	25' Single cable kit	\$50	4
A940	52D310833AAP001	30 Frame C-face PE Endshield	\$21	4
A941	52D311808ARP1	40 Frame C-face PE Endshield	\$39	4
A942	52D310814AAP1	30 Frame OPE Endshield	\$15	4
A945	115D964P1	Base Plate for 30 Frame	\$8	2
A946	115D964P2	Base Plate for 40 Frame	\$8	2
A947	115D963P1	Back Compartment Cover	\$8	2
A948	113A617AG001	OPE bearing 17 mm	\$9	3
A949	113A620AYP1	PE bearing 20 mm	\$21	2
A950	976B399AAP9	Run Capacitor 15mfd/370v	\$24	2
A951	976B399AAP12	Run Capacitor 22.5mfd/370v	\$28	2
A952	976B399AAP13	Run Capacitor 25mfd/370v	\$29	2
A953	976B399ABP6	Run Capacitor 40mfd/370v	\$39	2
A954	976B399ABP9	Run Capacitor 45mfd/370v	\$35	2
A955	976B399ABP10	Run Capacitor 50mfd/370v	\$29	2
A956	161L198AAG9	Switch for Single Speed Models	\$9	1
A957	161L198AAG10	Switch for Two Speed Models	\$17	2
A958	161L197ABG1	Start mech for Single Speed Models	\$4	1
A959	161L197ABG11	Start mech for Two Speed Models	\$8	1
A960A	3062.09	Start Capacitor 161-193mfd/110v	\$12	2
A961	111A271P111	Start Capacitor 40mfd/220v	\$12	2
A962	52D310822ACDP1	30 Frame Square Flange PE Endshield	\$20	4
A963	52D311819ABP1	40 Frame Square Flange PE Endshield	\$39	4
A964	52A103486G1	Voltage Changing Plug	\$3	2

Pump Motors Rainshield Kit

Designed for horizontally mounted pump motors to adhere to UL1081 standard. Includes screw and rain cover.



CAT. NO.	KIT NO.	WHERE USED	LIST PRICE	WEIGHT
AG697	161L210AAP1	5" & 5 1/2" Dia. Motors	\$57	1

All Kits Listed on This Page are Stock

Accessory Kits - Multiplier Symbol S4

Severe Duty - Upgrade to Cast Iron Fan Cover / Conduit Box

Fits standard Blue Chip® motors to achieve all cast iron construction.
Components include fan guard and threaded conduit box.

CAT. NO.	KIT NO.	LIST PRICE	FRAME	WEIGHT	WHERE USED
A715	KIT 140CB	\$110	143T-145T	4	TTTN
A718	KIT 180R	\$158	182T-184T	17	TTTS, TTFS, TTFC, THTS
A721	KIT 210R	\$230	213T-215T	19	TTFS, TTTS, THTS, TTFC
A723	KIT 250RFPA	\$279	254T-256T	32	TTFPA, or THFPA
A724	KIT 250RFNA	\$279	254T-256T	34	TTFNA, TTFCA, THTNA, or THFNA
A725	KIT 250R	\$279	254T-256T	32	TTFC
A726	KIT 280RFPA	\$388	284T-286T	34	TTFPA, TSTFPA, or TSHFPA
A727	KIT 280RFN	\$388	284T-286T	39	TTFN or TSTFN
A728	KIT 280R	\$388	284T-286T	39	TTFC or TTFP
A731	KIT 280RFNA	\$388	284T-286T	32	TTFNA, TSTFNA, THFNA or TSHFNA
A733	KIT 320RFPA	\$411	324T-326T	55	TTFPA, TSTFPA, THFPA, or TSHFPA

Ball Bearing Conversion Kits

For conversion of Roller Bearing on Drive End to Ball Bearing (for Direct-coupled applications).

CONFIRM KIT SELECTION WITH CUSTOMER SERVICE/ENGINEERING

CAT. NO.	KIT NO.	LIST PRICE	FRAME	BEARING SIZE	ENCLOSURE	WEIGHT	WHERE USED (Models Containing)
A760	KIT 440BBFN	\$1,530	444T-445T	318	TEFC	160	TTFN, THFN
A761	KIT 449BBFS	\$1,592	447T-449T	319	TEFC	171	TTFS, THFS
A788	KIT 449BBFS-319	\$1,592	L447T-L449T	319	TEFC	174	TTFS
A787	KIT 449BBFS-322	\$1,592	447T-449T	322	TEFC	196	TTFS
A795	KIT L449BBFS-322	\$1,592	L447T-L449T	322	TEFC	190	TTFS

Roller Bearing Conversion Kits

For conversion of Ball Bearing on Drive End to Roller Bearing (for Belted Applications).

CONFIRM KIT SELECTION WITH CUSTOMER SERVICE/ENGINEERING

CAT. NO.	KIT NO.	LIST PRICE	FRAME	ENCLOSURE	WEIGHT	WHERE USED (Models Containing)
A755	KIT 360BRFSR-314	\$1,164	364T-365T	TEFC	14	TTFS, THFS
A756	KIT 400BRFS-316	\$1,164	404T-405T	TEFC	19	TTFS, THFS
A757	KIT 440BRFS-318	\$1,530	444T-445T	TEFC	32	TTFS, THFS
A759	KIT 440BRFN	\$1,530	444T-445T	TEFC	13	TTFN, THFN
A758	KIT 449BRFS	\$1,592	447T-449T	TEFC	20	TTFS, THFS

Axial Blower Kits

For installation on Blue Chip XRI® Totally Enclosed and Severe Duty (excluding Explosion Proof).

CAT. NO.	KIT NO.	LIST PRICE	FRAME	WEIGHT	WHERE USED (Models Containing)
A692	KIT 21TEBC	\$1,606	213T-215T	104	TTFS
A691	KIT 25TEBCNA	\$1,755	254T-256T	158	TTFNA (Also fits 284/286T/TS TTFPA)
A701	KIT 28TEBCNA	\$2,066	284T/TS-286T/TS	103	TTFNA
A695	KIT 32TEBC	\$2,430	324T/TS-326T/TS	200	TTFS
A696	KIT 36TEBC	\$3,112	364T/TS-365T/TS	172	TTFS
A697	KIT 40TEBC	\$3,661	404T/TS-405T/TS	242	TTFS
A698	KIT 44TEBC-313	\$4,081	444TS-449TS	401	A 6313 bearing on opposite shaft end
A699	KIT 44TEBC-316	\$4,081	444T-449T	401	A 6316 bearing on opposite shaft end (excludes roller bearing)
A700	KIT 44TEBC-318	\$4,081	444T-449T	401	A 6318 bearing on opposite shaft end (excludes roller bearing)
A796	KIT L449TEBC	\$4,081	L447T-L449T	272	With L447/449 Frames

All Kits Listed on This Page are Stock

Accessory Kits - Multiplier Symbol E3

Encoder Kits and Accessories for Black Max, Blue Max, XRI-SD and XRI-841 motors

Installation of encoder kits on Blue Chip XRI-SD and XRI-841 TEFC motors requires installation of A807 Stub Shaft Kit (see below)

ENCL.	FRAME	BRAND/ MODEL	PPR	CAT. NO.	KIT MO.	LIST PRICE	WEIGHT	NOTES		
TENV (5/8" bore)	56-286	Avtron HS25A	1024 2048	A746 A747	KIT HS25A1024-NV KIT HS25A2048-NV	\$1,064	4 4	Shaft Mount, 5-26 VDC, with 10 pin connector/mate		
		Avtron HS35A	1024 2048	A736 A779A A739	KIT HS35A1024-NV KIT HS35A/B1024-NV KIT HS35A2048-NV	\$1,446	4 4 4	Shaft Mount, 5-26 VDC, with 10 pin connector/mate		
				A780A	KIT HS35A/B2048-NV			Shaft Mount, 5-26 VDC, with 10 pin connector/mate (REPLACES BEI A779)		
								Shaft Mount, 5-26 VDC, with 10 pin connector/mate (REPLACES BEI A780)		
		Avtron HS35M	1024	A742	KIT HS35M1024	\$1,674	4	Shaft Mount, 5-24 VDC, with EPIC connector/mate		
		Avtron M3	1024	A753	KIT M31024-NV	\$2,800	10	Shaft Mount, 5-24 VDC, with EPIC connector/mate		
		Avtron AV56	1024	A793	KIT M561024-NV	\$2,283	5	Modular Mount, 5-24 VDC, with EPIC connector/mate, Double C-Face		
		BEI HS35	1024 2048	A779 A780	KIT HS35B1024-NV KIT HS35B2048-NV	\$1,446	3 3	Shaft Mount, 5-28 VDC, with 10 pin connector/mate (To Be Discontinued)		
		Dynapar HS20	1024	A687	KIT HS201024-NV	\$672	3	Shaft Mount, 5-26 VDC, with 10 pin connector/mate		
		Dynapar HS35R	1024 2048	A772 A776	KIT HS351024-NV KIT HS352048-NV	\$1,446	3 3	Shaft Mount, 5-26 VDC, with 10 pin connector/mate		
		EPC 260	2048	A686	KIT EPC260 2048	\$672	3	Shaft Mount, 5-16 VDC, with M12 Connector (To Be Discontinued)		
		NorthStar HSD35	1024	A711	KIT HSD351024-NV	\$1,562	4	Shaft Mount, 5-26 VDC, with EPIC connector/mate		
		NorthStar SL56	1024	A785 A763 A786	KIT LKSR512 KIT LKSR02 KIT LKSR-CFACE	\$2,283 \$2,283 \$2,510	5 5 5	Modular Mount, 5-15 VDC, with EPIC connector/mate		
				Modular Mount, 5-15 VDC, with EPIC connector/mate						
				Modular Mount, 5-15 VDC, with EPIC connector/mate, Double C-Face						
TEFC (1" bore)	182-449	Avtron HS35A	1024 2048	A737 A783A A740	KIT HS35A1024-FC KIT HS35A/B1024-FC KIT HS35A2048-FC	\$1,446	4 4 4	Shaft Mount, 5-26 VDC, with 10 pin connector/mate		
				A784A	KIT HS35A/B2048-FC			Shaft Mount, 5-26 VDC, with 10 pin connector/mate (REPLACE BEI A783)		
				A742	KIT HS35M1024			Shaft Mount, 5-26 VDC, with 10 pin connector/mate (REPLACE BEI A784)		
		Avtron HS35M	1024	A742	KIT HS35M1024	\$1,674	4	Shaft Mount, 5-24 VDC, with EPIC connector/mate		
		Avtron M3	1024	A754	KIT M31024-FC	\$2,800	10	Shaft Mount, 5-24 VDC, with EPIC connector/mate		
		BEI HS35	1024 2048	A783 A784	KIT HS35B1024-FC KIT HS35B2048-FC	\$1,446	3 3	Shaft Mount, 5-28 VDC, with 10 pin connector/mate (To Be Discontinued)		
		Dynapar HS35R	1024 2048	A774 A777	KIT HS351024-FC KIT HS352048-FC	\$1,446	3 3	Shaft Mount, 5-26 VDC, with 10 pin connector/mate		
		NorthStar HSD35	1024	A712	KIT HSD351024-FC	\$1,562	4	Shaft Mount, 5-26 VDC, with EPIC connector/mate		
		Avtron HS35A	1024	A738	KIT HS35A1024-BC	\$1,446	3	Shaft Mount, 5-26 VDC		
		Avtron AV56	1024	A794	KIT M561024-BC	\$2,283	4	Shaft Mount, 5-24 VDC		
		BEI HS35	1024 2048	A781 A782	KIT HS35B1024-BC KIT HS35B2048-BC	\$1,446	3 3	Shaft Mount, 5-28 VDC, (To Be Discontinued)		
		Dynapar HSD38	1024 2048	A775 A778	KIT HS351024-BC KIT HS352048-BC	\$1,446	3 3	Shaft Mount, 5-26 VDC		
NorthStar SL56	1024	A764	KIT LKSR03	\$2,283	5	Modular Mount, 5-15 VDC				
Turck A02H	1024 2048	A668 A669	KIT A02H1024-BC LED KIT A02H2048-BC LED	\$1,624	4 4	Shaft Mount, 5-30VDC, bulkhead (A801 not required), LED cordset (3m)				
ALL		A801	KIT ENCBOX	\$152	2	Encoder Conduit Box (required for all TEBC encoders except Turck A02H)				
TENV BRAKE- MOTORS	143-256	Avtron AV56	1024	A748 A749	KIT M561024BRK-140 KIT M561024BRK-182	\$2,283	4 4	Fits Blue Max Brakemotors (Y986, Y987)		
				A750	KIT M851024BRK-184			Fits Blue Max Brakemotors (Y989)		
				A751	KIT M851024BRK-210			Fits Blue Max Brakemotors (Y990, Y991)		
		NorthStar SL56	1024	A752 A786	KIT M851024BRK-250 KIT LKSR-CFACE	\$2,510	5 5	Fits Blue Max Brakemotors (Y992, Y993)		
				A789	KIT SL561024-182NV			Fits Blue Max Brakemotors (Y986, Y987)		
		NorthStar SL85	1024	A790 A791 A792	KIT SL851024-184NV KIT SL851024-210NV KIT SL851024-250NV	\$3,080	8 8 8	Fits Blue Max Brakemotors (Y988)		
								Fits Blue Max Brakemotors (Y989)		
								Fits Blue Max Brakemotors (Y990, Y991)		
		CABLE KITS	56-449	Danaher Controls	N/A	A688-10	KIT A688-10	\$279	3	10' cable and pre-wired 10-pin connector for all 10 pin (MS) connectors
					N/A	A688-20	KIT A688-20	\$393	3	20' cable and pre-wired 10-pin connector for all 10 pin (MS) connectors
					N/A	A688-25	KIT A688-25	\$446	4	25' cable and pre-wired 10-pin connector for all 10 pin (MS) connectors
					N/A	A688-30	KIT A688-30	\$502	4	30' cable and pre-wired 10-pin connector for all 10 pin (MS) connectors
					N/A	A688-50	KIT A688-50	\$725	5	50' cable and pre-wired 10-pin connector for all 10 pin (MS) connectors
					N/A	A688-60	KIT A688-60	\$836	5	60' cable and pre-wired 10-pin connector for all 10 pin (MS) connectors
		N/A	A688-100	KIT A688-100	\$1,280	10	100' cable and pre-wired 10-pin connector for all 10 pin (MS) connectors			
N/A	A690-15	KIT A690-15	\$231	3	15 feet bulk cable, for use with NorthStar encoders					

Encoder Stub Shaft Kit

Fits XRI® Severe Duty or XRI® IEEE-841 motors to allow the addition of 1" bore hollow shaft encoders on opposite drive end of motor.

CAT. NO.	KIT NO.	LIST PRICE	FRAME	WEIGHT	WHERE USED
A807	KIT STUBSHAFT 1IN	\$168	182T-449T/TS	3	FAN COOLED SEVERE DUTY AND IEEE-841

All Kits Listed on This Page are Stock

Accessory Kits - Multiplier Symbol E3

Shaft Grounding Kits



Shaft Grounding:

Shaft grounding is recommended (NEMA MG1 31.4.4.3) as an effective means of bearing protection for motors operated from inverter power. One grounding device is adequate to bleed down inverter-sourced shaft voltages, thereby protecting both bearings for motors as large as 6085 frame.

SGR Kit:

Kit includes grounding ring, adhesive mounting hardware and instructions (for domestic products only).

SGR Universal Kit:

Kit includes grounding ring, all mounting hardware needed to mount to any standard drive end bracket and instructions.

Shaft ground rings fit these NEMA shaft extension frames listed below, they are designed to mount on the shaft end. For larger frames, please contact Marathon Electric.

SGR Kit

FRAME	SGR KIT NO.	SGR CAT. NO.	LIST PRICE	WEIGHT
48	KIT SGR-11.2	A500-5	\$218	2
56	KIT SGR-14.4	A500-8	\$218	1
143-145T	KIT SGR-20.7	A500-14	\$232	2
182-184T	KIT SGR-27.1	A500-20	\$252	1
213-215T	KIT SGR-33.4	A500-26	\$284	1
254-256T	KIT SGR-39.8	A500-32	\$351	1
284-286T	KIT SGR-46.1	A500-38	\$419	1
284-286TS	KIT SGR-39.8	A500-32	\$351	1
324-326T	KIT SGR-52.5	A500-44	\$485	1
324-326TS	KIT SGR-46.1	A500-38	\$419	1
364-365T	KIT SGR-58.8	A500-50	\$551	1
364-365TS	KIT SGR-46.1	A500-38	\$419	1
404-405T	KIT SGR-71.5	A500-62	\$815	1
404-405TS	KIT SGR-52.5	A500-44	\$485	1
444-445T	KIT SGR-84.2	A500-74	\$1,168	1
444-445TS	KIT SGR-58.8	A500-50	\$551	1
447/449T	KIT SGR-84.2	A500-74	\$1,168	1
447/449TS	KIT SGR-58.8	A500-50	\$551	1
5000LS	KIT SGR-71.5	A500-62	\$815	1

SGR Universal Kit

SGR KIT NO.	SGR UKIT CAT. NO.	LIST PRICE	WEIGHT
---	---	---	---
KIT SGR-0.625-UK	A499-1	\$338	5
KIT SGR-0.875-UK	A499-2	\$365	5
KIT SGR-1.125-UK	A499-3	\$391	5
KIT SGR-1.375-UK	A499-4	\$417	5
KIT SGR-1.625-UK	A499-5	\$522	5
KIT SGR-1.875-UK	A499-6	\$574	5
KIT SGR-1.625-UK	A499-5	\$522	5
KIT SGR-2.125-UK	A499-7	\$653	7
KIT SGR-1.875-UK	A499-6	\$574	5
KIT SGR-2.375-UK	A499-8	\$706	7
KIT SGR-1.875-UK	A499-6	\$574	5
KIT SGR-2.875-UK	A499-9	\$915	7
KIT SGR-2.125-UK	A499-7	\$653	7
KIT SGR-3.375-UK	A499-10	\$1,230	7
KIT SGR-2.375-UK	A499-8	\$706	7
KIT SGR-3.375-UK	A499-10	\$1,230	7
KIT SGR-2.375-UK	A499-8	\$706	7
---	---	---	---

Conductive Epoxy:

Epoxy comes in two 7g syringes, 14g (0.35 oz). This two part epoxy offers high electrical conductivity and strong conductive bonding. Use in place of traditional end bracket drilling.

CAT. NO.	KIT NO.	LIST PRICE	WEIGHT
A496	EP2400	511	2

Replacement ground brush mounting hardware and brushes

CAT. NO.	KIT NO.	LIST PRICE	WEIGHT	COMMENTS
A103	KIT 103	\$349	1	Drive end mount
A116	KIT 116	\$504	1	Non-drive end mount
A109	KIT 109	\$55	1	Replacement Brush

⚠ WARNING: Grounding devices may not be installed on motors used in Division 1 or Division 2 hazardous locations.

All Kits Listed on This Page are Stock

Accessory Kits - Multiplier Symbol S4

Transition Bases

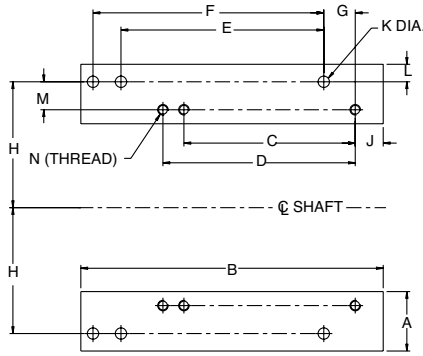

Application:

Convert "T" frame ratings to "U" frame based dimensions and shaft heights. Shaft dimensions may vary from actual "U" frame specifications.

Dimensions = Inches

CAT. NO.	KIT NO.	CONVERTS		A	B	HGT	C	D	E	F	G	H	J	K	L	M	N (THREAD)	APP. WGHT.	LIST PRICE
		FROM	TO																
1814T	KIT 180U	143/5T	182/4	2 1/4	7 1/2	1	4	5	4 1/2	5 1/2	1/2	3 3/4	1	7/16	1/2	1	5/16-18	2	\$147
2118T	KIT 210U	182/4T	213/5	1 3/4	9 1/2	3/4	4 1/2	5 1/2	5 1/2	7	1	4 1/4	1	7/16	7/16	1/2	3/8-16	3	\$186
25U21T	KIT 250U	213/5T	254/6U	2 7/16	12 3/4	1	5 1/2	7	8 1/4	10	1 1/8	5	1	9/16	5/8	3/4	3/8-16	5	\$186
28U25T	KIT 280U	254/6T	284/6U	2 3/4	14 1/4	3/4	8 1/4	10	9 1/2	11	1 3/8	5 1/2	1 1/4	9/16	15/16	1/2	1/2-13	8	\$186
32U28T	KIT 320U	284/6T	324/6U	3 1/4	15 3/4	1	9 1/2	11	10 1/2	12	1 1/2	6 1/4	1 1/2	11/16	15/16	3/4	1/2-13	10	\$220
36U32T	KIT 360U	324/6T	364/5U	3 11/16	16 1/2	1	10 1/2	12	11 1/4	12 1/4	1 3/4	7	1 3/4	11/16	1 3/16	3/4	5/8-11	13	\$260
40U36T	KIT 400U	364/5T	404/5U	4 1/4	18 5/8	1	11 1/4	12 1/4	12 1/4	13 3/4	2	8	2	13/16	1 1/4	1	5/8-11	22	\$333
44U40T	KIT 440U	404/5T	444/5U	4 1/4	21 5/8	1	12 1/4	13 3/4	14 1/2	16 1/2	2 1/4	9	2	13/16	1 1/4	1	3/4-10	24	\$333

Adjustable Motor Bases (Slide Bases)

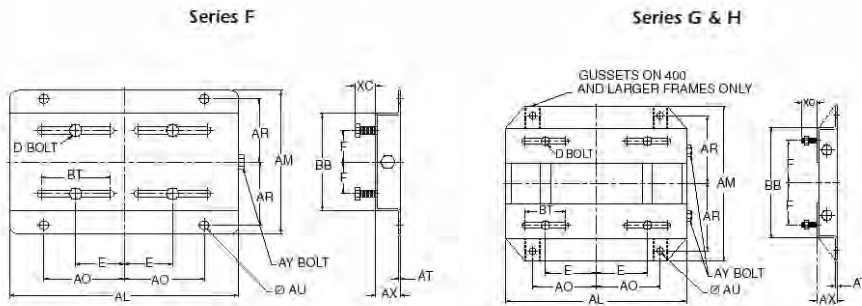

Application:

Used to adjust tension during motor installation. Made with heavy duty steel construction with single screw adjustment for 143T-215T Frame and double screw adjustment for 254T Frame and larger.

Dimensions = Inches

SERIES	FRAME	CAT. NO.	KIT NO.	AL	AM	AX	BB	E	F	AO	AR	AU	BT	AT	XC	D BOLT	AY BOLT	WGHT. LBS.	LIST PRICE
F	143	143A	KIT 143SB	10 1/2	7 1/2	1 1/8	5 1/2	2 3/4	2	3 3/4	3 3/8	3/8	3	0.119	13/16	5/16 x1	3/8x4	5	\$90
F	145	145A	KIT 145SB	10 1/2	8 1/2	1 1/8	6 1/2	2 3/4	2 1/2	3 3/4	3 7/8	3/8	3	0.119	13/16	5/16x1	3/8x4	6	
F	182	182A	KIT 182SB	12 3/4	9 1/2	1 1/2	6 1/2	3 3/4	2 1/4	4 1/2	4 1/4	1/2	3	0.134	1 1/2	3/8x1 3/4	1/2x6	9	\$100
F	184	184A	KIT 184SB	12 3/4	10 1/2	1 1/2	7 1/2	3 3/4	2 3/4	4 1/2	4 3/4	1/2	3	0.134	1 1/2	3/8s 1 3/4	1/2x6	9	
F	213	213A	KIT 213SB	15	11	1 3/4	7 1/2	4 1/4	2 3/4	5 1/4	4 3/4	1/2	3 1/2	0.164	1 1/2	3/8x1 3/4	1/2x6	13	\$120
F	215	215A	KIT 215SB	15	12 1/2	1 3/4	9	4 1/4	3 1/2	5 1/4	5 1/2	1/2	3 1/2	0.164	1 1/2	3/8x1 3/4	1/2x6	15	
G	254	254B2	KIT 254SB	17 3/4	15 1/8	2	10 3/4	5	4 1/8	6 1/4	6 5/8	5/8	4	3/16	1 7/16	1 1/2x1 3/4	5/8x6	17	\$193
G	256	256B2	KIT 256SB	17 3/4	16 7/8	2	12 1/2	5	5	6 1/4	7 1/2	5/8	4	3/16	1 7/16	1 1/2x1 3/4	5/8x6	18	
G	284	284B2	KIT 284SB	19 3/4	16 7/8	2	12 1/2	5 1/2	4 3/4	7	7 1/2	5/8	4 1/2	3/16	2 1/2	1 1/2x2	5/8x6	21	\$228
G	286	286B2	KIT 286SB	19 3/4	18 3/8	2	14	5 1/2	5 1/2	7	8 1/4	5/8	4 1/2	3/16	2 1/2	1 1/2x2	5/8x6	22	
G	324	324B2	KIT 324SB	22 3/4	19 1/4	2 1/2	14	6 1/4	5 1/4	8	8 1/2	3/4	5 1/4	3/16	2 3/16	5/8x2 1/2	3/4x9	31	\$377
G	326	326B2	KIT 326SB	22 3/4	20 3/4	2 1/2	15 1/2	6 1/4	6	8	9 1/4	3/4	5 1/4	3/16	2 3/16	5/8x2 1/2	3/4x9	32	
G	364	364B2	KIT 364SB	25 1/2	20 1/2	2 1/2	15 1/2	7	5 5/8	9	9 1/8	3/4	6	1/4	2 1/16	5/8x2 1/2	3/4x9	44	\$493
G	365	365B2	KIT 365SB	25 1/2	21 1/2	2 1/2	16 1/2	7	6 1/8	9	9 5/8	3/4	6	1/4	2 1/16	5/8x2 1/2	3/4x9	45	
H	404	404B2	KIT 404SB	28 3/4	22 3/8	3	16 1/2	8	6 1/8	10	9 7/8	7/8	7	1/4	2 1/2	3/4x3	3/4x11	60	\$720
H	405	405B2	KIT 405SB	28 3/4	23 7/8	3	18	8	6 7/8	10	10 5/8	7/8	7	1/4	2 1/2	3/4x3	3/4x11	61	
H	444	444B2	KIT 444SB	31 1/4	24 5/8	3	19 1/4	9	7 1/4	11	11	7/8	7 1/2	1/4	2 1/2	3/4x3	3/4x11	67	\$996
H	445	445B2	KIT 445SB	31 1/4	26 5/8	3	21 1/4	9	8 1/4	11	12	7/8	7 1/2	1/4	2 1/2	3/4x3	3/4x11	69	
H	447	447B2	KIT 447SB	31 1/4	30 1/8	3	24 3/4	9	10	11	13 3/4	7/8	7 1/2	5/16	3	3/4x3 1/2	3/4x11	92	\$1,192
H	449	449B2	KIT 449SB	31 1/4	35 1/8	3	29 3/4	9	12 1/2	11	16 1/4	7/8	7 1/2	5/16	3	3/4x3 1/2	3/4x11	95	

All Kits Listed on This Page are Stock

New & Improved - www.marathonelectric.com

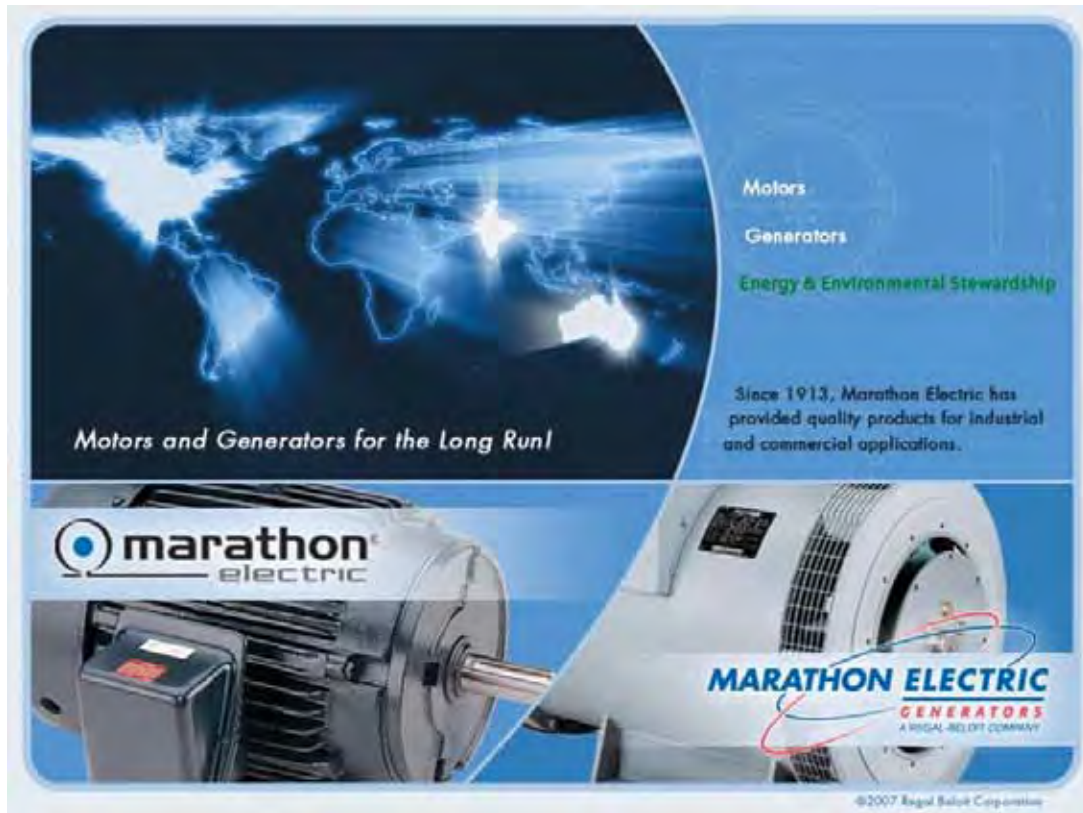

As previously announced the new and improved Marathon Electric website is "live." The new website is a great resource for selecting products, providing technical data, catalogs, brochures, outline drawings, ME-Business eCommerce site and much, much more.

Not only has the look changed, the features have as well. A few of these include: competitive cross-reference, distributor search, motor date code chart and instructions on how to read a model number. A competitive cross reference allows you to find the equivalent Marathon motor to a number of other brands.

The new website is very user-friendly. Simply log onto www.marathonelectric.com. Click on the 'motors' link. If you know the model or catalog number, simply enter it in the search tool at the top of the page. Other functions are listed below.

Products

- AC Motors Search
- DC Motors Search
- Competitive Cross Reference

ME Business

- Log-In Screen

Contact Us

- Home Office Information

Service & Support

- Service Locations
- Distributor Search
- Service Parts
- Standard Warranty Policy
- Frequently Asked Questions
- Motor Date Codes
- How to Read a Model Number
- Warranty Forms

Literature

- Catalogs & Brochures
- Installation, Operation, & Maintenance Manuals
- Terms & Conditions

Log on to the new www.marathonelectric.com today!



SyMAX® Permanent Magnet AC Motors

The most sustainable motor available today



SyMAX® Industrial – Cast Iron Severe Duty
NEMA 182-286T – IEC 132-180



SyMAX-i® with Intellidrive™



Looking for the next level of efficiency?

SyMAX® PMAC motors deliver impressive energy savings by the elimination of rotor conductor losses, optimized fan design, precision-wound stator and variable speed operation. These Ultra Efficient™ motors surpass European IE4 efficiency levels...5 years ahead of scheduled implementation, achieving efficiencies 25-35% over NEMA Premium™! The energy savings alone often pays for the motor in as little as two years. Additionally, the SyMAX® efficiency profile remains flatter than an equivalent induction motor as the speed and load declines, allowing the user to capture even greater energy savings when operated at the application's ideal speed.

Electric motors consume an estimated 25% of all electricity and up to 65% of all electrical energy consumed by industrials. Energy costs are projected to continue to increase in the future. A "mere" 1% gain in energy efficiency would reduce carbon emissions by an estimated 80 million tons per year. SyMAX® motors provide a very cost-effective way to reduce our "carbon footprint" and assure a cleaner environment.

SyMAX® motors provide the highest level of reliability and longevity, coupled with low maintenance costs, due to their low operating temperature, high ingress protection levels and ultra-precision balancing techniques.

SyMAX® Permanent Magnet AC Motors

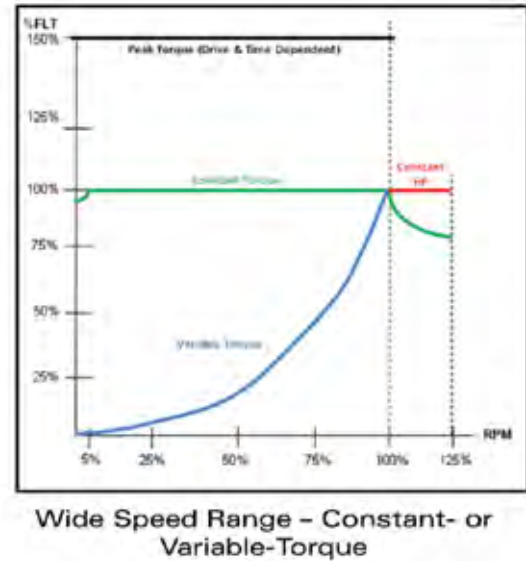
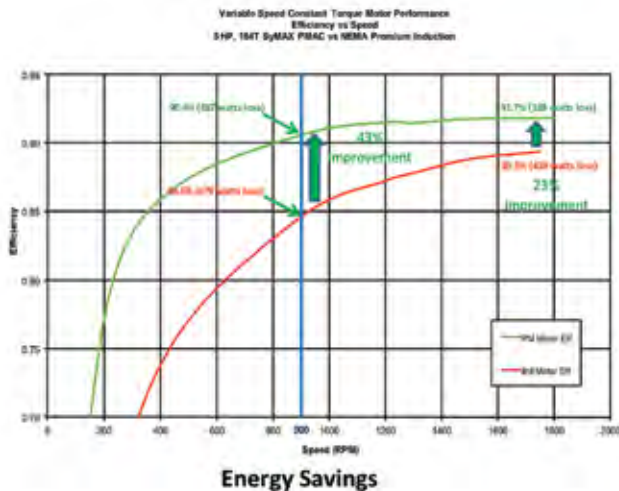

Marathon Electric’s legacy of leadership in AC Variable Speed motors, utilizing the patented MAX GUARD® insulation system and optional shaft grounding devices assures you of a high quality, well-recognized name in the industry.

Let Marathon’s PERFORMANCE-MATCHED SyMAX® motors maximize performance and energy savings in your next variable speed application.

For retrofit applications, SyMAX® motors are a Direct Drop-In replacement for Induction motors, utilizing the same footprint, shaft height and other critical NEMA or IEC prescribed dimensions. New or redesigned machinery installations can exploit the higher power density of Permanent Magnet AC, resulting in a 2-3

frame size reduction, while providing the same output torque...or if you prefer, MORE TORQUE in the same frame size.

Permanent Magnet AC Synchronous motors offer improved speed and torque regulation, dynamic performance, and higher torque/amp, for those applications requiring the ultimate in system performance and throughput.

-Energy Savings
-High Reliability
-Long Life
-Size Reduction
-Performance-Matched
-Reduced Maintenance
-High Performance
-That’s Sustainability...that’s SyMAX®

SyMAX® Permanent Magnet AC Motors

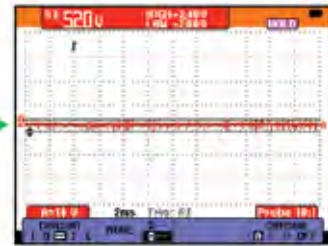
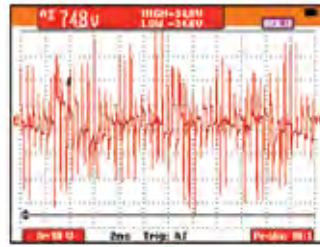

Bearing Current Reduction

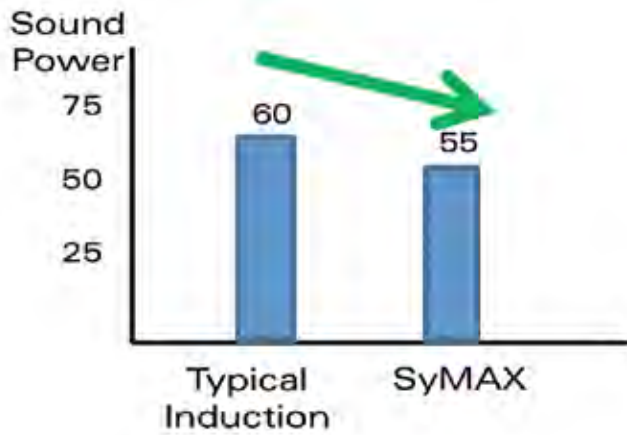

Reduced Sound Levels
(180 frame illustrated)

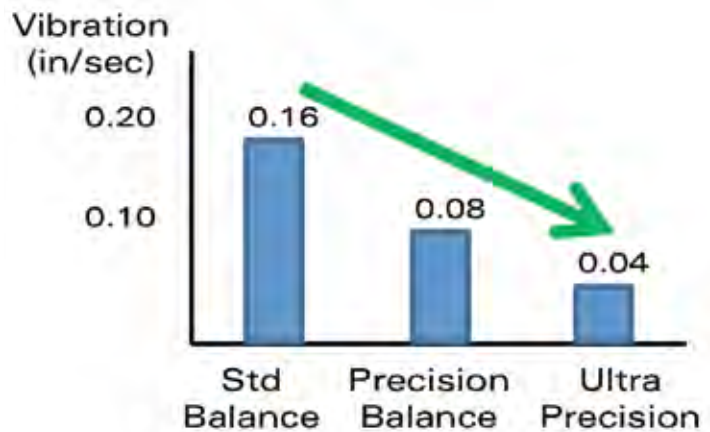

SyMAX® Permanent Magnet AC Motors

Electrical and Mechanical Features

CHARACTERISTIC	COMMERCIAL SyMAX	INDUSTRIAL SyMAX	SyMAX-I
Frame Construction	Steel	Cast Iron	Steel
Enclosure	TENV	TEFC	TENV
Severe Duty	None	Premium	None
Ingress Protection (IP Code)	IP54	IP55	IP54
Bearing System, C3 Clearance	Sealed	Shielded	Sealed
Shaft Seals	None	V-Ring	None
Regreasing Provisions	None	Zerk	None
Fan Guard Material (TEFC)	Poly	Cast Iron	N/A
Endshield Material	Alum	Cast Iron	Alum
Terminal Box Material	Steel	Cast Iron	N/A
Standard Terminal Box Position	F1	F1	N/A
Terminal Block (Single Voltage Only)	Opt	Std	N/A
Auxiliary Grounding Provision (On Frame Foot)	Opt	Std	Opt
Exterior Paint (Black)	Powder Coat	Epoxy	Powder Coat
Overheat Protection	Opt	N/C T' Stat	Opt
Insulation Class	F	H	F
Insulation System	MaxGuard	MaxGuard	MaxGuard
Agency Recognition	UL, CSA, CE	UL, CSA, CE	UL, CSA, CE
CSA Division 2 Certification	N/A	Std	N/A
End-Of-The-Line Production Test Report	Std	Std	Std
Warranty Term	3 Years	3 Years	3 Years

Performance Features

CHARACTERISTIC	COMMERCIAL SyMAX	INDUSTRIAL SyMAX	SyMAX-I
Ultra Efficient™	Std	Std	Std
Low Cogging Torque	Std	Std	Std
Operating Temperature Rise (Maximum)	80°C	80°C	80°C
Variable Torque Speed Range	10 : 1	10 : 1	10 : 1
Constant Torque Speed Range - open loop	20 : 1	20 : 1	20 : 1
Constant Torque Speed Range - closed loop	0 - Base	0 - Base	0 - Base
Full Load Torque - Maximum	72 in-lb	135 in-lb	52.5 in-lb
Constant Power (Beyond Base RPM)	1.25 : 1	1.25 : 1	1.25 : 1
Reserve Torque Capability (up to 1 minute)	150%	150%	150%
Duty Cycle	Continuous	Continuous	Continuous
Ambient Temperature Range	-20 to +40°C	-20 to +40°C	-20 to +40°C
Altitude - Maximum	3000 ft	3000 ft	3000 ft
Balance Specification	Precision	Ultra Precision	Precision

Specials Are Our Specialty

143-449T, IP56,
Hazardous Duty™
Class I and II, Groups
C, D, F & G



6805 DPFV
Cast Iron, Force Ventilated, F2



Roller Table Motor -
Round
Annular fin design, Cast
Iron, FF Flange, F4



Roller Table Motor
- Footed
Annular fin design, Cast
Iron, F4



5007 - 5010 Frame
All New designs



TEFC FIRE PUMP
3Hp to 450Hp,
Red Paint



Shaker Duty,
Hazardous Duty™
210-360 Frame, Round,
Dual Flange



280 IEC TEBC
Blower Cooled,
Ground Brush, F3



440TCZ TEFC
Cast Iron,
Tapered ODE Shaft, F2



Specials Are Our Specialty

320TCZ TEFC
Special Shaft, C-Face



Ground Brush
Opposite Drive End



AEGIS® Shaft
Grounding Ring
Drive End



320 TCZ TEBC
Blower Cooled, Special
ODE shaft, C-Face



320 TZ TENV
Non Ventilated, Special
ODE Shaft, Encoder



5007-5013 Vertical
Frames
TENV and TEFC



400TC TEBC
Blower Cooled, C-Face, F3



Marathon's "IntelliBrake"
Stearns & Dings Brakes
with Imbedded Encoder



440TD TEFC Round
Cast Iron, Round, D-Flange



Index

Catalog Number/Model Number

CAT. NO.	MODEL NO.	STOCK	PAGE NO.	CAT. NO.	MODEL NO.	STOCK	PAGE NO.	CAT. NO.	MODEL NO.	STOCK	PAGE NO.	MODEL NO.	CAT. NO.	STOCK	PAGE NO.
25U21T	KIT 250U	✓	204	3596	SEE X023		147	4701	5KH39QN5512T	✓	150	A128-(GE)	SEE AG128		195
28U25T	KIT 280U	✓	204	3727	SEE X411		165	4702	5KH33HN5725X	✓	150	A129-(GE)	SEE AG129		195
32U28T	KIT 320U	✓	204	3728	SEE X412		143	4706	5KH39QN5514T	✓	151	A130-(GE)	SEE AG130		195
36U32T	KIT 360U	✓	204	3729	SEE X413		143	4707	5KH33HN5722X	✓	151	A157	KIT VRT87BRK	✓	194
40U36T	KIT 400U	✓	204	3730	SEE X414		143	4708	5KH39QN9401T	✓	151	A160	KIT 180TCD-WD	✓	190
44U40T	KIT 440U	✓	204	3732	SEE X412		143	4709	5KH36MN5729X	✓	151	A161	KIT 210TCD-WD	✓	190
143A	KIT 143SB	✓	204	3733	SEE X415		143	4722	5KH39QN5558T	✓	159,166	A162	KIT 250TCD2-WD	✓	190
145A	KIT 145SB	✓	204	3736	SEE X456		143	4725	5KH32DN5587X	✓	113	A163	KIT 250TCD-WD	✓	190
182A	KIT 182SB	✓	204	3737	SEE X457		143	4730	5KH39QN9725T	✓	155	A164	KIT 280TCD2-WD	✓	190
184A	KIT 184SB	✓	204	3738	SEE X458		143	4731	5KH39QN9696X	✓	155	A165	KIT 280TCD-WD	✓	190
213A	KIT 213SB	✓	204	3739	SEE X459		143	4732	5KH39QN9702T	✓	155	A166	KIT 320TCD2-WD	✓	190
215A	KIT 215SB	✓	204	3746	SEE X452		143	4733	5KH39DNA533T	✓	155	A167	KIT 320TCD-WD	✓	190
254B2	KIT 254SB	✓	204	3783	SEE X034		148	4734	5KH32HNA532T	✓	155	A168	KIT 360TCD2-WD	✓	190
256B2	KIT 256SB	✓	204	3785	SEE X035		148	4735	5KH33JNA534T	✓	155	A169	KIT 360TCD-WD	✓	190
284B2	KIT 284SB	✓	204	3787	SEE X036		148	4738	5KH39QN9703T	✓	155	A170	KIT 180TCF-WD	✓	191
286B2	KIT 286SB	✓	204	3945	SEE X445		144	4739	5KH39QN9704T	✓	155	A171	KIT 210TCF-WD	✓	191
324B2	KIT 324SB	✓	204	3946	SEE X446		144	4757	5KH39QN9636T	✓	151	A172	KIT 250TCF2-WD	✓	191
326B2	KIT 326SB	✓	204	4050	SEE 4370		151	4758	5KH39QN9698T	✓	151	A173	KIT 250TCF-WD	✓	191
364B2	KIT 364SB	✓	204	4304	5KH39QN5543	✓	150	4759	5KH39QN9697T		151	A174	KIT 280TCF2-WD	✓	191
365B2	KIT 365SB	✓	204	4305	5KH39QN5511X	✓	150	4773	SEE O005		156	A175	KIT 280TCF-WD	✓	191
404B2	KIT 404SB	✓	204	4306	5KH39QN5537X	✓	150	4774	5KH33GN5014U	✓	156	A176	KIT 320TCF2-WD	✓	191
405B2	KIT 405SB	✓	204	4308	SEE 4706		151	4776	5KH39QN5539T	✓	26	A177	KIT 320TCF-WD	✓	191
444B2	KIT 444SB	✓	204	4309	5KH39QN9514X	✓	151	4777	5KCP100EZA001X	✓	156	A178	KIT 360TCF2-WD	✓	191
445B2	KIT 445SB	✓	204	4310	5KH39QN5508X		26	4778	5KH39QN9639T	✓	26	A179	KIT 360TCF-WD	✓	191
447B2	KIT 447SB	✓	204	4311	5KH39QN5529X	✓	26	4779	SEE O100		156	A181	KIT 143TCTN-841	✓	192
449B2	KIT 449SB	✓	204	4314	5KH39QN5520X	✓	150	4781	5KC37HN3898U		156	A182	KIT 180TCFS-841	✓	192
1814T	KIT 180U	✓	204	4319	5KH39QN9429T	✓	150	4782	SEE O600		156	A183	KIT 210TCFS-841	✓	192
2118T	KIT 210U	✓	204	4322	5KH39QN9548	✓	150	4784	SEE O601		156	A184	KIT 250TCFNA-841	✓	192
3001	SEE X230		158,163	4338	5KH39QN9541T	✓	151	4785	5KH32EN5015U	✓	156	A185	KIT 280TCFNA-841	✓	192
3028	SEE X080		141	4349	5KH39QN9537X	✓	21	4786	SEE O002		156	A186	KIT 280TCFNA-841	✓	192
3037	SEE X090		142	4350	5KH39QN5538X	✓	150	4787	SEE O003		156	A187	KIT 320TCFS-841	✓	192
3048	SEE X085		142	4351	5KH39QN9542	✓	23	4788	5KC37EN3900U	✓	156	A188	KIT 360TCFSR-841	✓	192
3050	SEE X209		147,165	4352	SEE S102		25	4798	5KH35FN153T	✓	150	A189	KIT 360TSCFSR-841	✓	192
3070	SEE X200		166	4354	5KH39QN9538	✓	21	4805	5KH32GNB811X	✓	113	A190	KIT 400TCFS-841	✓	192
3082	SEE X236		147,162,165	4355	5KH39QN5525	✓	150	9029	5KC49NN0221X	✓	23	A191	KIT 400TSCFS-841	✓	192
3084	SEE X441		142	4359	5KH39QN5523	✓	25	9030	5KC49NN0222X		174	A192	KIT 440TCFS-841	✓	192
3085	SEE X442		142	4360	5KH39QN5548	✓	150	9031	5KC49MN2043Y	✓	21,168	A193	KIT 440TSCFS-841	✓	192
3086	SEE X443		142	4362	5KH39QN9686X	✓	21	9032	5KC49MN2049Y	✓	21,168,174	A194	KIT 440TCFNA-841	✓	192
3132	SEE X203		162	4363	5KH39QN5526X	✓	150	9033	5KC49NN2050Y	✓	21,168	A195	KIT 440TSCFNA-841	✓	192
3155	SEE X278		142,165	4364	5KH39QN5541X	✓	25	9034	5KC49NN2044Y	✓	23	A195-(GE)	SEE AG195		196
3204	SEE X450		143	4368	5KH39QN9397		23	9035	5KCF48TN2650Y	✓	22,23,168	A197	KIT 197	✓	199
3205	SEE X451		143	4369	5KH39QN5508	✓	26	9036	5KCF48UN2653Y	✓	22,168	A198	KIT 198	✓	199
3206	SEE X302		159	4370	5KH39QN9682	✓	151	9038	5KCF48ZN2151U	✓	23,168	A199	KIT 199	✓	199
3208	SEE X303		159	4371	5KH39QN5529	✓	26	9040	5KCF48UN2654Y	✓	168	A201	KIT 201	✓	199
3212	SEE X304		159	4372	5KH39QN9546	✓	23	A000	KIT 391-200-01	✓	200	A202	KIT 202	✓	199
3220	SEE X216		142,165	4373	5KH39QN9543	✓	23	A001	KIT 391-200-02	✓	200	A204	KIT 210TCFL	✓	191
3221	SEE X297		142,165	4376	5KH39QN9547		23	A100	KIT 100	✓	197	A206	KIT 210TCFS	✓	191
3230	SEE X416		143	4377	5KH39QN5524	✓	26	A103	KIT 103	✓	203	A209	KIT 250TCFL	✓	191
3280	SEE X037		148	4380	5KH39QN9681X	✓	23	A104	KIT 104	✓	196	A212-(GE)	SEE AG212		190
3288	SEE X405		162	4381	5KH39QN5528X	✓	26	A105	KIT 105	✓	198	A214	KIT 320TCFS	✓	191
3290	SEE X039		148	4383	5KH39QN9513X	✓	151	A106	KIT 106	✓	198	A215-(GE)	SEE AG215		191
3328	SEE X213		141	4386	SEE S120		26	A107	KIT 107-637	✓	195	A216	KIT 360TCDS	✓	190
3329	SEE X214		142	4387	5KH39QN9684	✓	26	A109	KIT 109	✓	203	A217	KIT 360TCFS	✓	191
3330	SEE X221		142	4389	5KH39QN9548X	✓	150	A109-(GE)	SEE AG109		195	A219	KIT 360TSCDS	✓	190
3331	SEE X298		142	4390	5KH39QNA039	✓	151	A110	KIT 110	✓	196	A222	KIT 400TCDS	✓	190
3463	SEE X077		161	4392	5KH39QN9405X	✓	151	A110-(GE)	SEE AG110		195	A223	KIT 400TCFS	✓	191
3464	SEE X073		161	4393	5KH39QN9544X	✓	151	A111	KIT 111	✓	197	A224-(GE)	SEE AG105		198
3465	SEE X072		160	4396	5KH39QN9683	✓	150	A111-(GE)	SEE AG111		195	A225	KIT 400TSCDS	✓	190
3466	SEE X074		161	4399	5KH39QN9551X	✓	150	A112	KIT 112	✓	196	A225-(GE)	SEE AG106		198
3467	SEE X075		161	4404	5KH39QN5550X	✓	159,166	A112-(GE)	SEE AG112		195	A226	KIT 400TSCFS	✓	191
3468	SEE X076		160	4406	5KH32FN5586X	✓	113	A113	KIT 113	✓	196	A228	KIT 440TCDS	✓	190
3583	SEE X000		147	4412	5KH39QN9550X	✓	150	A113-(GE)	SEE AG113		195	A228-(GE)	SEE AG228		198
3584	SEE X001		147	4422	5KH39QN9687	✓	26	A114	KIT 114	✓	196	A229	KIT 440TCFS	✓	191
3585	SEE X002		147	4602	5KH39QN9518X	✓	26	A114-(GE)	SEE AG114		195	A229-(GE)	SEE AG229		198
3586	SEE X003		147	4680	5KH32FN3120T	✓	150	A115-(GE)	SEE AG115		195	A231	KIT 440TSCDS	✓	190
3587	SEE X004		147	4682	5KH35JN3132T	✓	151	A116	KIT 116	✓	203	A232	KIT 440TSCFS	✓	191
3588	SEE X005		147	4684	5KH36MN3127T	✓	151	A119	KIT 364-445CB	✓	199	A234	KIT 234	✓	199
3589	SEE X009		147	4686	5KC46LN0269X	✓	152	A125-(GE)	SEE AG125		195	A239	KIT 250TCFPA	✓	191
3590	SEE X010		147	4688	5KC49NN0061T	✓	152	A127-(GE)	SEE AG127		195	A240	KIT 240	✓	195

Catalog Number/Model Number

CAT. NO.	MODEL NO.	STOCK	PAGE NO.	CAT. NO.	MODEL NO.	STOCK	PAGE NO.	CAT. NO.	MODEL NO.	STOCK	PAGE NO.	CAT. NO.	MODEL NO.	STOCK	PAGE NO.
A241	KIT 241	✓	195	A436	KIT 140TCDR-1	✓	190	A580	KIT 175995	✓	193	A668	KIT A02H1024-BC LED	✓	202
A242	KIT 242	✓	195	A437	KIT 56CFR-1	✓	191	A581	KIT 175985	✓	193	A669	KIT A02H2048-BC LED	✓	202
A243	KIT 243	✓	197	A438	KIT 140TCFR-1	✓	191	A581A	KIT 175817	✓	193	A686	KIT EPC260 2048	✓	202
A244	KIT 244	✓	197	A445	KIT 440-7.5	✓	197	A582	KIT 175987	✓	193	A687	KIT HS201024-NV	✓	202
A245	KIT 245	✓	197	A446	KIT 440-10	✓	197	A582A	KIT 175818	✓	193	A688-10	KIT A688-10	✓	202
A247	KIT 247	✓	199	A459-(GE)	SEE A104		196	A582B	KIT 175832	✓	193	A688-20	KIT A688-20	✓	202
A248	KIT 248	✓	199	A478-(GE)	SEE A111		197	A583	KIT 175989	✓	193	A688-25	KIT A688-25	✓	202
A249	KIT 249	✓	196	A487-(GE)	SEE A243		197	A583A	KIT 175819	✓	193	A688-30	KIT A688-30	✓	202
A250	KIT 250	✓	196	A488-(GE)	SEE A244		197	A584	KIT 175991	✓	193	A688-50	KIT A688-50	✓	202
A251	KIT 251	✓	196	A489-(GE)	SEE A245		197	A585	KIT 175900	✓	193	A688-60	KIT A688-60	✓	202
A252	KIT 252	✓	196	A493-(GE)	SEE A114		196	A586	KIT 175901	✓	193	A688-100	KIT A688-100	✓	202
A253	KIT 253	✓	196	A494-(GE)	SEE A110		196	A587	KIT 175902	✓	193	A690-15	KIT A690-15	✓	202
A254	KIT 254	✓	196	A496	KIT EP2400	✓	203	A588	KIT 175903	✓	193	A691	KIT 25TEBCNA	✓	201
A256	KIT 256	✓	198	A499-1	KIT SGR-0.625-UK	✓	203	A594	KIT 175835	✓	193	A692	KIT 21TEBC	✓	201
A257	KIT 257	✓	198	A499-2	KIT SGR-0.875-UK	✓	203	A596	KIT 175836	✓	193	A695	KIT 32TEBC	✓	201
A258	KIT 258	✓	198	A499-3	KIT SGR-1.125-UK	✓	203	A598	KIT 175837	✓	193	A696	KIT 36TEBC	✓	201
A259	KIT 259	✓	197	A499-4	KIT SGR-1.375-UK	✓	203	A600	KIT 175181	✓	190	A697	KIT 40TEBC	✓	201
A261	KIT 261	✓	199	A499-5	KIT SGR-1.625-UK	✓	203	A601	KIT 250TCFP	✓	191	A698	KIT 44TEBC-313	✓	201
A262	KIT 145TCTN-841	✓	192	A499-6	KIT SGR-1.875-UK	✓	203	A602	KIT 175066	✓	190	A699	KIT 44TEBC-316	✓	201
A277	KIT 277	✓	197	A499-7	KIT SGR-2.125-UK	✓	203	A603	KIT 143TCFN	✓	191	A700	KIT 44TEBC-318	✓	201
A278	KIT 278	✓	197	A499-8	KIT SGR-2.375-UK	✓	203	A606	KIT 210TCDW	✓	190	A701	KIT 28TEBCNA	✓	201
A279	KIT 279	✓	195	A499-9	KIT SGR-2.875-UK	✓	203	A609	KIT 210TCFW	✓	191	A711	KIT HSD351024-NV	✓	202
A280	KIT 280	✓	195	A499-10	KIT SGR-3.375-UK	✓	203	A610	KIT 280TCDP	✓	190	A712	KIT HSD351024-FC	✓	202
A281	KIT 281	✓	195	A500-5	KIT SGR-11.2	✓	203	A611	KIT 280TCFP	✓	191	A715	KIT 140CB	✓	201
A282	KIT 282	✓	195	A500-8	KIT SGR-14.4	✓	203	A612	KIT 250TCDX	✓	190	A718	KIT 180R	✓	201
A283	KIT 283	✓	195	A500-14	KIT SGR-20.7	✓	203	A613	KIT 320TCDP	✓	190	A720	KIT 180/210CB	✓	199
A284	KIT 250TCFNA	✓	191	A500-20	KIT SGR-27.1	✓	203	A614	KIT 320TCFP	✓	191	A721	KIT 210R	✓	201
A287	KIT 280TCD	✓	190	A500-26	KIT SGR-33.4	✓	203	A615	KIT 280TCFN	✓	191	A722	KIT 250CB	✓	199
A293	KIT 440TSCDN	✓	190	A500-32	KIT SGR-39.8	✓	203	A617	KIT 280TCFPA	✓	191	A723	KIT 250RFFPA	✓	201
A297	KIT 3BRK3A	✓	194	A500-38	KIT SGR-46.1	✓	203	A618	KIT 280TCFNA	✓	191	A724	KIT 250RFFNA	✓	201
A298	KIT 6BRK3A	✓	194	A500-44	KIT SGR-52.5	✓	203	A619	KIT 320TCFPA	✓	191	A725	KIT 250R	✓	201
A299	KIT 10BRKA	✓	194	A500-50	KIT SGR-58.8	✓	203	A620	KIT 440TCFN	✓	191	A726	KIT 280RFFPA	✓	201
A301	KIT 3BRK3	✓	194	A500-62	KIT SGR-71.5	✓	203	A621	KIT 440TSCFN	✓	191	A727	KIT 280RFFN	✓	201
A302	KIT 6BRK3	✓	194	A500-74	KIT SGR-84.2	✓	203	A622	KIT 175067	✓	190	A728	KIT 280R	✓	201
A303	KIT 10BRK	✓	194	A518	161L110AAG4	✓	196	A623	KIT 449TCFS	✓	191	A729	KIT 280CB	✓	199
A306	KIT 3BRK1	✓	194	A534	161L187BAG1	✓	190	A624	KIT 449TSCFS-1	✓	191	A730	KIT 320CB	✓	199
A307	KIT 6BRK1	✓	194	A535	161L187BCG1	✓	190	A625	KIT 449TSCFS-2	✓	191	A731	KIT 280RFFNA	✓	201
A308	KIT 308	✓	195	A536	161L188BAG1	✓	191	A626	KIT 175058	✓	190	A733	KIT 320RFFPA	✓	201
A311	KIT 311	✓	199	A537	161L188BCG1	✓	191	A627	KIT 175059	✓	190	A736	KIT HS35A1024-NV	✓	202
A312	KIT BM6BRK	✓	194	A549	52A101229AAG1	✓	199	A628	KIT 175060	✓	190	A737	KIT HS35A1024-FC	✓	202
A313	KIT BM10BRK	✓	194	A554	KIT 175984	✓	193	A629	KIT 175601	✓	190	A738	KIT HS35A1024-BC	✓	202
A315	KIT BM6BRK575	✓	194	A554A	KIT 175810	✓	193	A630	KIT 180TDFR	✓	192	A739	KIT HS35A2048-NV	✓	202
A316	KIT BM10BRK575	✓	194	A555	KIT 175986	✓	193	A631	KIT 280TDFP	✓	192	A740	KIT HS35A2048-FC	✓	202
A317	KIT BM6BRK115	✓	194	A555A	KIT 175811	✓	193	A632	KIT 320TDFP	✓	192	A742	KIT HS35M1024	✓	202
A318	KIT BM10BRK115	✓	194	A555B	KIT 175827	✓	193	A634	KIT 400TDFS	✓	192	A746	KIT HS25A1024-NV	✓	202
A371	KIT 370-3	✓	197	A556	KIT 175988	✓	193	A637	KIT 360TDFC	✓	192	A747	KIT HS25A2048-NV	✓	202
A372	KIT 370-4	✓	197	A556A	KIT 175812	✓	193	A640	KIT 180TCN4.5	✓	191	A748	KIT M561024BRK-140	✓	202
A373	KIT 370-5	✓	197	A557	KIT 175990	✓	193	A641	KIT 180TCN8.5	✓	191	A749	KIT M561024BRK-182	✓	202
A375	KIT 370-7.5	✓	197	A558	KIT 175890	✓	193	A642	KIT 175077	✓	191	A750	KIT M851024BRK-184	✓	202
A376	KIT 370-10	✓	197	A559	KIT 175994	✓	193	A643	KIT 175296	✓	191	A751	KIT M851024BRK-210	✓	202
A378	KIT 370-15	✓	197	A561	KIT 631475	✓	193	A644	KIT 180CF8.5-1	✓	191	A752	KIT M851024BRK-250	✓	202
A379	KIT 370-17.5	✓	197	A562	KIT 711485	✓	193	A645	KIT 180CF4.5-1	✓	191	A753	KIT M31024-NV	✓	202
A380	KIT 370-20	✓	197	A563	KIT 8014100	✓	193	A646	KIT 210TCN	✓	191	A754	KIT M31024-FC	✓	202
A381	KIT 370-25	✓	197	A564	KIT 9014115	✓	193	A647	KIT 250TDFPA	✓	192	A755	KIT 360BRFSR-314	✓	201
A382	KIT 370-30	✓	197	A565	KIT 10014130	✓	193	A648	KIT 250TDFNA	✓	192	A756	KIT 400BRFS-316	✓	201
A395	KIT 360TCFSR	✓	191	A566	KIT 11214130	✓	193	A649	KIT 649R	✓	192	A757	KIT 440BRFS-318	✓	201
A396	KIT 360TCFSR	✓	191	A567	KIT 13214165	✓	193	A650	KIT 650R	✓	192	A758	KIT 449BRFS	✓	201
A414	KIT 400TCD2-WD	✓	190	A568	KIT 16014215	✓	193	A651	KIT 651R	✓	192	A759	KIT 440BRFN	✓	201
A415	KIT 400TCD-WD	✓	190	A569	KIT 635115	✓	193	A652	KIT 175068	✓	191	A760	KIT 440BBFN	✓	201
A416	KIT 444/5TCD2-WD	✓	190	A570	KIT 715130	✓	193	A653	KIT 175191	✓	191	A761	KIT 449BBFS	✓	201
A417	KIT 444/5TCD-WD	✓	190	A571	KIT 805165	✓	193	A654	KIT 175061	✓	191	A763	KIT LKSR02	✓	202
A419	KIT 447/9TCD-WD	✓	190	A572	KIT 905165	✓	193	A655	KIT 145TCFN	✓	191	A764	KIT LKSR03	✓	202
A424	KIT 400TCF2-WD	✓	191	A573	KIT 1005215	✓	193	A656	KIT 280TDFNA	✓	192	A772	KIT HS351024-NV	✓	202
A425	KIT 400TCF-WD	✓	191	A574	KIT 1125215	✓	193	A657	KIT 320TDFPA	✓	192	A774	KIT HS351024-FC	✓	202
A426	KIT 444/5TCF2-WD	✓	191	A575	KIT 1325265	✓	193	A658	KIT 320TDFS	✓	192	A775	KIT HS351024-BC	✓	202
A427	KIT 444/5TCF-WD	✓	191	A576	KIT 1605300	✓	193	A662	KIT 175614	✓	199	A776	KIT HS352048-NV	✓	202
A428	KIT 447/9TCF2-WD	✓	191	A577	KIT 1805300	✓	193	A665	KIT 175076	✓	191	A777	KIT HS352048-FC	✓	202
A429	KIT 447/9TCF-WD	✓	191	A578	KIT 2005350	✓	193	A666	KIT 175691	✓	191	A778	KIT HS352048-BC	✓	202
A435	KIT 56CDR-1	✓	190	A579	KIT 2255400	✓	193	A667	KIT 175844	✓	191	A779	KIT HS35B1024-NV	✓	202
												A779A	KIT HS35A/B1024-NV	✓	202



Index

Catalog Number/Model Number

CAT. NO.	MODEL NO.	STOCK	PAGE NO.	CAT. NO.	MODEL NO.	STOCK	PAGE NO.	CAT. NO.	MODEL NO.	STOCK	PAGE NO.	MODEL NO.	CAT. NO.	STOCK	PAGE NO.
A780	KIT HS35B2048-NV	✓	202	A1303	KIT BRK-10 208-230/460	✓	194	B387	SEE H173		151	C163	SEE C123B		40
A780A	KIT HS35AB2048-NV	✓	202	A1306	KIT BRK-3 115/230	✓	194	B388	SEE H174		151	C164	5KC37NN15	✓	21
A781	KIT HS35B1024-BC	✓	202	A1307	KIT BRK-6 115/230	✓	194	B389	SEE H175		151	C167	5KC49GN0010	✓	21
A782	KIT HS35B2048-BC	✓	202	AG109	161L113AAG1	✓	195	B400	48S17D997	✓	140	C168	5KC49GN0010X	✓	21
A783	KIT HS35B1024-FC	✓	202	AG110	161L113AAG2	✓	195	B401	56S17D2062	✓	140	C169	5KC49GN0010Y	✓	21,168
A783A	KIT HS35AB1024-FC	✓	202	AG111	161L113AAG3	✓	195	B402	48S17D7209	✓	140	C173	182TCDR8007		27
A784	KIT HS35B2048-FC	✓	202	AG112	161L113AAG4	✓	195	B500	SEE H236		153	C174	184TCDR7627		27
A784A	KIT HS35AB2048-FC	✓	202	AG113	161L113AAG5	✓	195	B501	SEE H234		153	C175	5KC46LN0153	✓	21
A785	KIT LKRSR512	✓	202	AG114	161L113AAG6	✓	195	B502	SEE B1502		153	C176	5KC46LN0153X	✓	21
A786	KIT LKSR-CFACE	✓	202	AG115	161L113AAG9	✓	195	B504	SEE B1504		153	C177	5KC46LN0153U	✓	21
A787	KIT 449BBFS-322	✓	201	AG125	161L113ADG1	✓	195	B506	56S17F5303		153	C178	5KCR49WN6075	✓	21
A788	KIT 449BBFS-319	✓	201	AG127	161L113ADG3	✓	195	B507	SEE B1507		153	C179	5KC38RN60	✓	21
A789	KIT SL561024-182NV	✓	202	AG128	161L113ADG4	✓	195	B600	SEE H176		151	C180	5KC38RN60X	✓	21
A790	KIT SL851024-184NV	✓	202	AG129	161L113ADG5	✓	195	B604	SEE H169		150	C181	5KC49PN0161	✓	21
A791	KIT SL851024-210NV	✓	202	AG130	161L113ADG14	✓	195	B605	SEE H170		150	C182	5KC49PN0161X	✓	21
A792	KIT SL851024-250NV	✓	202	AG195	161L110AA1	✓	196	B606	48S17D2116	✓	150	C183	5KCR49QN6076	✓	21
A793	KIT M561024-NV	✓	202	AG212	161L185AAG1	✓	190	B607	48S17D2117	✓	151	C185	5KCR49SN0068	✓	22
A794	KIT M561024-BC	✓	202	AG215	161L186AAG1	✓	191	B608	56C17D2113	✓	152	C186	5KCR49SN0068X	✓	22
A795	KIT L449BBFS-322	✓	201	AG228	112A515AKG4	✓	198	B609	56B17D2013	✓	152	C187	5KC48TN2169	✓	22
A796	KIT L449TEBC	✓	201	AG229	112A515ASG2	✓	198	B703	48N17D14	✓	151	C188	5KC49PN0162	✓	21
A800	KIT 56 EXPR BOX	✓	199	AG234	161L528AAG1	✓	199	B1316	5KC49GN0001	✓	24,152	C191	5KCR49SN0065	✓	22
A801	KIT ENCBOX	✓	202	AG697	161L210AAP1	✓	200	B1502	5KH39QN9105	✓	153	C193	5KCR49WN0270	✓	22
A803	KIT LDRDCH-M	✓	199	B100	56S17D2064	✓	151	B1504	5KH35MN56	✓	153	C194	5KCR48TN8062	✓	22
A807	KIT STUBSHAFT 1IN	✓	202	B193	56T34D5357	✓	154	B1507	5KH42GN0336	✓	153	C200	5KC35JN12	✓	24
A903	KIT 903	✓	194	B200	56S17D2049	✓	151	C102	SEE C102A		40	C201	143TFR5302	✓	53
A904	KIT 904	✓	194	B201	56S17D2047	✓	150	C102A	145TTDR14007	✓	40	C201A	143TFR4302	✓	53
A905	KIT 905	✓	194	B202	56S17D2048	✓	151	C103	145TTDR5312	✓	40	C201-(GE)	SEE CG201		24
A906	KIT 906	✓	194	B206	48S17D2107	✓	150	C104B	182TTDW14008	✓	40	C202	SEE C202A		53
A907	KIT 907	✓	194	B207	48S17D2108	✓	151	C105	SEE C105B		40	C202A	145TTFR4306	✓	53
A908	KIT 908	✓	194	B208	48S17D2109	✓	151	C105B	184TTDW14017	✓	40	C202-(GE)	SEE G1114		24,152
A909	KIT 909	✓	194	B210	SEE C216		24,152	C105-(GE)	SEE CG105		23	C203	182TTFR7325	✓	54
A910	KIT 910	✓	194	B300	48S17D2052	✓	150	C106	SEE C106A		40	C203B	182TTFW14004	✓	54
A911	KIT 911	✓	194	B302	48S17D2054	✓	150	C106A	213TTDW14014	✓	40	C203-(GE)	SEE G1115		24,152
A940	52D310833AAP001	✓	200	B303	48S17D2055	✓	150	C111	SEE K1301		40	C204	SEE C204B		54
A941	52D311808ARP1	✓	200	B304	48S17D2056	✓	151	C111-(GE)	SEE CG111		23	C204B	184TTFW14004	✓	54
A942	52D310814AAP1	✓	200	B305	48S17D2057	✓	151	C120	SEE K634A		40	C205	SEE C205A		54
A945	115D964P1	✓	200	B306	48S17D2058	✓	151	C121	SEE K622		40	C205A	213TTFW14011	✓	54
A946	115D964P2	✓	200	B307	48S17D2059	✓	151	C122A	145TTDR4341	✓	40	C206	SEE C206A		54
A947	115D963P1	✓	200	B308	SEE H208		155	C123	SEE C123B		40	C206A	215TTFW14024	✓	54
A948	113A617AG001	✓	200	B309	SEE H212		155	C123B	182TTDW4028	✓	40	C207	SEE C207A		54
A949	113A620AYP1	✓	200	B310	SEE C235		24,152	C124	SEE C124B		40	C207A	254TTFL14009		54
A950	976B399AAP9	✓	200	B311	SEE 4688		152	C124A	SEE C124B		40	C208	5KC35FN51X	✓	24
A951	976B399AAP12	✓	200	B312	48C17D2041	✓	152	C124B	184TTDW14027	✓	40	C209	5KC36LN26	✓	24
A952	976B399AAP13	✓	200	B313	48C17D2042	✓	152	C125	SEE C125A		40	C210	5KC36LN26X	✓	24
A953	976B399ABP6	✓	200	B314	48C17D2043	✓	152	C125A	213TTDW14057		40	C215	5KC36LN1	✓	24
A954	976B399ABP9	✓	200	B315	48C17D2044	✓	152	C126	SEE C126A		40	C216	5KC36LN1X	✓	24,152
A955	976B399ABP10	✓	200	B316	SEE B1316		24,152	C126A	215TTDW14071		40	C219	5KC36JN267	✓	21
A956	161L198AAG9	✓	200	B317	56C17D2072	✓	24,152	C129	5KC35JN23X		26	C220	SEE C220A		53
A957	161L198AAG10	✓	200	B318	56C17D2073	✓	24,152	C133	5KC36MN27X	✓	26	C220A	143TFR4329	✓	53
A958	161L197ABG1	✓	200	B319	56C17D2074	✓	24,152	C136	SEE S113		26	C221	SEE C221A		53
A959	161L197ABG11	✓	200	B320	SEE H217		155	C138	5KC46JN0002X	✓	24	C221A	145TTFR4332	✓	53
A960A	003062.09	✓	200	B321	SEE H290		155	C145	5KC35JN8X	✓	21	C221-(GE)	SEE B1316		24,152
A961	111A271P111	✓	200	B322	48S17D2053	✓	150	C147	5KC35JN10	✓	21	C222	SEE K2033		53
A962	52D310822ACP1	✓	200	B330	SEE C1160		25,152	C148	5KC35JN10X	✓	21	C223	SEE C223B		54
A963	52D311819ABP1	✓	200	B331	SEE C420		152	C150	SEE C150		40	C223B	182TTFW4027	✓	54
A964	52A103486G1	✓	200	B332	56B17D5701		152	C150A	145TTDR14088	✓	40	C223-(GE)	SEE CG223		24
A965	111A271P113	✓	197	B334	SEE C475		152	C152	SEE C152A		40	C224	SEE C1224		54
A1000	KIT 180-210 TERM BLK	✓	193	B335	56B17D5703	✓	152	C152A	184TTDW14078		40	C225	SEE C225A		54
A1001	KIT 250-320 TERM BLK	✓	193	B336	56C17D5347	✓	25,152	C153	5KC36LN30	✓	21	C225A	213TTFW14045	✓	54
A1002	KIT 360 TERM BLK	✓	193	B337	56C17D5348	✓	152	C154	5KC36LN30X	✓	21	C226	SEE C226A		54
A1003	KIT 400-445 TERM BLK	✓	193	B338	56C17D5349	✓	152	C155	SEE C155A		40	C226A	215TTFW14041	✓	54
A1004	KIT 447.9 TERM BLK	✓	193	B348	SEE 4392		151	C155A	254TTDX14089		40	C227	SEE C227A		54
A1209	KIT 250TCFL-R	✓	191	B350	SEE C486		152	C156	SEE C156A		40	C227A	254TTFL14037	✓	54
A1287	KIT 280TCDC	✓	190	B352	56B17D5331	✓	25,152	C156A	256TTDX14087		40	C230	143TFR5333		53
A1297	KIT BRK-3 575	✓	194	B353	56B17D67	✓	152	C158	5KC36LN7	✓	21	C230A	143TFR4333		53
A1298	KIT BRK-6 575	✓	194	B380	SEE H209		155	C159	5KC36LN7X	✓	21	C230-(GE)	SEE CG230		24,152
A1299	KIT BRK-10 575	✓	194	B381	SEE H214		155	C162	SEE C162A		40	C231	145TFR5340		53
A1301	KIT BRK-3 208-230/460	✓	194	B383	SEE H171		150	C162A	145TTDR14087		40	C231A	145TFR4340		53
A1302	KIT BRK-6 208-230/460	✓	194	B384	SEE H172		150	C162-(GE)	SEE G1098		21	C231-(GE)	SEE D1113		24,152

Catalog Number/Model Number

CAT. NO.	MODEL NO.	STOCK	PAGE NO.	CAT. NO.	MODEL NO.	STOCK	PAGE NO.	CAT. NO.	MODEL NO.	STOCK	PAGE NO.	CAT. NO.	MODEL NO.	STOCK	PAGE NO.
C232	145TFFR5341		53	C307A	254TTGP14013	✓	80	C370A	213TTGN6536		78	C476	5KCR49SN3010	✓	25,152
C232A	145TFFR14048		53	C308	SEE C308A		80	C370-(GE)	SEE G1519		31	C486	5KCR49PN3012X	✓	25,152
C232-(GE)	SEE CG232		24	C308A	256TTGN14011		80	C371	SEE C371A		78	C548	5KC49PN6051X	✓	24
C235	5KC49PN0155	✓	24,152	C320	SEE C320A		80	C371A	215TTGN16534		78	C552	5KC48UN6052X	✓	24
C236	SEE C236A		54	C320A	143TTGN4062	✓	80	C371-(GE)	SEE G1531		31	C636	SEE S117		26
C236A	145TFFR4307	✓	54	C321	SEE C321A		80	C375	5KC42GN0066	✓	32	C646	5KC36PNB169X	✓	34
C236-(GE)	SEE CG236		24	C321A	145TTGN4337	✓	80	C376	5KC49TN0067	✓	32	C659	5KCR48WN0566Y	✓	30
C237	SEE C237A		54	C322	SEE C322A		80	C380	SEE C380B		56	C660	5KC49TN0568Y	✓	30
C237A	215TTFW14022	✓	54	C322A	145TTGN4338	✓	80	C380B	184TTFW16051	✓	56	C661	5KC46GN0569Y	✓	29
C238	SEE C238B		54	C323	SEE C323A		80	C381	182TTFR4320	✓	56	C662	5KC49SN2418U	✓	30
C238B	184TTFW14021	✓	54	C323A	182TTGN4068	✓	80	C381B	182TTFW16021	✓	56	C663	5KC49NN2419Y	✓	30
C239-(GE)	SEE CG239		25	C324	SEE C324A		80	C381-(GE)	SEE CG381		22	C664	5KC36LN4003Y	✓	29
C242	5KC32GN9	✓	29	C324A	184TTGN4072	✓	80	C382	SEE C382B		56	C683	5KC36LN84X	✓	115
C243	5KC32GN9X	✓	29	C325	SEE C325A		80	C382B	182TTFW16030	✓	56	C702	5KC38RN4153Y	✓	21
C247	5KC32GN13	✓	153	C325A	213TTGN4067	✓	80	C382-(GE)	SEE CG382		171	C703	5KC49PN2520Y	✓	22
C248	5KC49PN3036	✓	29	C326	SEE C326A		80	C383	SEE C383A		56	C704	5KC49PN2521Y	✓	22,168
C250	SEE C250A		53	C326A	215TTGN4065	✓	80	C383A	182TTFW4345	✓	56	C732-(GE)	SEE CG732		115
C250A	145TFFR4378	✓	53	C327	SEE C327A		80	C383B	182TTFW16027	✓	56	C806	5KC49PN0281X	✓	153
C250-(GE)	SEE G1312		29	C327A	254TTGN14042	✓	80	C383-(GE)	SEE CG383		171	C847	5KC37NN115X	✓	115
C251	SEE C251A		53	C328	SEE C328A		80	C384	SEE C384A		56	C855	5KC49SN2156X	✓	31
C251A	---		53	C328A	256TTGN14044	✓	80	C384A	213TTFW16078	✓	56	C878	5KCR49TN2164T	✓	115
C251-(GE)	SEE CG251		29	C328-(GE)	SEE J1025		115,157	C384-(GE)	SEE CG384		171	C1081	5KC39EN2553X	✓	114
C252	SEE C252A		53	C329	5KC37FN65X	✓	115	C385	SEE C385B		56	C1082	5KC39NN2554X	✓	114
C252A	---		53	C330	5KC36JN268X	✓	115,157	C385B	184TTFW16006	✓	56	C1083	5KC33MN2555X	✓	114
C252-(GE)	SEE G1316		29	C331	5KC36JN269X	✓	115	C386	SEE C386B		56	C1084	5KC39SN2810X	✓	114
C253	SEE C253A		54	C332	5KC39NN50X	✓	115,157	C386A	184TTFW4340	✓	56	C1085	5KCR39SN2557X	✓	114
C253A	213TTFW14081		54	C333	5KC39QN3219X	✓	115	C386B	184TTFW16027	✓	56	C1086	5KCR39UN2558X	✓	114
C254	SEE C254A		54	C334	5KC39RN44X	✓	115,157	C387	184TTFR4345	✓	56	C1087	5KC39EN2500X	✓	114
C254A	215TTFW14084		54	C335	5KC39RN45X	✓	115	C387A	184TTFW4345	✓	56	C1088	5KC39NN2501X	✓	114
C254-(GE)	SEE G1330		29	C336	5KC49NN2140X	✓	115,157	C387B	184TTFW16029	✓	56	C1089	5KC33MN2502X	✓	114
C255	SEE C255A		54	C337	5KC49NN2167X	✓	115	C388	SEE C388A		56	C1090	5KC39SN2812X	✓	114
C255A	254TFL14078		54	C338	5KC49TN2141X	✓	115,157	C388A	215TTFW16079	✓	56	C1091	5KCR39SN2504X	✓	114
C255-(GE)	SEE G1331		29	C339	5KC49TN2170X	✓	115	C389	SEE C389A		57	C1092	5KCR39UN2505X	✓	114
C256	SEE C256A		54	C340	5KCR48TN2142T	✓	115,157	C389A	213TTFW16008	✓	57	C1104	SEE C104B		40
C256A	256TFFNA14086		54	C341	5KCR48TN2174T	✓	115	C390	SEE C390A		57	C1105	SEE C105B		40
C257-(GE)	SEE C1333		29	C349	5KC36LN166X	✓	31	C390A	213TTFW16035	✓	57	C1123	SEE C123B		40
C260	SEE C223B		54	C351	5KC49NN2133X	✓	31	C391	213TTFW4345	✓	57	C1152	5KC39QN3220X	✓	24,152
C260-(GE)	SEE CG260		29	C352	5KC49NN2135X	✓	115	C391A	213TTFW16036	✓	57	C1153	5KC49GN0022X	✓	24,152
C261	5KC42GN0014	✓	29	C354	5KC35JN70X	✓	27	C392	SEE C392A		57	C1154	5KC38NN413X	✓	24,152
C262	5KC42GN0014X	✓	29	C355	5KC36LN83	✓	27	C392A	215TTFW16005	✓	57	C1155	5KC38NN410X	✓	24,152
C264	5KC49UN6065	✓	29	C356	5KC36LN83X	✓	27	C393	SEE C393A		57	C1156	5KC46LN0149X	✓	24,152
C268	5KC46PN0015	✓	29	C358	5KC49GN0009		27	C393A	215TTFW16041	✓	57	C1157	5KC39RN383X	✓	24,152
C269	5KC46PN0015X	✓	29	C359	5KC49GN0009X	✓	27	C393-(GE)	SEE CG393		23	C1158	5KC49PN0164X	✓	24,152
C271	5KCR48WN6066	✓	29	C361	SEE C361A		78	C394	215TTFW4345		57	C1159	5KC49RN2152T	✓	25,152
C273	5KC49NN2130X	✓	30	C361A	143TTGN6551	✓	78	C394A	215TTFW16042		57	C1160	5KCR49SN0150X	✓	25,152
C274	5KC49NN2130Y	✓	30	C361-(GE)	SEE CG361		27	C400	145TFFR5382	✓	100	C1161	5KCR49RN2148T	✓	25,152
C275	5KC49TN0034	✓	30	C362	145TTGN4032	✓	78	C401	145TFFR5360	✓	100	C1162	SEE B352		25,152
C276	5KC49TN0034X	✓	30	C362A	145TTGN6536	✓	78	C402	184TTTL7084	✓	100	C1168	5KC36GN2507X	✓	114
C281	145TBFR5337		32	C362-(GE)	SEE CG362		27	C403	145TFFR5359	✓	100	C1169	5KC36MN2508X	✓	114
C281-(GE)	SEE G1376		30	C363	SEE C363A		78	C404	184TTTL7083	✓	100	C1170	5KC38PN2509X	✓	114
C282	145TBFR5305		32	C363A	145TTGN6549	✓	78	C405	182TTTL7034	✓	100	C1171	5KC38SN2510X	✓	114
C282-(GE)	SEE G1377		30	C363-(GE)	SEE CG363		27	C406	184TTTL7041	✓	100	C1172	5KCR39UN2511X	✓	114
C284	145TBFR5306		32	C364	SEE C364A		78	C407	213TTTL7034	✓	100	C1173	5KCR39UN2512X	✓	114
C284-(GE)	SEE G1392		30	C364A	182TTGN6569	✓	78	C408	215TTTL7050	✓	100	C1187	5KC49NN0224X	✓	24
C289	5KC42GN0309X	✓	153	C365	SEE C365A		78	C419	5KC49PN3027X	✓	25,152	C1203	SEE C203B		54
C292	5KC49TN0285X	✓	153	C365A	184TTGN6575	✓	78	C420	5KCR49PN3011	✓	25,152	C1204	SEE C204B		54
C295	5KC49TN0033	✓	30	C366	SEE C366A		78	C431	5KC36LN18	✓	21	C1223	182TTFW7634	✓	54
C297	5KCR48WN0292	✓	30	C366A	213TTGN6528	✓	78	C444	5KC36LN144X	✓	32	C1224	184TTFW8641	✓	54
C301	SEE C301A		80	C366-(GE)	SEE G1511		31	C445	5KC49NN2132X	✓	32	C1238	184TTFW8617	✓	54
C301A	143TTGN4020		80	C367	SEE C367A		78	C446	5KC42GN0018X	✓	31	C1252	5KC49PN6070	✓	21
C302	SEE C302A		80	C367A	215TTGN4028	✓	78	C449	5KC37NN160	✓	23	C1258	5KC49PN6051	✓	24
C302A	145TTGN4022		80	C367-(GE)	SEE G1513		31	C457	5KC37NN14T	✓	24	C1263	5KC48UN6073	✓	21
C303	SEE C303A		80	C368	SEE C368A		78	C459	5KC37MN96	✓	21	C1264	5KC48UN6052	✓	24
C303A	182TTGN4315	✓	80	C368A	182TTGN6536		78	C460	5KC36LN19X	✓	24	C1269	5KC49SN2537Y	✓	28
C304	SEE C304A		80	C368-(GE)	SEE G1515		31	C462	5KC33KN19	✓	29	C1270	5KC49ZN2539Y	✓	28
C304A	184TTGN4313	✓	80	C369	SEE C369A		78	C465	5KC39QN3218X	✓	115	C1273	5KC49SN8060T	✓	140
C305	213TTGS14015	✓	80	C369A	184TTGN6537		78	C466	5KCR49TN2155T	✓	31	C1274	5KCR49TN8058T	✓	140
C306	215TTGS14020	✓	80	C369-(GE)	SEE G1517		31	C474	5KCR49PN3011X	✓	25,152	C1275	5KCR49ZN8061T	✓	140
C307	SEE C307A		80	C370	SEE C370A		78	C475	5KCR49SN3009	✓	25,152	C1285	5KC46JN0722	✓	107



Index

Catalog Number/Model Number

CAT. NO.	MODEL NO.	STOCK	PAGE NO.	CAT. NO.	MODEL NO.	STOCK	PAGE NO.	CAT. NO.	MODEL NO.	STOCK	PAGE NO.	MODEL NO.	CAT. NO.	STOCK	PAGE NO.
C1286	5KC47NN0723	✓	107	C1817	5KC49SN6380X	✓	35	D451	56T11F5325	✓	100	E140	145TTDR4115		120
C1287	SEE N542		107	C1818	5KC49MN6379X	✓	35	D452	56T17F5349	✓	100	E141	145TTDR4121		120
C1288	5KC49QN0724	✓	107	C1904	5KCR49ZN0564Y	✓	101	D453	56T11F5326	✓	100	E142	145TTDR4307		120
C1289	5KC49RN2513	✓	107	C1909	5KCR49ZN0785S	✓	104	D454	56T17F5350	✓	100	E143	145TTDR4110		120
C1290	5KCR48QN0725	✓	107	CG105	5KC35JN27Y	✓	23	D455	56T11F5327	✓	100	E144	145TTDR4025		120
C1291	5KC46GN0075U	✓	102	CG111	5KC37LN91	✓	23	D456	56T17F5357	✓	100	E145	182TTDR4140		120
C1292	5KC46JN0076U	✓	102	CG201	5KC35JN12X	✓	24	D457	56T17F5358	✓	100	E146	182TTDR4146		120
C1293	5KCR49PN0077U	✓	102	CG223	5KC49GN0001X	✓	24	D1113	5KC46LN0158X	✓	24,152	E147	182TTDR4036		120
C1294	5KCR49UN0079U	✓	102	CG230	5KC46LN0158	✓	24,152	E12D4	5KS49HN4077	✓	36	E147A	182TTDW4036		120
C1295	5KCR49WN0295U	✓	102	CG232	5KCR49WN6077	✓	24	E34D4	5KS46MN4078	✓	36	E148A	182TTDW4135	✓	120
C1296	SEE G212		27	CG236	5KCR49PN0155X	✓	24	E001	182TTFC6081	✓	58	E149A	182TTDW4147		120
C1297	SEE G256		27	CG239	5KCR49SN0012X	✓	25	E002	184TTFC6081	✓	59	E150	182TTDR4116		120
C1298	5KC46NN0758Y	✓	21	CG251	5KC32GN19X	✓	29	E003	213TTFC6081	✓	59	E150A	182TTDW4116		120
C1299	5KCR48WN0756Y		22,168	CG260	5KC37RN35	✓	29	E004	215TTFC6081	✓	59	E151	182TTDR4122		120
C1302	5KCR49SN0042S	✓	104	CG361	5KC46LN0159	✓	27	E005	254TTFC6081	✓	59	E152	182TTDR4117		120
C1303	5KCR46NN0264T	✓	104	CG362	5KC46LN0159X	✓	27	E006	256TTFC6081	✓	60	E153A	182TTDW4304	✓	120
C1314	5KCR49PN0492S	✓	104	CG363	5KC49PN0163X	✓	27	E007	284TTFC6081	✓	60	E154	182TTDR4123		120
C1315	5KCR49SN0493S	✓	104	CG381	5KCR49WN0270T	✓	22	E008	286TTFC6081	✓	60	E155	184TTDR4140		120
C1333	5KC49PN6062	✓	29	CG382	5KC35GNA488	✓	171	E009	324TTFC6081	✓	60	E156	184TTDR4146		120
C1336	5KC33FN4180X	✓	115	CG383	5KC35JNA489	✓	171	E010	326TTFC6081	✓	60	E157	184TTDR4141		120
C1380	184TTFW4380	✓	56	CG384	5KC35JNA489Y	✓	171	E011	324TSTFC6006	✓	60	E158A	184TTDW4135	✓	120
C1381	SEE C381B		56	CG393	5KC36MN20	✓	23	E012	364TTFC6081	✓	60	E159	184TTDR4147		120
C1382	SEE C382B		56	CG732	5KC39RN114T	✓	115	E013	326TSTFC6006	✓	60	E160	184TTDR4115		120
C1385	SEE C385B		56	D010	56B34D2029	✓	21,168,174	E014	365TTFC6081	✓	60	E161	184TTDR4121		120
C1404	5KC49UN6067	✓	31	D012	SEE 9035		22,168	E015	364TSTFC6006	✓	60	E162	184TTDR4116		120
C1405	5KC35MN145	✓	32	D013	SEE 9036		22,168	E016	365TSTFC6006	✓	60	E163A	184TTDW4110	✓	120
C1412	5KCR49WN6078		32	D014	SEE 9031		21,168	E095	143TTDR14004		119	E164	184TTDR4122		120
C1419	5KC33FN31	✓	31	D015	SEE 9032		21,168,174	E096	145TTDR4317	✓	119	E165	213TTDW4042		121
C1420	5KC36LN144	✓	32	D017	56B34D5302	✓	22,168	E097	182TTDW14029	✓	120	E166	213TTDW4041		121
C1422	5KC48UN6072	✓	27	D018	SEE C704		22,168	E098	182TTDW4006	✓	120	E167	213TTDW4033		121
C1423	5KC49MN6063		31	D107	48S17D2017	✓	150	E100	143TTDR4035	✓	119	E168	213TTDW4048	✓	121
C1424	5KC49SN2158	✓	31	D110	SEE C1152		24,152	E102	145TTDR4034	✓	119	E169	213TTDW4038		121
C1425	5KC49PN0283	✓	32	D111	56C17D2079	✓	24,152	E104	145TTDR4060	✓	119	E170	213TTDW4009		121
C1458	5KC46GN0251	✓	171	D113	SEE D1113		24,152	E105	145TTDR4303		120	E171	213TTDW4010		121
C1459	5KC46GN0251Y	✓	171	D114	SEE C1158		24,152	E106A	182TTDW4033	✓	120	E172	213TTDW4008		121
C1460	5KC46LN0252	✓	171	D115	56B34D2027	✓	25,152	E107A	182TTDW4002	✓	120	E173	213TTDW4023	✓	121
C1461	5KC46LN0252Y	✓	171	D116	SEE C1161		152	E108	184TTDR4034	✓	120	E174	213TTDW4007		121
C1462	5KC39HN2888X	✓	114	D117	SEE C1155		24,152	E108A	184TTDW4034	✓	120	E175	215TTDW4041		121
C1463	5KC33MN2889X	✓	114	D118	56C34D2106	✓	24,152	E109A	184TTDW14001	✓	120	E176	215TTDW4042		121
C1464	5KC39SN2890X	✓	114	D119	48C17D2055	✓	152	E110	213TTDW4047	✓	121	E177	215TTDW4043		121
C1465	5KCR39SN2891X	✓	114	D127	SEE 4305		150	E111	213TTDW4022	✓	121	E178	215TTDW4048	✓	121
C1466	5KCR39UN2892X	✓	114	D129	SEE 4306		150	E112	215TTDW4047	✓	121	E179	215TTDW4032		121
C1467	5KC37NN3544T	✓	140	D143	48S17D2086	✓	151	E113	215TTDW4022	✓	121	E180	215TTDW4008		121
C1468	5KC49NN2081T	✓	140	D145	SEE H167		151	E114A	254TTDX14062	✓	121	E181	215TTDW4009		121
C1469	5KC49PN0253	✓	171	D149	56S17D2050	✓	151	E115	143TTDR4040		119	E182	215TTDW4010		121
C1474	5KC37LN502Y	✓	21	D162	48S17D2087	✓	151	E116	143TTDR4047		119	E183	215TTDW4023	✓	121
C1475	5KC37NN501Y	✓	21	D163	48S17D2088	✓	151	E117	143TTDR4041		119	E184	215TTDW4007		121
C1477	5KC49PN2144Y	✓	22	D164	SEE 4338		151	E118	143TTDR4034	✓	119	E185	254TTDX4343		121
C1478	5KCR49SN3009X	✓	25,152	D180	48S17D7204		150	E119	143TTDR4046		119	E186	254TTDX4344		121
C1479	5KCR48TN3084X	✓	25,152	D181	48S17D7205		151	E120	143TTDR4016		119	E187	254TTDX4345		121
C1480	5KC49PN0161U	✓	21,168,174	D311	56C34F5301	✓	33	E121	143TTDR4022		119	E188	254TTDX4039	✓	121
C1483	5KC46LN0254X		26	D312	56C34F5302	✓	33	E122	143TTDR4017		119	E190	254TTDX4007		121
C1489	5KC46PN0359Y	✓	171	D313	56C34F5303	✓	33	E123	143TTDR4009	✓	119	E191	254TTDX4006	✓	121
C1801	5KC49MN6384X	✓	34	D314	56B34F5326	✓	33	E124	143TTDR4024		119	E192	254TTDX4019		121
C1802	SEE G650		34	D315	56B34F5327	✓	33	E125	145TTDR4040		119	E193	254TTDX4015		121
C1803	5KC49HN0719X	✓	34	D316	56B34F5328	✓	33	E126	145TTDR4072		119	E194	254TTDX4020		121
C1804	SEE G651		34	D390	56T34T5303	✓	55	E127	145TTDR4041		119	E195	254TTDX4024		121
C1805	SEE G652		34	D391	56T34F5301	✓	55	E128	145TTDR4035	✓	119	E197	256TTDX4075	✓	122
C1806	SEE G653		34	D392	56T34F5302	✓	55	E129	145TTDR4047		119	E198	256TTDX4326		122
C1807	5KC49QN0716X	✓	34	D393	56T34F5303	✓	55	E130	145TTDR4015		119	E199	256TTDX4329		122
C1808	SEE G654		34	D394	56T34F5304	✓	56	E131	145TTDR4021		119	E205	254TTFNA6026	✓	60
C1809	5KC49SN6375X		34	D395	56T34F5305	✓	56	E132	145TTDR4016		119	E206	256TTFNA6026	✓	60
C1810	5KC49QN4559X	✓	34	D396	56T34F5306	✓	56	E133	145TTDR4010	✓	119	E207	284TTFNA6026	✓	60
C1811	SEE G659		34	D400	56C17F5352	✓	99	E134	145TTDR4022		119	E208	286TTFNA6026	✓	60
C1812	SEE G853		35	D401	56C17F5353	✓	99	E135	145TTDR4066		119	E209	324TTF6026	✓	61
C1813	SEE G854		35	D402	56C17F5354	✓	99	E136	145TTDR4046		119	E210	326TTF6026	✓	61
C1814	5KC49HN2509X	✓	35	D403	56C17F5355	✓	99	E137	145TTDR4067		119	E211	364TTF6036	✓	61
C1815	SEE G855		35	D404	56B17F5330	✓	99	E138	145TTDR4051	✓	119	E212	365TTF6036	✓	61
C1816	5KC49QN0718X	✓	35	D450	56T17F5348	✓	100	E139	145TTDR4073		119	E213	405TTF6036	✓	61

Catalog Number/Model Number

CAT. NO.	MODEL NO.	STOCK	PAGE NO.	CAT. NO.	MODEL NO.	STOCK	PAGE NO.	CAT. NO.	MODEL NO.	STOCK	PAGE NO.	CAT. NO.	MODEL NO.	STOCK	PAGE NO.
E214	444TTF6036	✓	61	E284	449TTF6390		62	E386	145TTFN6835		70	E563	286TSTGN6501	✓	83
E215	445TTFN6036	✓	62	E284-(GE)	SEE EG284		32	E388	184TTF66576		70	E564	286TTGN6537	✓	83
E216	182TTTS6001	✓	59	E285	5KCR49UN0108	✓	30	E390	182TTF66501		70	E565	326TTGS6578	✓	83
E218	213TTTS6001	✓	59	E286	5KS49HN4595	✓	108	E392	182TTF66505		70	E566	324TSGS6501	✓	83
E220	254TTFNA6001	✓	60	E287	445TTFN6040		62	E396	213TTF66501		70	E567	324TTGS6529	✓	83
E221	256TTFNA6001	✓	60	E287-(GE)	SEE EG287		108	E400	326TTF66580		71	E568	SEE E568A		83
E222	284TSTFNA6001	✓	60	E288	SEE N320		108	E401	SEE E401A		71	E568A	364TTGS16577	✓	83
E223	286TSTFNA6001	✓	60	E289	445TTFN6087		62	E401A	364TTF66585		71	E569	326TSGS6501	✓	83
E224	324TSTFS6001	✓	61	E290	SEE N310		108	E402	SEE E402A		71	E570	326TTGS6532	✓	83
E225	326TSTFS6001	✓	61	E291	449TTF616334		62	E402A	365TTF66592		71	E571	365TTGS16577	✓	83
E226	364TSTFS6001	✓	61	E292	449TTF66065		62	E403	404TTF66592		72	E572	364TSGS6506	✓	83
E227	365TSTFS6001	✓	61	E293	449TTF616333		62	E404	405TTF66587		72	E573	SEE E573A		83
E228	405TSTFS6001	✓	61	E294	SEE N642		109	E405	SEE E405A		72	E573A	364TTGS16536	✓	83
E229	444TSTFS6001	✓	61	E295	SEE N644		109	E405A	444TTFN16582		72	E574	404TTGS6588	✓	83
E230	445TSTFN6001	✓	62	E296	SEE N646		109	E406	445TTFN6590		72	E575	365TSGS16503	✓	83
E235	254TTFNA6076	✓	59	E297-(GE)	SEE EG297		109	E407	445TTFN6591		72	E576	SEE E576A		83
E236	256TTFNA6076	✓	60	E302-(GE)	SEE N566		110	E408	449TTF66582		72	E576A	365TTGS16540	✓	83
E237	284TTFNA6076	✓	60	E303	182TTTS6030	✓	59	E448	445TTFN6587	✓	72	E577	405TTGS6589	✓	83
E238	286TTFNA6076	✓	60	E303-(GE)	SEE N567		110	E449	445TSTFN6505	✓	72	E578	405TSGS6503		84
E239	324TTF6076	✓	60	E304-(GE)	SEE N622		110	E450	445TTFN6540		72	E580A	444TTGN16580	✓	84
E240	326TTF6076	✓	61	E305-(GE)	SEE N569		110	E453	326TSTFS6536		71	E582A	444TTGN16532	✓	84
E241	SEE E241A		61	E306	215TTF6030		60	E454	364TSTFS6526		71	E583	445TTGN6597		84
E241A	364TTF616083	✓	61	E306-(GE)	SEE N599		110	E455	365TSTFS6526	✓	72	E584	445TSTGN16505		84
E242	SEE E242A		61	E307	254TTFNA6030	✓	60	E456	405TSTFS6526	✓	72	E585	445TTGN6542	✓	84
E242A	365TTF616083	✓	61	E307-(GE)	SEE EG307		110	E457	444TSTFS6526	✓	72	E588	445TTGN6538		84
E243	404TTF6086	✓	61	E308	256TTFNA6030	✓	60	E458	445TSTFN6526	✓	72	E591	449TTGS16537		84
E244	405TTF6086	✓	61	E308-(GE)	SEE N601		110	E459	445TSTFN6528	✓	72	E594	405TTGS6548	✓	84
E246	445TTFN6086	✓	61	E309	284TTFNA6030	✓	60	E461	143TTN6563	✓	69	E595	449TSGS14003		84
E247	445TTFN6038	✓	62	E309-(GE)	SEE N602		110	E462	145TTN6584		69	E601	182TTTS6501	✓	70
E250	5KCR46JN0083Y	✓	28	E310	286TTFNA6030	✓	60	E463	143TTN6502		69	E602	184TTFS6501	✓	70
E251	5KCR46JN0084	✓	27	E310-(GE)	SEE N626A		110	E464	145TTN6834	✓	69	E603	213TTTS6501	✓	70
E252	5KCR46JN0083X	✓	28	E311	324TTF6030	✓	61	E465	182TTTS6578		69	E604	215TTF6501	✓	70
E253	5KCR46JN0085	✓	21	E311-(GE)	SEE EG311		110	E466	145TTN6521		69	E605	254TTFNA6501	✓	71
E254	5KCR46JN0086X	✓	24	E312	326TTF6030	✓	61	E467	145TTN6835	✓	70	E606	256TTFNA6501	✓	71
E255	5KCR46JN0087Y	✓	32	E312-(GE)	SEE N605		110	E468	184TTTS6582	✓	70	E607	284TSTFNA6501	✓	71
E256	5KCR46JN0088	✓	31	E313	364TTF6040	✓	61	E470	182TTTS6538	✓	70	E608	286TSTFNA6501	✓	71
E257	5KCR46JN0087X	✓	32	E314	405TTF6040	✓	61	E471	213TTF66594	✓	70	E609	324TSTFS6501	✓	71
E258	5KCR46JN0089	✓	29	E315	365TTF6040	✓	61	E472	184TTF66810	✓	70	E610	326TSTFS6501	✓	71
E259	5KCR46MN0090Y	✓	28	E316	444TTF6044		61	E473	184TTF66844	✓	70	E611	364TSTFS6501	✓	71
E260	5KCR46MN0091	✓	27	E317	445TTFN6037		62	E474	215TTF66881	✓	70	E612	365TSTFS6501	✓	72
E261	5KCR46MN0090X	✓	28	E319	324TSTFS6005		61	E475	213TTTS6502	✓	70	E613	405TSTFS6501	✓	72
E262	5KCR46MN0092	✓	21	E320	326TSTFS6005		61	E476	213TTF66531	✓	70	E614	444TSTFS6501	✓	72
E263	5KCR46MN0054X	✓	24	E321	364TSTFS6005		61	E477	254TTFNA6590	✓	70	E615	445TSTFN6501	✓	72
E264	5KCR46MN0055Y	✓	32	E322	365TSTFS6002		61	E478	215TTF66807	✓	70	E616	182TTTS6526	✓	70
E265	5KCR46MN0093	✓	31	E323	405TSTFS6005		61	E479	215TTF66527	✓	70	E617	184TTF66526	✓	70
E266	5KCR46MN0055X	✓	32	E324	444TSTFS16002		61	E480	256TTFNA6596	✓	70	E618	213TTF66526	✓	70
E267	5KCR46MN0094	✓	29	E326	445TTFN6039		62	E481	254TTFNA6515	✓	71	E619	215TTF66526	✓	70
E268	5KCR49PN0095Y	✓	28	E327	444TTFN16577		72	E482	254TTFNA6529	✓	71	E620	254TTFNA6526	✓	71
E269	5KCR49PN0096	✓	27	E328	444TTFN6086	✓	61	E483	284TTFNA6876	✓	71	E621	256TTFNA6526	✓	71
E270	5KCR49PN0095X	✓	28	E342	445TSTFN16004	✓	62	E484	256TTFNA6523	✓	71	E622	284TTFNA6526	✓	71
E271	449TSTFS6003		62	E345	449TTF616534		73	E485	256TTFNA6529	✓	71	E623	286TTFNA6526	✓	71
E271-(GE)	SEE EG271		21	E351	143TTN6001	✓	58	E486	286TTFNA6876		71	E624	324TTF66526	✓	71
E272	449TSTFS6002		62	E353	145TTN6001	✓	59	E488	284TTFNA6837	✓	71	E625	326TTF66526	✓	71
E272-(GE)	SEE EG272		24	E362	---		73	E490	286TSTFNA6804	✓	71	E626	364TTF66536	✓	71
E273	449TSTFS6001		62	E363	5013LSTFS6595		73	E491	286TTFNA6570	✓	71	E627	365TTF66536	✓	72
E273-(GE)	SEE EG273		32	E364	5011LSTFS16031		73	E493	405TSTFS6502		72	E628	405TTF66536	✓	72
E274	5KCR49PN0100	✓	31	E365	---		73	E494	444TSTFS6505		72	E629	444TTF66536	✓	72
E275	5KCR49PN0099X	✓	32	E366	5011LSTFS16033		73	E495	445TSTFN6502		72	E630	445TTFN6536	✓	72
E276	449TTF6038		62	E369	---		73	E496	445TSTFN6506		72	E631	445TTFN6538	✓	72
E276-(GE)	SEE EG276		29	E373	143TTFN6576		69	E500	254TTGN6576	✓	83	E632	182TTTS6576	✓	69
E277	449TTF6037		62	E374	143TTFN6526		69	E501	256TTGN6576	✓	83	E633	184TTTS6576	✓	70
E277-(GE)	SEE EG277		28	E375	143TTFN6563		69	E502	254TTGN6507	✓	83	E634	213TTF66576	✓	70
E278	SEE G256		27	E376	143TTFN16539		69	E503	254TTGN6531	✓	83	E635	215TTF66576	✓	70
E280	5KCR48UN0104	✓	21	E377	143TTFN6501		69	E504	284TTGN6576	✓	83	E636	254TTFNA6576	✓	70
E281	5KCR48UN0105X	✓	24	E378	143TTFN6502		69	E505	256TTGN16509	✓	83	E637	256TTFNA6576	✓	70
E282	449TTF6088	✓	62	E379	143TTFN6505		69	E506	256TTGN6531	✓	83	E638	284TTFNA6576	✓	71
E282-(GE)	SEE EG282		32	E380	182TTF6576		69	E507	286TTGN16577	✓	83	E639	286TTFNA6576	✓	71
E283	449TTF6087		62	E382	145TTFN6501		69	E546	284TSTGN6503	✓	83	E640	324TTF66576	✓	71
E283-(GE)	SEE EG283		31	E383	145TTFN6521		69	E547	284TTGN6533	✓	83	E641	326TTF66576	✓	71



Index

Catalog Number/Model Number

CAT. NO.	MODEL NO.	STOCK	PAGE NO.	CAT. NO.	MODEL NO.	STOCK	PAGE NO.	CAT. NO.	MODEL NO.	STOCK	PAGE NO.	MODEL NO.	CAT. NO.	STOCK	PAGE NO.
E642	SEE E942A		71	E715	143TTDR5347	✓	36	E781	SEE E781A		44	E824	143TTFR4028	✓	47
E642A	364TTFS16584	✓	71	E716	SEE U759		42	E781A	405TSTDS16038	✓	44	E825	143TTTN4028		50
E643	SEE E643A		71	E717	SEE U760		42	E782	SEE E782C		44	E826	143TTTC4026	✓	50
E643A	365TTFS16591	✓	71	E718	SEE E1930		42	E782C	365TSTDS16041	✓	44	E827	SEE E2126		58
E644	404TTFS6586	✓	72	E719	SEE E1931		42	E783	143TTDR5313	✓	37	E828	143TTTN4030	✓	50
E645	405TTFS6586	✓	72	E720	SEE U763		43	E783A	143TTDR6313	✓	37	E829	145TTTN4076	✓	50
E646	SEE E646A		72	E721	SEE U765		43	E784	SEE U247		42	E830	143TTFR4003		48
E646A	444TTFN16581	✓	72	E722	SEE U767		43	E785	145TTDR4078		37	E831	143TTTN4003		50
E647	445TTFN6586	✓	72	E723	SEE U769		43	E786	256TTDX4013	✓	38	E832	SEE E2103		58
E648	143TTTN6576	✓	69	E725A	SEE U773		43	E787	324TTDP4030	✓	39	E833	143TTTN4001	✓	50
E649	143TTTN6526	✓	69	E725B	SEE U773		43	E788	215TTDW4003	✓	38	E834	SEE E2128		58
E650	145TTTN6576	✓	69	E726	SEE U775		43	E789	SEE E789A		43	E835	143TTTN4005		50
E651	143TTTN6501	✓	69	E727	SEE U777		43	E789A	326TSTDP16032	✓	43	E836	145TTFR4029	✓	48
E652	145TTTN6526	✓	69	E728	SEE U265		42	E790	326TTDP4046		39	E837	145TTTC4026	✓	50
E653	145TTTN6501	✓	69	E729	SEE E1729		37	E791	SEE E791A		39	E838	145TTFR4038	✓	48
E654	145TTTN6527	✓	70	E730	SEE U1267		42	E791A	326TSTDR16034	✓	43	E839	145TTTN4035	✓	50
E655	184TTFS6505	✓	70	E731	SEE U268		42	E792	SEE E792A		44	E840	145TTFR4005		48
E656	213TTTS6505	✓	70	E732	SEE U269		42	E792A	444TSTDS16038	✓	44	E841	145TTTN4003		50
E657	215TTFS6505		70	E733	SEE U254		43	E793	SEE E793A		43	E842	145TTTN4001	✓	50
E658	254TTFNA6503		71	E734	SEE U255		43	E793A	284TSTDN16031		43	E843	145TTFR4007		48
E659	256TTFNA6503	✓	71	E735	SEE U256		43	E794	SEE E794A		43	E844	145TTTN4005		50
E660	284TSTFNA6502		71	E736	SEE U257		43	E794A	286TSTDN16036		43	E845	145TTFR4032	✓	48
E662	324TSTFS6505		71	E737	SEE U798		43	E795	SEE U273		44	E846	145TTTC4027	✓	50
E663	326TSTFS6502		71	E738	SEE U799		43	E796	SEE U274		44	E847	145TTFR4039	✓	48
E664	364TSTFS6505		71	E739	364TTDC4036	✓	39	E797	SEE U275		44	E848	145TTTN4040	✓	50
E665	365TSTFS6502	✓	72	E740	SEE U1783		44	E798	143TTDR4006		37	E849	SEE E849A		59
E666	143TTTN6530	✓	69	E741	SEE E922		44	E798A	143TTDR16005	✓	42	E849A	184TTC6077	✓	59
E667	145TTTN6529		69	E742	405TTDS4036	✓	39	E799	SEE E1799		37	E851	143TTTN6505		69
E668	145TTTN6530	✓	70	E743	444TTDS4036	✓	39	E800	284TTFPA4030	✓	51	E852	145TTTN6505		69
E669	182TTTS6530	✓	70	E744	SEE E925		44	E800A	284TTC6031	✓	60	E853	182TTTS6505		70
E670	184TTFS6530	✓	70	E745	445TTDS4037		39	E801	SEE E801A		61	E854	449TTFS6540	✓	72
E671	213TTFS6530	✓	70	E746	SEE U1927		43	E801A	326TSTFC6036	✓	61	E856	449TTFS6564	✓	72
E672	215TTFS6530	✓	70	E747	SEE U1928		43	E802	SEE E802A		61	E901	143TTDR5348	✓	36
E673	254TTFNA6528	✓	71	E748	404TTDS4086	✓	39	E802A	364TSTFC6026	✓	61	E902	145TTDR5632	✓	37
E674	256TTFNA6528	✓	71	E749	SEE U271		44	E803	404TTFS4086	✓	51	E903	145TTDR5633	✓	37
E675	284TTFNA6527	✓	71	E750	SEE U272		44	E804	SEE E804A		61	E906	213TTDBA4028	✓	38
E676	286TTFNA6527	✓	71	E753	SEE U1784		44	E804A	365TSTFC6026	✓	61	E907	215TTDW4028	✓	38
E677	324TTFS6527	✓	71	E754	404TSTDS4001	✓	39	E805	365TTFS4040	✓	52	E908	254TTDX4028	✓	38
E678	326TTFS6527	✓	71	E755	405TSTDS4001	✓	39	E805A	365TTC6041	✓	61	E909	256TTDX4027	✓	38
E679	364TTFS6537	✓	71	E756	444TSTDS4001	✓	39	E806	SEE E244		61	E910	284TTDP4029	✓	38
E680	365TTFS6537		72	E757	445TSTDS4001	✓	39	E807	SEE E228		61	E911	286TTDP4027	✓	39
E681	405TTFS6538	✓	72	E758	213TTDW4030	✓	38	E808	SEE E808A		61	E912	143TTDR5351	✓	37
E682	445TTFN6537		72	E759	215TTDW4030	✓	38	E808A	405TSTFS16033	✓	61	E912A	143TTDR16037	✓	42
E683	215TTFS6580		70	E760	254TTDX4030	✓	38	E809	SEE E328		61	E913	SEE E913A		42
E684	254TTFNA6578		70	E761	256TTDX4032	✓	38	E810	444TSTFS4026	✓	52	E913A	145TTDR16061	✓	42
E685	256TTFNA6578		70	E762	284TTDP4035	✓	38	E810A	444TSTFN16033	✓	61	E914	145TTDR5665	✓	37
E687	449TTFS6588	✓	72	E762A	284TTDC6029	✓	43	E811	SEE E811A		62	E914A	145TTDR16062	✓	37,42
E688	449TTFS6587		72	E763	286TTDP4034		39	E811A	445TSTFN6026	✓	62	E915B	182TTDW16029	✓	42
E690	449TTFS6538	✓	72	E763A	286TTDC6029	✓	43	E812	445TSTFN4005	✓	52	E916B	184TTDR16040	✓	42
E691	449TTFS6537	✓	73	E764	324TTDP4028		39	E813	SEE E813A		62	E917	143TTDR4005		37
E692	449TTFS6536	✓	73	E764A	324TTDC6029	✓	43	E813A	445TSTFN16033	✓	62	E918	184TTDR4178		37
E694	284TTFNA6580		71	E765	326TTDP4048	✓	39	E814	SEE E814A		62	E919	145TTDR4003		37
E695	286TTFNA6580		71	E765A	326TTDC6029	✓	43	E814A	449TTFS16094	✓	62	E922	404TTDS6060	✓	44
E696	324TTFS6577		71	E766	364TTDS4040		39	E815	324TTFPA4030	✓	51	E923	405TTDS6060	✓	44
E697	444TTFS6540		72	E766A	365TTDS16067		43	E815A	324TTC6031	✓	60	E924	444TTDS6060	✓	44
E698	449TSTFS6502	✓	73	E767	365TTDS4041		39	E816	SEE E816A		61	E925	445TTDS6060	✓	44
E699	449TSTFS6503	✓	72	E767A	365TTDS16064		44	E816A	324TSTFC6036	✓	61	E932	145TTDR4105		37
E702	SEE U246		42	E768	364TSTDC4026	✓	39	E817	286TTFPA4030	✓	51	E932A	145TTDR16010	✓	42
E704	182TTDR4001	✓	38	E768C	365TSTDS16042	✓	43	E817A	286TTC6031	✓	61	E933	182TTDR4104		38
E705	SEE U249A		43	E769	449TSTFS6501	✓	73	E818	SEE E818A		60	E934	145TTDR4080		37
E706	SEE U764		43	E770	449TTFS6530	✓	72	E818A	286TSTFC6036	✓	60	E934A	145TTDR16077	✓	42
E707	SEE U766		43	E771	449TTFS6528	✓	72	E819	286TSTFPA4005		51	E935	215TTDW4078	✓	38
E708	SEE U768		43	E772	449TTFS6527		73	E819A	286TSTFC6006	✓	60	E936	SEE U280		42
E709	SEE U770		43	E773	449TTFS6578	✓	72	E820	SEE E820A		60	E937	SEE E937A		38
E710	SEE U772		43	E774	449TTFS6577		72	E820A	324TTC6077	✓	60	E937A	184TTDR4003		38
E711	SEE U774		43	E776	449TTFS16553		73	E821	215TTFW4005		49	E938	184TTDR4105		38
E712	SEE U776		43	E777	—		73	E822	215TTFW4028	✓	49	E938A	184TTDR16027	✓	43
E713	SEE U778		43	E780	SEE E780A		44	E823	SEE E823A		58	E939	213TTDW4003		38
E714	364TSTDS4001	✓	39	E780A	404TSTDS16036	✓	44	E823A	182TTC6077	✓	58	E950	SEE E2101		58

Catalog Number/Model Number

CAT. NO.	MODEL NO.	STOCK	PAGE NO.	CAT. NO.	MODEL NO.	STOCK	PAGE NO.	CAT. NO.	MODEL NO.	STOCK	PAGE NO.	CAT. NO.	MODEL NO.	STOCK	PAGE NO.
E951	SEE E2104		58	E1727	SEE U777		43	E2124	256TFL16033	✓	60	F102	56C17F5325	✓	101
E952	SEE E2107		59	E1729	SEE U1266		42	E2125	56T34F16020		58	F103	56C17F5326	✓	101
E953	SEE E2110		59	E1730	SEE U1267		42	E2126	143TTFR16040	✓	58	F104	56C17F5327	✓	101
E954	SEE E2113		59	E1739	364TTDCA4036	✓	39	E2127	145TTFR16080		58	F105	56B17F5307	✓	101
E955	SEE E2116		59	E1740	365TTDCA4036	✓	39	E2128	143TTFR16020		58	F107	SEE C1468		140
E957	SEE E957A		61	E1768	364TSTDCA4026	✓	39	E2129	145TTFR16040	✓	58	F108	SEE C1273		140
E957A	365TTFC6037	✓	61	E1782	365TSTDCA4026	✓	39	E2130	182TTFW16080	✓	58	F109	SEE C1274		140
E958	SEE E289		62	E1799	182TTDW4083	✓	37	E2131	145TTFR16020		59	F110	SEE C1275		140
E959	SEE E213		61	E1904	182TTDW4027	✓	38	E2132	145TTFR16045	✓	59	F120	SEE C1467		140
E960	SEE E960A		61	E1905	184TTDW4027	✓	38	E2133	184TTFW16081		59	F131	56C17F5358	✓	32,101
E960A	364TSTFC6002	✓	61	E1915	182TTDW4030	✓	38	E2134	182TTFW16020	✓	59	F132	56C17F5912	✓	32,101
E961C	284TTFC6027	✓	60	E1916	184TTDW4030	✓	38	E2135	182TTFW16040	✓	59	F133	56C17F5913	✓	32,101
E962	SEE E962B		61	E1930	182TTDW6030	✓	42	E2136	213TTFW16081		59	F134	56C17F5914	✓	32,101
E962B	326TTFC6027	✓	61	E1931	184TTDW6031	✓	42	E2137	184TTFW16020	✓	59	F135	56B17F5584	✓	32,101
E963	SEE E2112		59	E1955	SEE E2116		59	E2138	184TTFW16040	✓	59	F201	SEE HG646		102
E964	SEE E964A		60	E1956	215TTFBA4026	✓	49	E2139	215TTFW16080		59	F202	SEE C1292		102
E964A	286TSTFC6002	✓	60	E1961	SEE E961C		60	E2140	213TTFW16020		59	F203	SEE C1293		102
E965	SEE E2124		60	E1962	SEE E962B		61	E2141	213TTFW16040	✓	59	F204	56C17F5357	✓	102
E966	SEE E966A		61	E1963	SEE E2112		59	E2142	254TFL16077		59	F205	56B17F5331	✓	102
E966A	326TTFC6077	✓	61	E1967	SEE E2109		59	E2143	215TTFW16020		60	F780	5KCP49UN9837S	✓	104
E967	SEE E2109		59	E1982	SEE E2105		58	E2144	215TTFW16040	✓	60	F781	5KCP49UN9838S	✓	104
E968	SEE E968A		60	E1983	SEE E983B		60	E2145	256TFL16077		60	F1201	48C17F11005	✓	102
E968A	286TTFC6077	✓	60	E1984	SEE E984B		61	E2146	254TFL16020		60	F1202	48C17F11006	✓	102
E969	SEE E2118		60	E1985	SEE E985B		61	E2147	254TFL16040	✓	60	F1203	48C17F11007	✓	102
E970	SEE E2114		59	E1995	SEE E2108		59	E2148	256TFL16020		60	F1204	56C17F15537	✓	102
E971	SEE E971A		61	E2000	56T34F5940	✓	62	E2149	256TFL16040	✓	60	F1205	56B17F15516	✓	102
E971A	324TSTFC6002	✓	61	E2001	143TTFR5642	✓	62	E2150	56T34F16001		58	G044	48T17D2000	✓	36
E972	SEE E2115		59	E2002	145TTFR6078	✓	62	E2151	143TTFR16038	✓	58	G046	56T17D2128		36
E973	SEE E2120		60	E2003	143TTFR5582	✓	62	E2152	145TTFR15581		58	G047	56T17D2095	✓	36
E974	SEE E2123		60	E2004	145TTFR6033	✓	62	E2153	143TTFR16001		58	G061	56T11D5301		36
E975	284TSTFPA4001	✓	51	E2005	182TTFW6076	✓	62	E2154	145TTFR16038	✓	58	G062	56T17D2114	✓	36
E975A	284TSTFC6002	✓	60	E2006	145TTFR3002	✓	62	E2155	182TTFW16082		58	G063	56T17D2094	✓	36
E976	SEE E976A		61	E2007	145TTFR6035	✓	62	E2156	145TTFR16001		59	G065	56T17D2112	✓	36
E976A	326TSTFC6002	✓	61	E2008	184TTFW6076	✓	62	E2157	145TTFR16039	✓	59	G067	56T11D5302	✓	36
E977	SEE E2121		60	E2009A	182TTFR6001	✓	62	E2158	184TTFW16079		59	G076	SEE C147		21
E978	284TTFC4076	✓	51	E2009	182TTFW6001	✓	62	E2159	182TTFW16002	✓	59	G078	48C17D2034	✓	21
E978A	284TTFC6077	✓	60	E2010	182TTFW6026	✓	62	E2160	182TTFW16038	✓	59	G080	56T34D5301	✓	36
E979	SEE E2102		58	E2011	213TTFW6076	✓	62	E2161	213TTFW16082		59	G082	56T17D2111	✓	36
E980	SEE E2111		59	E2012	184TTFW6001	✓	62	E2162	184TTFW16002	✓	59	G084	56T17D2093	✓	36
E981	SEE E230		62	E2013	184TTFW6026	✓	62	E2163	184TTFW16038	✓	59	G086	56T17D2110	✓	36
E982	SEE E2105		58	E2014	215TTFW6076	✓	62	E2164	215TTFW16081		59	G088	56T11D5303	✓	36
E983	SEE E983B		60	E2015	213TTFW6001	✓	62	EG271	5KCR49PN0097	✓	21	G091	48C34D2025		21
E983B	286TTFC6027	✓	60	E2016	213TTFW6026	✓	62	EG272	5KCR49PN0098X	✓	24	G093	SEE C158		21
E984	SEE E984B		61	E2018	215TTFW6001	✓	62	EG273	5KCR49PN0099Y	✓	32	G094	SEE C159		21
E984B	324TTFC6027	✓	61	E2019	215TTFW6026	✓	62	EG276	5KCR49PN0101	✓	29	G095	56C17D2010	✓	21
E985	SEE E985B		61	E2100	56T34F15940	✓	58	EG277	5KCR48UN0102Y	✓	28	G096	SEE C1252		21
E985B	364TTFC6037	✓	61	E2101	143TTFR15642	✓	58	EG282	5KCR49UN0106Y	✓	32	G098	SEE G1098		21
E986	SEE E215		62	E2102	145TTFR16078	✓	58	EG283	5KCR49UN0107	✓	31	G100	56T17D2101	✓	154
E987	SEE E214		61	E2103	143TTFR15582	✓	58	EG284	5KCR49UN0106X	✓	32	G101	SEE K1410		154
E988	SEE E988A		61	E2104	145TTFR16033	✓	58	EG287	5KS49MN4608	✓	108	G106	56T17D2104	✓	154
E988A	364TTFC6087	✓	61	E2105	182TTFW16076	✓	58	EG297	5KS49UN8379	✓	109	G107	SEE K1408		154
E989	SEE E247		62	E2106	145TTFR13002	✓	59	EG302	SEE N566		110	G109	SEE K381		154
E991	SEE E991A	✓	61	E2107	145TTFR16035	✓	59	EG303	SEE N567		110	G114	SEE G1114		24,152
E991A	365TSTFC6003	✓	61	E2108	184TTFW16076	✓	59	EG304	SEE N622		110	G115	SEE G1115		24,152
E992	444TSTFS4001	✓	52	E2109	182TTFW16001	✓	59	EG305	SEE N569		110	G120	SEE K278		154
E993	SEE E993A		61	E2110	182TTFW16026	✓	59	EG306	SEE N599		110	G122	56T17D5329	✓	154
E993A	365TTFC6087	✓	61	E2111	213TTFW16076	✓	59	EG307	5KS49PN4602	✓	110	G126	SEE K1415		154
E994	SEE E2106		59	E2112	184TTFW16001	✓	59	EG308	SEE N601		110	G127	56T17D5332	✓	154
E995	184TTFR4076	✓	48	E2113	184TTFW16026	✓	59	EG309	SEE N602		110	G128	SEE K1418		154
E996	SEE E2122		60	E2114	215TTFW16076	✓	59	EG310	SEE N626A		110	G135	56C17D2088	✓	24,152
E997	SEE E2147		60	E2115	213TTFW16001	✓	59	EG311	5KS49UN4598	✓	110	G140	56T17D5345	✓	154
E998	256TFL14030		49	E2116	213TTFW16026	✓	59	EG312	SEE N605		110	G141	56T17D5346	✓	154
E999	SEE E999A		60	E2117	254TFL16076	✓	59	F10E1	5KC49TN0063Y	✓	101	G142	56T17D5347	✓	154
E999A	284TSTFC6036	✓	60	E2118	215TTFW16001	✓	60	F12E1	5KC46GN0050Y	✓	101	G143	56T17D5348	✓	154
E1704	SEE U1248		42	E2119	215TTFW16026	✓	60	F13E1	5KC42GN0051Y	✓	101	G144	56T17D5349	✓	154
E1705	SEE U249A		43	E2120	256TFL16076	✓	60	F15E1	5KCR48WN0292Y		101	G145	56T17D5350	✓	154
E1719	SEE E1931		42	E2121	254TFL16001	✓	60	F34E1	5KC46PN0062Y	✓	101	G151	56C17D2025	✓	24,152
E1724	SEE U771		43	E2122	254TFL16026	✓	60	F100	5KCR48WN0273Y	✓	101	G156	56B17D2012	✓	24,152
E1726	SEE U775		43	E2123	256TFL16002	✓	60	F101	56C17F5324	✓	101	G161	56T17D5701		154



Index

Catalog Number/Model Number

CAT. NO.	MODEL NO.	STOCK	PAGE NO.	CAT. NO.	MODEL NO.	STOCK	PAGE NO.	CAT. NO.	MODEL NO.	STOCK	PAGE NO.	MODEL NO.	CAT. NO.	STOCK	PAGE NO.
G162	56T17D2121	✓	154	G347	56T17F5302	✓	47	G569	56T34F5308		55	G876	56C17G5327	✓	35
G165	SEE K544		154	G348	SEE K424		47	G570	56C17F5320	✓	33	G905	56T17D5336	✓	36
G166	SEE K546		154	G350	SEE C264		29	G571	56C17F5321	✓	33	G908	56T17D5339	✓	36
G167	SEE K1409		154	G352	56C34F5308	✓	29	G572	56C17F5322	✓	33	G910	SEE C167		21
G168	SEE K279		154	G354	SEE C268		29	G573	56C17F5323	✓	33	G911	SEE C168		21
G169	SEE K280		154	G355	SEE C269		29	G574	56B17F5305	✓	33	G912	SEE C169		21,168
G180	SEE K1411		154	G356	56C17F5308	✓	29	G575	56B17F5306	✓	33	G913	SEE C1263		21
G181	SEE K518		154	G357	SEE C271		29	G576	56C11F5303	✓	33	G915	56C34D2100	✓	21
G182	SEE K519		154	G359	56C34F5310	✓	30	G577	56C11F5302	✓	33	G917	SEE C175		21
G183	SEE K1413		154	G360	SEE K165		47	G578	56B11F5303	✓	33	G918	SEE C176		21
G184	SEE K520		154	G363	56T34F5336		48	G579	56B11F5302	✓	33	G919	56B17D2010	✓	21
G185	SEE K549		154	G365	SEE K167		48	G580	56T17F5305	✓	55	G921	56T17D5342	✓	36
G186	SEE K1416		154	G368	56T34F5337		48	G581	56T17F5321	✓	55	G923	56T17D5344	✓	37
G201	SEE K248		40	G369	SEE K1492		48	G582	56T17F5322	✓	55	G930	SEE C178		21
G203	SEE K249		40	G371	SEE C275		30	G583	56T17F5323	✓	55	G932	SEE C179		21
G205	56T34D5327		40	G372	SEE C276		30	G584	56T17F5324	✓	56	G934	SEE C181		21
G207	SEE K250		40	G373	56C17F5311	✓	30,175	G585	56T17F5325	✓	56	G935	SEE C182		21
G212	56C17D2084	✓	27	G374	56B34F5320	✓	30	G586	56T11F5311	✓	55	G936	SEE C1480		21,168,174
G216	56C34D2117	✓	27	G376	SEE G1376		30	G587	56T11F5310	✓	55	G937	56B34D2026	✓	22
G221	SEE K251		40	G377	SEE G1377		30	G588	56T11F5309	✓	55	G939	SEE C185		22
G225	SEE K521		40	G378	56B17F5302	✓	30,175	G589	56T11F5308	✓	55	G950	SEE C186		22
G229	SEE K644		40	G379	56C34F5309	✓	29,175	G590	56T17F5355	✓	56	G951	56C17D5308	✓	22,168
G230	56C17D2085	✓	27	G380	56C17F5957		175	G591	56T17F5356		56	G952	SEE C187		22
G232	56C34D2108	✓	27	G381	56C17F5955	✓	175	G639	56C17E5314	✓	34	G958	56B17D5323	✓	174
G234	56C17D2044	✓	27	G382	56C17F5956	✓	175	G646	56T17E5308	✓	79	G961	56T17D2118	✓	154
G238	56C34D2101	✓	27	G383	SEE K166		48	G647	56T17E5309	✓	79	G962	56T17D2119	✓	154
G242	56T17D2115	✓	40	G385	56T34F5338		48	G648	56T34G5303		79	G963	56T17D2120	✓	154
G243	56T17D2116	✓	40	G387	56T17F5327		48	G649	56T17G5312	✓	79	G964	56T17D2117		154
G244	56T17D2127		40	G390	56C34F5311	✓	30,175	G650	56C11G5306	✓	34	G965	56T17D5357		154
G245	SEE K247		40	G391	56B34F5321	✓	30	G651	56C17G5315	✓	34	G966	SEE K277		154
G248	SEE K1299		40	G392	SEE G1392		30	G652	56C11G5307	✓	34	G967	56T17D5385		154
G250	56B17D2011	✓	27	G393	56C34F5307	✓	29	G653	56C34G5308	✓	34	G976	56B34D5304		174
G254	56B34D2031	✓	27	G396	56B17F5310	✓	175	G654	56C17G5316	✓	34	G979	56B17D5319		174
G256	56C17D5310	✓	27	G502	SEE K253		53	G655	56B11G5301	✓	34	G987	56B34D2021		174
G258	56B34D2023		27	G503	SEE K522		53	G656	56C34G5309		34	G996	56B34D5334		174
G270	56C17D5311	✓	27	G507	SEE K254		53	G657	56C17G5317	✓	34	G1098	5KC36JN266	✓	21
G272	56B34D5319	✓	27	G508	SEE K469		53	G658	56C34G5310		34	G1114	5KC35JN7	✓	24,152
G274	56B17D5303	✓	27	G511	SEE G1511		31	G659	56C17G5318	✓	34	G1115	5KC35JN7X	✓	24,152
G278	56C11D5304	✓	27,155	G513	SEE G1513		31	G660	56T34G5304		79	G1312	5KC32GN19	✓	29
G289	56T34D5339		40	G514	56C34F5322		31	G661	56T17G5313	✓	79	G1316	5KC49MN6061	✓	29
G290	56B17D5328		174	G515	SEE G1515		31	G662	56T34G5305		79	G1330	5KC35MN43	✓	29
G294	56B34D5307		174	G516	56C34F5323	✓	31	G663	56T17G5314	✓	79	G1331	5KC35MN43X	✓	29
G301	SEE K321		47	G517	SEE G1517		31	G664	56T17E5314		79	G1340	5K36PN251	✓	47
G303	SEE K154		47	G518	56C34F5324	✓	31	G665	56T17E5315		79	G1376	5KCR48WN0273	✓	30
G304	56T17F2043	✓	47	G519	SEE G1519		31	G666	56T17G5321	✓	79	G1377	5KCR48WN0273X	✓	30
G306	SEE K155		47	G522	SEE K255		53	G667	56T17G5322	✓	79	G1392	5KCR49TN2139U	✓	30
G308	56T34F5328	✓	47	G523	SEE K523		53	G668	56T17G5323	✓	79	G1511	5KC32GN25	✓	31
G309	56T34F5333	✓	47	G527	SEE K256		53	G827	56T17E5310	✓	80	G1513	5KC35MN73	✓	31
G312	SEE G1312		29	G528	SEE K524		53	G828	56T17E5311	✓	80	G1515	5KC42GN0018	✓	31
G314	56C17F2052	✓	29	G530	SEE C1424		31	G829	56T17G5315	✓	80	G1517	5KC46PN0032	✓	31
G316	SEE G1316		29	G531	SEE G1531		31	G840	56T17G5316	✓	80	G1519	5KC49TN0035	✓	31
G321	SEE K158		47	G533	56B34F5319	✓	31	G841	56T17G5317	✓	80	G1531	5KCR48WN0294	✓	31
G322	SEE K426		47	G534	SEE C1419		31	G842	56T17E5312		80	GT0005	182TTDB6076	✓	45
G324	SEE K159		47	G541	SEE K257		53	G843	56T17E5313	✓	80	GT0008	184TTDB6076	✓	45
G326	SEE K160		47	G544	SEE K1491		53	G844	56T17G5318		80	GT0010	182TTDB6026	✓	45
G327	56T34F5334	✓	47	G547	SEE K252		53	G845	56T17G5319	✓	80	GT0011	213TTDB6076	✓	45
G328	56T17F2045		47	G548	56T17F5320		53	G846	56T17G5320	✓	80	GT0012	182TTDB6001	✓	45
G329	SEE K161		47	G549	56T17F5329		53	G852	56C17E5319	✓	35	GT0013	184TTDB6026	✓	45
G330	SEE G1330		29	G550	SEE C1405		32	G853	56C17G5320	✓	35	GT0014	215TTDB6076	✓	45
G331	SEE G1331		29	G551	SEE C375		32	G854	56C34G5311		35	GT0015	184TTDB6001	✓	45
G332	56C17F2049	✓	29	G552	SEE C1245		32	G855	56C17G5321	✓	35	GT0016	213TTDB6026	✓	45
G333	SEE C1333		29	G553	SEE C376		32	G857	56C17G5322	✓	35	GT0017	254TTDCA6076	✓	45
G337	SEE C261		29	G559	SEE C1420		32	G858	56C34G5316		35	GT0018	213TTDB6001	✓	45
G338	SEE C262		29	G560	SEE K1322		55	G870	56C17G5323	✓	35	GT0019	215TTDB6026	✓	45
G339	56C17F2051	✓	29	G561	SEE K1324		55	G871	56C17G5324	✓	35	GT0020	256TTDCA6076	✓	45
G340	SEE G1340		47	G562	SEE K258		55	G872	56C17G5328	✓	35	GT0021	215TTDB6001	✓	45
G342	SEE K162		47	G563	SEE K259		55	G873	56C34G5314	✓	35	GT0022	254TTDCA6026	✓	45
G344	SEE K163		47	G564	SEE K260		56	G874	56C17G5326	✓	35	GT0023	284TTDCA6076	✓	45
G345	56T34F5335		47	G565	56T17F2051		55	G875	56C34G5315		35	GT0024	254TTDCA6001	✓	45

Catalog Number/Model Number

CAT. NO.	MODEL NO.	STOCK	PAGE NO.	CAT. NO.	MODEL NO.	STOCK	PAGE NO.	CAT. NO.	MODEL NO.	STOCK	PAGE NO.	CAT. NO.	MODEL NO.	STOCK	PAGE NO.
GT0025	256TTDCA6026	✓	45	GT0519	215TTDB6033	✓	123	GT1113	184TTFC6030	✓	63	GT1228	284TTFCA6028	✓	67
GT0026	286TTDCA6076	✓	45	GT0521	215TTDB6008	✓	123	GT1114	215TTFC6080	✓	63	GT1230	286TTSTFCA6003	✓	67
GT0027	256TTDCA6001	✓	45	GT0522	254TTDCA6033	✓	123	GT1115	213TTFC6005	✓	63	GT1231	286TTFCA6028	✓	67
GT0028	284TTDCA6026	✓	45	GT0524	254TTDCA6008	✓	124	GT1116	213TTFC6030	✓	63	GT1233	324TTSTFCA6003	✓	67
GT0029	324TTDCA6076	✓	45	GT0525	256TTDCA6033	✓	124	GT1117	254TTFCA6080	✓	63	GT1234	324TTFCA6028	✓	67
GT0030	284TTDCA6001	✓	45	GT0527	256TTDCA6008	✓	124	GT1118	215TTFC6005	✓	63	GT1236	326TTSTFCA6003	✓	67
GT0031	286TTDCA6026	✓	45	GT0528	284TTDCA6033	✓	124	GT1119	215TTFC6030	✓	63	GT1237	326TTFCA6028	✓	67
GT0032	326TTDCA6076	✓	45	GT0530	284TTDCA6008	✓	124	GT1120	256TTFCA6080	✓	63	GT1239	364TTSTFCA6003	✓	67
GT0033	286TTDCA6001	✓	45	GT0531	286TTDCA6033	✓	124	GT1121	254TTFCA6005	✓	63	GT1240	364TTFCA6038	✓	67
GT0034	324TTDCA6026	✓	45	GT0533	286TTDCA6008	✓	124	GT1122	254TTFCA6030	✓	63	GT1242	365TTSTFCA6003	✓	67
GT0035	364TTDCA6086	✓	45	GT0534	324TTDCA6033	✓	124	GT1123	284TTFCA6080	✓	63	GT1243	365TTFCA6038	✓	67
GT0036	324TTDCA6001	✓	45	GT0536	324TTDCA6008	✓	124	GT1124	256TTFCA6005	✓	64	GT1245	405TTSTFC6003	✓	67
GT0037	326TTDCA6026	✓	45	GT0537	326TTDCA6033	✓	124	GT1125	256TTFCA6030	✓	64	GT1246	405TTFC6038	✓	67
GT0038	365TTDCA6086	✓	45	GT1005	182TTFC6076	✓	63	GT1126	286TTFCA6080	✓	64	GT1305	182TTFB6079	✓	66
GT0039	326TTDCA6001	✓	45	GT1008	184TTFC6076	✓	63	GT1127	284TTSTFCA6005	✓	64	GT1308	184TTFB6079	✓	66
GT0040	364TTDCA6086	✓	45	GT1009	182TTFC6001	✓	63	GT1128	284TTFCA6030	✓	64	GT1309	182TTFB6004	✓	66
GT0041	404TTDCA6086	✓	45	GT1010	182TTFC6026	✓	63	GT1129	324TTFCA6080	✓	64	GT1310	182TTFB6029	✓	66
GT0042	364TTDCA6001	✓	46	GT1011	213TTFC6076	✓	63	GT1130	286TTSTFCA6005	✓	64	GT1311	213TTFBA6079	✓	66
GT0043	365TTDCA6086	✓	46	GT1012	184TTFC6001	✓	63	GT1131	286TTFCA6030	✓	64	GT1312	184TTFB6004	✓	66
GT0044	405TTDCA6086	✓	46	GT1013	184TTFC6026	✓	63	GT1132	326TTFCA6080	✓	64	GT1313	184TTFB6029	✓	66
GT0045	365TTDCA6001	✓	46	GT1014	215TTFC6076	✓	63	GT1133	324TTSTFCA6005	✓	64	GT1314	215TTFBA6079	✓	66
GT0046	404TTDCA6086	✓	46	GT1015	213TTFC6001	✓	63	GT1134	324TTFCA6030	✓	64	GT1315	213TTFBA6004	✓	66
GT0047	444TTDCA6077	✓	46	GT1016	213TTFC6026	✓	63	GT1135	364TTFCA6080	✓	64	GT1316	213TTFBA6029	✓	66
GT0048	404TTDCA6001	✓	46	GT1017	254TTFCA6076	✓	63	GT1136	326TTSTFCA6005	✓	64	GT1318	215TTFBA6004	✓	66
GT0049	405TTDCA6086	✓	46	GT1018	215TTFC6001	✓	63	GT1137	326TTFCA6030	✓	64	GT1319	215TTFBA6029	✓	66
GT0050	445TTDCA6076	✓	46	GT1019	215TTFC6026	✓	63	GT1138	365TTFCA6080	✓	64	GT1401	143TTFR16039	✓	66
GT0051	405TTDCA6007	✓	46	GT1020	256TTFCA6076	✓	63	GT1139	364TTSTFCA6005	✓	64	GT1403	143TTFR16003	✓	66
GT0052	444TTDCA6086	✓	46	GT1021	254TTFCA6001	✓	63	GT1140	364TTFCA6040	✓	64	GT1404	145TTFR16046	✓	66
GT0053	447TTDCA6077	✓	46	GT1022	254TTFCA6026	✓	63	GT1141	404TTFC6080	✓	64	GT1406	145TTFR16005	✓	66
GT0054	444TTDCA6003	✓	46	GT1023	284TTFCA6076	✓	63	GT1142	365TTSTFCA6002	✓	64	GT1407	145TTFR16047	✓	66
GT0055	445TTDCA6086	✓	46	GT1024	256TTFCA6001	✓	64	GT1143	365TTFCA6040	✓	64	GT1409	182TTFB6007	✓	66
GT0056	449TTDCA6076	✓	46	GT1025	256TTFCA6026	✓	64	GT1144	405TTFC6080	✓	64	GT1410	182TTFB6032	✓	66
GT0401	143TTDR6030	✓	123	GT1026	286TTFCA6076	✓	64	GT1145	405TTSTFC6005	✓	65	GT1412	184TTFB6007	✓	66
GT0403	143TTDR6007	✓	123	GT1027	284TTSTFCA6001	✓	64	GT1146	405TTFC6040	✓	65	GT1413	184TTFB6032	✓	66
GT0404	145TTDR6034	✓	123	GT1028	284TTFCA6026	✓	64	GT1147	444TTFC6080	✓	65	GT1415	213TTFBA6007	✓	66
GT0406	145TTDR6007	✓	123	GT1029	324TTFCA6076	✓	64	GT1148	444TTSTFC16002	✓	65	GT1416	213TTFBA6032	✓	66
GT0407	145TTDR6036	✓	123	GT1030	286TTSTFCA6001	✓	64	GT1149	444TTFC6044	✓	65	GT1418	215TTFBA6007	✓	67
GT0409	145TTDR6013	✓	123	GT1031	286TTFCA6026	✓	64	GT1150	445TTFC6080	✓	65	GT1419	215TTFBA6032	✓	67
GT0410	182TTDB6032	✓	123	GT1032	326TTFCA6076	✓	64	GT1151	445TTSTFC6005	✓	65	GT1421	254TTFCA6007	✓	67
GT0412	182TTDB6007	✓	123	GT1033	324TTSTFCA6001	✓	64	GT1152	445TTFC6037	✓	65	GT1422	254TTFCA6032	✓	67
GT0413	184TTDB6032	✓	123	GT1034	324TTFCA6026	✓	64	GT1153	447TTFC6080	✓	65	GT2401	143TTDR16048	✓	131
GT0415	184TTDB6007	✓	123	GT1035	364TTFCA6086	✓	64	GT1154	447TTSTFC6005	✓	65	GT2501	143TTDR16040	✓	131
GT0416	213TTDB6032	✓	123	GT1036	326TTSTFCA6001	✓	64	GT1155	447TTFC6039	✓	65	GT2403	143TTDR16015	✓	131
GT0418	213TTDB6007	✓	123	GT1037	326TTFCA6026	✓	64	GT1156	449TTFC6080	✓	65	GT2503	143TTDR16006	✓	131
GT0419	215TTDB6032	✓	123	GT1038	365TTFCA6086	✓	64	GT1201	143TTFR6032	✓	66	GT2404	145TTDR16330	✓	131
GT0421	215TTDB6007	✓	123	GT1039	364TTSTFCA6001	✓	64	GT1202	145TTFR16079	✓	66	GT2504	145TTDR16327	✓	131
GT0422	254TTDCA6032	✓	123	GT1040	364TTFCA6036	✓	64	GT1203	143TTFR6010	✓	66	GT2406	145TTDR16020	✓	131
GT0424	254TTDCA6007	✓	124	GT1041	404TTFC6086	✓	64	GT1204	145TTFR6058	✓	66	GT2506	145TTDR16017	✓	131
GT0425	256TTDCA6032	✓	124	GT1042	365TTSTFCA6001	✓	64	GT1205	182TTFB6078	✓	66	GT2407	145TTDR16333	✓	131
GT0427	256TTDCA6007	✓	124	GT1043	365TTFCA6036	✓	64	GT1206	145TTFR6009	✓	66	GT2507	145TTDR16339	✓	131
GT0428	284TTDCA6032	✓	124	GT1044	405TTFC6086	✓	64	GT1207	145TTFR6040	✓	66	GT2409	145TTDR16301	✓	131
GT0430	284TTDCA6007	✓	124	GT1045	405TTSTFCA6001	✓	65	GT1208	184TTFB6078	✓	66	GT2509	145TTDR16303	✓	131
GT0431	286TTDCA6032	✓	124	GT1046	405TTFC6036	✓	65	GT1209	182TTFB6003	✓	66	GT2412	182TTDB6037	✓	131
GT0433	286TTDCA6007	✓	124	GT1047	444TTFC6086	✓	65	GT1210	182TTFB6028	✓	66	GT2512	182TTDB6038	✓	131
GT0434	324TTDCA6032	✓	124	GT1048	444TTSTFCA6001	✓	65	GT1211	213TTFBA6078	✓	66	GT2412	182TTDB6012	✓	131
GT0436	324TTDCA6007	✓	124	GT1049	444TTFC6036	✓	65	GT1212	184TTFB6003	✓	66	GT2512	182TTDB6013	✓	131
GT0437	326TTDCA6032	✓	124	GT1050	445TTFC6086	✓	65	GT1213	184TTFB6028	✓	66	GT2413	184TTDB6037	✓	131
GT0501	143TTDR6031	✓	123	GT1051	445TTSTFCA6001	✓	65	GT1214	215TTFBA6078	✓	66	GT2513	184TTDB6038	✓	131
GT0503	143TTDR6008	✓	123	GT1052	445TTFC6036	✓	65	GT1215	213TTFBA6003	✓	66	GT2415	184TTDB6012	✓	131
GT0504	145TTDR6031	✓	123	GT1053	447TTFC6087	✓	65	GT1216	213TTFBA6028	✓	66	GT2515	184TTDB6013	✓	131
GT0506	145TTDR6004	✓	123	GT1054	447TTSTFC16004	✓	65	GT1217	254TTFCA6078	✓	66	GT2416	213TTDB6037	✓	131
GT0507	145TTDR6030	✓	123	GT1055	447TTFC6038	✓	65	GT1218	215TTFBA6003	✓	67	GT2516	213TTDB6038	✓	131
GT0509	145TTDR6006	✓	123	GT1056	449TTFC6088	✓	65	GT1219	215TTFBA6028	✓	67	GT2418	213TTDB6012	✓	131
GT0510	182TTDB6033	✓	123	GT1105	182TTFC6080	✓	63	GT1220	256TTFCA6078	✓	67	GT2518	213TTDB6013	✓	131
GT0512	182TTDB6008	✓	123	GT1108	184TTFC6080	✓	63	GT1221	254TTFCA6003	✓	67	GT2419	215TTDB6037	✓	131
GT0513	184TTDB6033	✓	123	GT1109	182TTFC6005	✓	63	GT1222	254TTFCA6028	✓	67	GT2519	215TTDB6038	✓	131
GT0515	184TTDB6008	✓	123	GT1110	182TTFC6030	✓	63	GT1224	256TTFCA6003	✓	67	GT2421	215TTDB6012	✓	131
GT0516	213TTDB6033	✓	123	GT1111	213TTFC6080	✓	63	GT1225	256TTFCA6028	✓	67	GT2521	215TTDB6013	✓	131
GT0518	213TTDB6008	✓	123	GT1112	184TTFC6005	✓	63	GT1227	284TTSTFCA6003	✓	67	GT2422	254TTDCA6037	✓	131



Index

Catalog Number/Model Number

CAT. NO.	MODEL NO.	STOCK	PAGE NO.	CAT. NO.	MODEL NO.	STOCK	PAGE NO.	CAT. NO.	MODEL NO.	STOCK	PAGE NO.	MODEL NO.	CAT. NO.	STOCK	PAGE NO.
GT2522	254TTDCA6038	✓	131	H178-(GE)	SEE HG178		153	H280	5KH49UN3024X	✓	155	H684	5KH36MNA445X	✓	113
GT2424	254TTDCA6012	✓	132	H180	143TDR5401		36	H282	5KH49PN3042X	✓	155	H685	5KH39EN2887X	✓	114
GT2524	254TTDCA6013	✓	132	H181	145TDR5401	✓	36	H286	5KH36MN3106	✓	151	H689	5KH35JN603X	✓	23
GT2425	256TTDCA6037	✓	132	H181-(GE)	SEE B1502		153	H287	5KH36KN112X	✓	155	H690-(GE)	SEE HG690		25
GT2525	256TTDCA6038	✓	132	H182A	182TTDW7101		37	H288	5KH49SN3023X	✓	155	H691	5KH36LN488X	✓	23
GT2427	256TTDCA6012	✓	132	H182-(GE)	SEE HG182		153	H290	5KH36MN137	✓	155	H692-(GE)	SEE HG692		26
GT2527	256TTDCA6013	✓	132	H183A	184TTDW7101		37	H291	5KH32EN72X	✓	153	H693	5KH46JN0329X	✓	26
GT2428	284TTDCA6037	✓	132	H184	SEE H184A		37	H293	5KH46PN3034	✓	153	H694-(GE)	SEE HG694		151
GT2528	284TTDCA6038	✓	132	H184A	213TTDW14102		37	H296	5KH49SN3046	✓	150	H695-(GE)	SEE HG695		150
GT2432	284TTDCA6012	✓	132	H185	SEE H185A		38	H298	5KH48UN6054X	✓	151	H696	5KH36LNA504	✓	23
GT2532	284TTDCA6013	✓	132	H185A	215TTDW14110		38	H300	5KH49SN3048	✓	150	H697-(GE)	SEE X1903		104
GT2431	286TTDCA6037	✓	132	H185-(GE)	SEE B1504		153	H344	5KH36KNB633X	✓	113	H698-(GE)	SEE X1904		104
GT2531	286TTDCA6038	✓	132	H186	SEE 186A		38	H350	143TTGN7076	✓	82	H699-(GE)	SEE HG699		104
GT2433	286TTDCA6012	✓	132	H186A	254TTDX14104	✓	38	H439	5KH39EN2552X	✓	114	H700	143TTFR5376	✓	47
GT2533	286TTDCA6013	✓	132	H186-(GE)	SEE HG186		153	H440	5KH39EN2506X	✓	114	H700-(GE)	SEE HG700		151
GT2434	324TTDCA6037	✓	132	H187	256TTDX7101	✓	38	H450-(GE)	SEE HG450		113	H701-(GE)	SEE HG701		150
GT2534	324TTDCA6038	✓	132	H187A	256TTDN14102	✓	37	H451	5KH32GNB813X	✓	113	H703-(GE)	SEE HG703		151
GT2436	324TTDCA6012	✓	132	H187-(GE)	SEE B1507		153	H454	5KH32ENB168X	✓	34	H704-(GE)	SEE HG704		150
GT2536	324TTDCA6013	✓	132	H188	SEE H188A		38	H455-(GE)	SEE HG455		34	H705-(GE)	SEE HG705		151
GT2437	326TTDCA6037	✓	132	H188A	284TTDN14102		38	H456-(GE)	SEE HG456		34	H706-(GE)	SEE HG706		151
GT2537	326TTDCA6038	✓	132	H188-(GE)	SEE HG188		153	H457	143TTFN8076	✓	50	H710-(GE)	SEE HG710		26
H112	5KH37PN39	✓	150	H189	SEE H189A		38	H458-(GE)	SEE HG458		34	H711-(GE)	SEE HG711		151
H113-(GE)	SEE HG113		150	H189A	286TTDN14101		38	H502	449TTGS7068		84	H712	5KH32GNB815X	✓	113
H114	5KH35FN124	✓	150	H189-(GE)	SEE HG189		153	H503	449TTGS7037		84	H714-(GE)	SEE HG714		113
H115-(GE)	SEE HG115		150	H190	5KH49MN3035	✓	153	H504	449TTGS7036		84	H715-(GE)	SEE HG715		151
H116	5KH32EN66	✓	29	H191	SEE H191A		38	H513	SEE E595		84	H716-(GE)	SEE HG716		159
H120-(GE)	SEE HG120		29	H191A	326TTDR14105		38	H580	SEE E595		84	H717-(GE)	SEE HG717		159
H121-(GE)	SEE HG121		29	H191-(GE)	SEE HG191		153	H581	SEE 502		84	H803	56T17D5398	✓	38
H123-(GE)	SEE HG123		29	H193	447STDN7003	✓	39,132	H601	143TTDR5327	✓	36	H804	SEE X920		167
H124-(GE)	SEE HG124		29	H195	5KH32GN42	✓	104	H604	SEE E902		37	H805	SEE X921		167
H130	5KH39QN6632	✓	151	H196-(GE)	SEE HG196		104	H607	SEE E903		37	H806	SEE X922		167
H131	5KH39QN9631T	✓	151	H197	5KH35MN132	✓	104	H613	SEE E1905		38	H812	447TSTDN7026	✓	39,132
H133	5KH39QN9642T	✓	151	H198	5KH35MN132S	✓	104	H615	SEE E937A		38	H813	447TSTDN7027	✓	39,132
H134	5KH32FN3122	✓	104	H203	5KH36PN106	✓	104	H616	SEE E906		38	H814	447TSTDN7028	✓	39,132
H135	5KH32FN3122S	✓	104	H204	5KH32GN142	✓	155	H619	SEE E907		38	H815	SEE H815A		39,132
H136	5KH49MN6057	✓	104	H205	5KH37PN37	✓	155	H620	5KH49PN3043	✓	150	H815A	449TSTDN14033		39,132
H137	5KH49MN6057S	✓	104	H206	5KH36KN112	✓	155	H621	SEE E788		38	H816	449TSTDN7027		39,132
H138-(GE)	SEE HG138		104	H207	5KH46MN3041	✓	155	H621-(GE)	SEE HG621		151	H817	447TSTDN7005	✓	39,132
H139	5KH33JN3121S	✓	104	H208	5KH32DN111	✓	155	H622	SEE E908		38	H818	449TSTDN7001	✓	39,132
H140-(GE)	SEE HG140		104	H209	5KH37PN36	✓	155	H623	SEE U646A		49	H819	SEE H819A		39,132
H141-(GE)	SEE HG141		104	H210	5KH37PN36X	✓	155	H625	SEE E909		39	H819A	449TSTDN14005	✓	39,132
H142-(GE)	SEE HG142		104	H212	5KH33FN77	✓	155	H627	256TTDX7024	✓	38	H820	449TTDN7086		39
H143-(GE)	SEE HG143		104	H213	5KH33FN77X	✓	155	H628	284TTDP7644	✓	38	H821	SEE H821A		39
H150	143TTDR5376	✓	36	H214	5KH46MN6071	✓	155	H631	SEE U901		39	H821A	449TTDN14078		39
H152-(GE)	SEE HG152		150	H215	5KH46MN6071X	✓	155	H632	SEE E911		39	H822	SEE H822A		39
H154-(GE)	SEE HG154		150	H217	5KH35JN121	✓	155	H636	324TTDP7649	✓	39	H822A	447TTDN14087		39
H155-(GE)	SEE HG155		150	H218	5KH35JN121X	✓	155	H641	5KH39CN5501X	✓	113	H891	5KC49LN6386X	✓	34
H156-(GE)	SEE HG156		150	H219	5KH49PN6069	✓	155	H642	5KH39CN5504X	✓	113	H901	5KH32DNA612	✓	22
H157	5KH32DN3085X	✓	150	H221	5KH48UN6074	✓	155	H645	5KH39QN8B10	✓	25	H902	5KH32DNA612X	✓	22
H158	5KH37PN41	✓	150	H222	5KH49PN3047	✓	155	H646-(GE)	SEE HG646		102	H903	5KH32FNA611	✓	22
H159	5KH37PN41X	✓	150	H223	5KH37PN40	✓	155	H647	5KHC39QN9584X	✓	104	H904	5KH32FNA611X	✓	22
H160	5KH32FN3083	✓	150	H224	5KH49SN3049	✓	155	H648-(GE)	SEE HG648		104	H905	5KH36JNA769	✓	22
H161-(GE)	SEE HG161		150	H225	5KH46MN3040	✓	155	H649	5KHC39QN9575T	✓	104	H906	5KH36JNA769X	✓	22
H162	5KH46MN6053	✓	150	H226	5KH49PN3042	✓	155	H664	SEE E824		47	H907	5KH37NNA768	✓	22
H163	5KH46MN6053X	✓	150	H229	5KH35HN9	✓	23	H665	145TTFR5328	✓	48	H908	5KH37NNA768X	✓	22
H164	5KH32JN3128	✓	151	H230	5KH39QN9091		23	H666	145TTFR5330	✓	48	H912	5KH32DNA700		150
H165	5KH32JN3128X	✓	151	H233	5KH36PN109	✓	153	H668	SEE H1668		49	H913	5KH32DNA700X		150
H166	5KH35JN26	✓	151	H234	5KH39QN9105X	✓	153	H669	213TTFW7028	✓	49	H914	SEE H160		150
H167	5KH35JN26X	✓	151	H236	5KH35MN56X	✓	153	H670	SEE E822		49	H915	5KH33FNA722X	✓	150
H168	5KH49PN6055	✓	151	H239	5KH33FN6	✓	21	H673	5KH33KN5594	✓	26	H917	5KH35JNA723X		151
H169	5KH36KN114	✓	150	H243	5KH32GN68X	✓	29	H674	5KH35JNA231	✓	26	H919	5KH36MNA735X		151
H170	5KH36KN114X	✓	150	H244	5KH32EN124	✓	31	H675	5KH33FNA230	✓	25	H926	5KH36MNB637X	✓	113
H171	5KH37PN33	✓	150	H247	5KH42JN0328S	✓	104	H676	5KH35GNA229	✓	23	H950	5KH140DFK11X	✓	113
H172	5KH37PN33X	✓	150	H248	5KH36MN3106X	✓	151	H679	SEE E1799		37	H951	5KH140DFK17X	✓	113
H173	5KH46MN3025	✓	151	H274	256TTFL15027		49	H679-(GE)	SEE HG679		113	H952	145TTDR5647		176
H174	5KH46MN3025X	✓	151	H275	5KH49PN3045	✓	151	H680-(GE)	SEE HG680		113	H953	182TTDR8353		176
H175	5KH49PN3026	✓	151	H276	5KH42JN0328	✓	104	H681-(GE)	SEE HG681		113	H954	184TTDR9040	✓	176
H176	5KH49PN3026X	✓	151	H277	5KH33KN20S	✓	104	H682	5KH32ENA443X	✓	113	H955	213TTDW7053		176
H178	447TSTDN7001	✓	39,132	H278	5KH37PN37X	✓	155	H683	5KH33GNA444X	✓	113	H956	215TTDW7053	✓	176

Catalog Number/Model Number

CAT. NO.	MODEL NO.	STOCK	PAGE NO.	CAT. NO.	MODEL NO.	STOCK	PAGE NO.	CAT. NO.	MODEL NO.	STOCK	PAGE NO.	CAT. NO.	MODEL NO.	STOCK	PAGE NO.
H957	254TTDX8338	✓	176	I115	215TBDW7026	✓	22,168	J034	SEE C331	✓	115	K121	SEE K000	✓	36
H1613	SEE E1905		38	I116	215TBDW7028	✓	22,168	J035	SEE C333	✓	115	K122	5K46MN4072	✓	36
H1688	184TTFW7727	✓	49	I117	213TCDW7026		22	J036	SEE C335	✓	115	K125	SEE K022	✓	37
HG113	5KH37PN39X	✓	150	I118	SEE C193		22	J037	SEE C337	✓	115	K126	SEE K025	✓	37
HG115	5KH35FN124X	✓	150	I119	184TBDR7375	✓	168,174	J038	SEE C339	✓	115	K136	SEE C1157	✓	24,152
HG120	5KH32FN3123	✓	29	I127	145TBDR5337	✓	22,168,174	J039	SEE C341	✓	115	K151	5K32GN30	✓	47
HG121	5KH32FN3123X	✓	29	I128	184TBDR7631	✓	174	J040	SEE K748	✓	116	K152	56B34D5320	✓	25,152
HG123	5KH33FN85	✓	29	I128A	184TBDW7631	✓	174	J041	SEE K217	✓	116	K153	5K33FN30	✓	47
HG124	5KH33FN85X	✓	29	I130	SEE I130A		174	J042	SEE KG219	✓	116	K154	5K49FN4136	✓	47
HG138	5KH33JN3121	✓	104	I130A	184TBDW7630	✓	174	J043	SEE K221	✓	116	K155	5K36PN30	✓	47
HG140	5KH36NN37	✓	104	I131	184TBDR7632	✓	174	J044	SEE K223	✓	116	K158	5K35MNB117	✓	47
HG141	5KH36NN37S	✓	104	I131A	184TBDW7632	✓	174	J045	SEE K225	✓	116	K159	5K49MN6079	✓	47
HG142	5KH49PN6056	✓	104	I141	182TCDR17079		21	J046	SEE K227	✓	116	K160	5K37NN30	✓	47
HG143	5KH42GN0337	✓	104	I142	184TCDR7076		22	J047	56T34D5368	✓	116	K161	5K36PNB111	✓	47
HG152	5KH32GN140X	✓	150	I143	213TCDW7076		22	J048	56T34D5367	✓	116	K162	5K46PN6082	✓	47
HG154	5KH36KN113X	✓	150	I144	215TBDW7079		22	J049	56T34D5365	✓	116	K163	5K38RN30	✓	47
HG155	5KH46MN3021X	✓	150	I145	145TBDR5303		22	J050	56T34D5366	✓	116	K164	5K49MN4105	✓	47
HG156	5KH32DN3085	✓	150	I146	145TCDR5331	✓	25,152	J051	56T34D5369	✓	116	K165	5K49UN6085	✓	47
HG161	5KH32FN3083X	✓	150	I147	145TBDR5345	✓	25,152	J052	56T34D5370	✓	116	K166	5K46KN2175	✓	48
HG178	5KH32EN79	✓	153	I201	145TBFR5327	✓	30	J053	56T34D5371	✓	116	K167	5K49SN4118	✓	48
HG182	5KH49MN6060	✓	153	I204	145TBFR5301		30	J054	56C34D2118	✓	115	K194	5K33KN92	✓	47
HG196	5KH46PN6059	✓	153	I205	145TBFR5302		30	J055	56C34D2119	✓	115	K196	5K49FN4129	✓	47
HG188	5KH49UN6064	✓	153	I206	182TBFR5301	✓	30	J056	56C34D2120	✓	115	K197	5K42HN4109	✓	47
HG189	5KH36PN108	✓	153	I210	SEE C295		30	J057	56C34D2121	✓	115	K198	5K49PN4113	✓	47
HG191	5KH46PN3033	✓	153	I211	SEE C297		30	J058	56B34D2033	✓	115	K212	56B34D2018		174
HG196	5KH32GN42S	✓	104	I212	182TBFR5326	✓	30	J059	56B34D5341	✓	115	K215-(GE)	SEE KG215	✓	40,116,157
HG450	5KH32GNB812X	✓	113	I213	SEE I213A		30	J060	56T34T5308		117	K216	5K36JN57	✓	40,116,157
HG455	5KH36NNB166X	✓	34	I213A	184TBFW17044	✓	30	J061	56T34F5342	✓	117	K217	5K36JN56	✓	116
HG456	5KH35LNB164X	✓	34	I214	184TBFW7726	✓	30	J062	56T34F5343	✓	117	K218	5K37MN37	✓	40,116,157
HG458	5KH36PNB171X	✓	34	I214A	184TBFW7726	✓	30	J063	56T34F5344	✓	117	K219	56B34D5336	✓	174
HG621	5KH49PN6055X	✓	151	I215	215TBFW7026	✓	30	J064	56T34F5345	✓	117	K219-(GE)	SEE KG219		116
HG646	5KH39QN9508Y	✓	102	I216	213TBFW7026	✓	30	J065	56T34F5346	✓	117	K220	5K38PN47	✓	40,116,157
HG648	5KHC39QN9581T	✓	104	I217	215TBFW7027	✓	30	J066	56T34F5347	✓	117	K221	5K38PN48	✓	116
HG679	5KH32DN5597X	✓	113	I220	143TBFR5301	✓	30	J1025	5K37FN71X	✓	115,157	K222	5K46KN2173	✓	40,116,157
HG680	5KH32FN5598X	✓	113	I221	145TBFR5303	✓	30	K000	56T34D5302	✓	36	K223	5K46KN2172	✓	116
HG681	5KH32GNB814X	✓	113	I223	SEE I223A		30	K003	56T17D2113	✓	36	K224	5K49NN2180	✓	40,116,157
HG690	5KH35JN602X	✓	25	I223A	184TBFW7701	✓	30	K004	56T17D2092	✓	36	K225	5K49NN2178	✓	116
HG692	5KH36LN489X	✓	26	I224	213TBFW7001	✓	30	K007	56T11D5304	✓	37	K226	5K48TN2182	✓	40,116,157
HG694	5KH39QN9767X	✓	151	I225	215TBFW7001	✓	30	K009	56T34D5303	✓	37	K227	5K48TN2181	✓	116
HG695	5KH37PNA233	✓	150	I305	184TBDR7628		174	K016	56B17D56	✓	168,174	K228	SEE P101		53,117
HG699	5KH49PN6056S	✓	104	I308	184TBDR7634		174	K022	56T17D5309	✓	37	K229	SEE P102		53,117
HG700	5KHC37NNA167T	✓	151	I311	145TBFR5333		175	K025	56T34D5304	✓	37	K230	5K35JN47	✓	117
HG701	5KH32DN5618X	✓	150	I314	SEE I314A		32,101,175	K027	56T34D5300		36	K231	SEE P103		53,117
HG703	5KH35MNA519T	✓	151	I314A	184TBFW7041	✓	32,101,175	K032	56C17E5302		34	K232	56B17D5322	✓	174
HG704	5KH35MNA568T	✓	150	I315	SEE I315A		32,101,175	K033	56C11G5303	✓	34	K232-(GE)	SEE KG232		117
HG705	5KH46NN3039T	✓	151	I315A	184TBFW7034	✓	32,101,175	K037	56C17G5308		34	K233	SEE P104		53,117
HG706	5KH37PNA569T	✓	151	I502	143TTGR16026	✓	79	K041	56T17D5310	✓	37	K234	56C17D2114		28
HG710	5KH33JNA511T		26	I503	143TTGR16030		79	K048	56T34D5340		37	K234-(GE)	SEE KG234		117
HG711	5KH32HN5620T	✓	151	I504	145TTGR16076	✓	79	K049	56T17D2130	✓	37	K235	56C17D2115	✓	28
HG714	5KH37PNA479X	✓	113	I505	145TTGR16080		79	K061	56T17D5369	✓	37	K235-(GE)	SEE KG235		53
HG715	5KH38SNA731T	✓	151	I506	143TTGR16001	✓	79	K062	56T17D5370	✓	37	K236	SEE E261		28
HG716	5KH36DNA780X	✓	159	I507	143TTGR16005	✓	79	K063	56T17D3301	✓	36	K236-(GE)	SEE KG236		117
HG717	5KH37GNA782X	✓	159	I508	145TTGR16038	✓	79	K064	56T17D3302	✓	37	K237	SEE E270		28
I101	143TCDR5303		22	I509	145TTGR16030	✓	79	K065	56T17D3303	✓	37	K237-(GE)	SEE KG237		53
I102	145TBDR5302	✓	22	I512	145TTGR16002	✓	79	K066	56T17D3304	✓	38	K238	5K49SN2184	✓	117
I103	SEE I103A		22	I513	145TTGR16004	✓	79	K067	56T17D3305		36	K239	SEE P107		54,117
I103A	182TCDW7001	✓	22	I514	182TTGR16040	✓	79	K068	56T17D3306	✓	37	K240	5K49ZN2190	✓	117
I104	SEE I104A		22	I515	145TTGR16039	✓	79	K069	56T17D3307	✓	37	K247	5K49DN4132	✓	40
I104A	184TBDW17008	✓	22	I700	145TBFR5334	✓	30	K080	56T17D3308	✓	38	K248	5K49FN4138	✓	40
I105	213TCDW7001	✓	22,168	I702	145TBFR5336		175	K081	56T17D15528		37	K249	5K42HN4127	✓	40
I106	215TCDW17002	✓	22	I707	143TBFR5376		29	K111	SEE G044		36	K250	5K46KN4125	✓	40
I108A	184TBDW7001	✓	22,168	J009	SEE C330		115,157	K113	5K35FN2	✓	36	K251	5K46MN4126	✓	40
I110	SEE C188		21	J013	SEE C332		115,157	K114	SEE G047		36	K252	5K49DN4130	✓	53
I111	SEE C191		22	J017	SEE C334		115,157	K115	5K36JN2	✓	36	K253	5K33JNA943	✓	53
I112A	182TCDW7026	✓	22	J019	SEE C336		115,157	K116	5K42HN4106	✓	36	K254	5K35MNB114	✓	53
I113	SEE I113A		22	J021	SEE C338		115,157	K117	SEE G067		36	K255	5K36PNB116	✓	53
I113A	184TCDW7026	✓	22	J023	SEE C340		115,157	K118	SEE G080		36	K256	5K49MN4104	✓	53
I114	SEE I114A		22,168	J025	SEE J1025		115,157	K119	5K46KN4071	✓	36	K257	5K49SN4117	✓	53
I114A	184TBDW7026	✓	22,168	J033	SEE C329		115	K120	SEE G088		36	K258	5K49KN4124	✓	55



Index

Catalog Number/Model Number

CAT. NO.	MODEL NO.	STOCK	PAGE NO.	CAT. NO.	MODEL NO.	STOCK	PAGE NO.	CAT. NO.	MODEL NO.	STOCK	PAGE NO.	MODEL NO.	CAT. NO.	STOCK	PAGE NO.
K259	5K49MN4110	✓	55	K609	5K49TN4622X	✓	68	K1411	5K38PN258X	✓	154	K2051	5KE49UN8405	✓	108
K260	5K49SN4119	✓	56	K610	5K49RN4621X	✓	68	K1412	5K46MN4087X	✓	154	K2052	SEE N321A		108
K275	5K33GN45	✓	154	K612	56B34F5306	✓	175	K1413	5K49KN2150X	✓	154	K2053	5KE48WN8366	✓	108
K277	5K46KN4085	✓	154	K615	56B34F5312	✓	175	K1415	5K49PN4088X	✓	154	K2055	5KE49TN8378	✓	109
K278	5K46MN4087	✓	154	K618	56B34F5318	✓	175	K1416	5K49NN2147X	✓	154	K2056	5KE48WN8364	✓	109
K279	5K49PN3053	✓	154	K622	SEE K622A		40	K1418	5K49UN4086X	✓	154	K2058	5KE49TN8390	✓	110
K280	5K49PN3052	✓	154	K622A	145TTDR14049	✓	40	K1438	5K49NN4052T	✓	106	K2059	5KE49TN8398	✓	110
K281	5K32GN48	✓	153	K631	56B34F5324		32	K1476	5K49JN4051T	✓	106	K2060	5KE49TN8389	✓	110
K282	5K35MN294	✓	153	K633	5K36MN4152	✓	53	K1482	5K48WN3013S	✓	146,158	K2061	SEE N612A		110
K283	5K33KN52	✓	153	K634	SEE K634A		40	K1483	5K37MN3543	✓	116	K2062	5KE48WN8388	✓	110
K284	5K42HN4128	✓	153	K634A	143TTDR14049	✓	40	K1484	5K46KN2082	✓	116	K2063	5KE49WN8383	✓	110
K285	5K49MN6080	✓	153	K635	5K46MN4623	✓	41	K1485	5K49RN6118S	✓	145	K2064	SEE G347		47
K286	5K49KN4142	✓	153	K637	SEE P106		53,117	K1486	5K48TN6119S	✓	145,158	K2065	5KE48WN4586	✓	110
K318	5K42JN4163	✓	36	K640	5K49QN4609	✓	54	K1487	5K49MN6126T	✓	159	K2066	5KE48WN4593	✓	109
K319	56B17F5319	✓	32,101,175	K642	SEE P105		53,117	K1490	5K49PN6164	✓	53	K2067	5KE49TN4597	✓	110
K319-(GE)	SEE KG319		176	K644	5K49ZN4611	✓	40	K1491	5K49ZN4253	✓	53	K2068	5KE49TN4592	✓	109
K321	5K35MN75	✓	47	K646	5K49RN4617	✓	41	K1492	5K49ZN4252	✓	48	K2069	5KE49PN4594	✓	36
K330	SEE K2033		53	K648	5K49ZN4616	✓	41	K1494	5K49RN4570	✓	99	K2084	SEE K2033		53
K332	56B34F5303		175	K690	5K46HN2546	✓	41	K1497	5K49WN4335X	✓	154	K2085	SEE Y366		87
K339	56C34F5327		29	K700	56T11F5328	✓	56	K1500	5K49MN6432S	✓	146	K2087	SEE Y368		87
K350	56B34F5322		30	K701	56T11F5307	✓	55	K1505	5K46LN6428S	✓	146	K2088	SEE GT1209		66
K378	5K46LN6033S	✓	146	K702	56T34T5309	✓	55	K1510	5K49RN6429S	✓	146	K2090	SEE K1491		53
K379	5K49RN6034S	✓	146	K703	56T17F5316	✓	55	K1511	5K48WN3181S	✓	146,158	K2101	5K49FN6381X	✓	79
K381	5K42HN4089	✓	154	K704	56T34F5348	✓	55	K1515	5K48TN6430S	✓	146	K2102	5K49JN4582X	✓	79
K392	SEE G086		36	K705	56T17F5336	✓	55	K1520	5K49ZN6433S	✓	146	K2103	5K49JN4560X	✓	79
K393	SEE K007		37	K706	56T34F5349	✓	55	K2001	SEE E783		37	K2104	5K49HN6385X	✓	79
K402	SEE H181		36	K707	56T17F5337	✓	55	K2002	SEE U246		42	K2105	5K49JN4574X	✓	79
K404	56T11F5320		53	K708	56T34F5350	✓	55	K2003	SEE E784		37	K2106	SEE G661		79
K405	56T17F2047		53	K709	56T17F5338	✓	55	K2004	SEE U1248		42	K2107	5K49MN8349X	✓	79
K406	SEE K640		54	K717	5K32GNB249X	✓	79	K2005	SEE E715		36	K2108	5K49HN2507X	✓	79
K407	56T11F5321		53	K718	SEE G647		79	K2006	SEE U759		42	K2109	SEE G663		79
K408	5K49SN8050	✓	37	K721	56T34F5351	✓	56	K2007	SEE U760		42	K2110	5K49TN6383X	✓	79
K418	5K32GN53	✓	47	K722	56T17F5339	✓	56	K2010	5KE49UN8416	✓	37	K2111	5K49NN4580X	✓	79
K420	SEE K151		47	K723	56T34F5352	✓	56	K2011	SEE E2109		59	K2112	5K49JN4576X	✓	80
K421-(GE)	SEE G1340		47	K724	56T17F5340	✓	56	K2012	SEE E2101		58	K2113	5K49JN4577X	✓	80
K424	5K49MN4111	✓	47	K725	56T34F5353	✓	56	K2013	SEE E2126		58	K2114	5K49LN4578X	✓	80
K426	5K42HN4134	✓	47	K748	5K35FN101	✓	116	K2014	SEE E951		48	K2115	5K49NN4581X	✓	80
K439	5K49DN4131	✓	47	K750	5K46MN4144	✓	116	K2015	SEE E838		48	K2116	5K49MN6382X	✓	79
K456	5K49KN4573	✓	99	K751	5K49PN4121	✓	116	K2016	SEE E2107		59	K2201	SEE I502		79
K457	5K49KN4563	✓	99	K803	SEE K500		55	K2017	SEE E847		48	K2202	5KE49TN8356V	✓	79
K458	5K49PN4564	✓	99	K806	56T17F5330		56	K2018	5KE49PN8418	✓	40	K2203	SEE I506		79
K459	5K49UN4569	✓	99	K1221	SEE K700		56	K2019	SEE C102		40	K2205	5KE49SN8355V	✓	79
K460	5K49PN4565	✓	99	K1222	SEE K701		55	K2020	SEE C103		40	K2206	SEE I514		79
K461	5K49UN4566	✓	99	K1299	5K46MN6018	✓	40	K2021	5KE49PN8391	✓	41	KG215	5K35FN55	✓	40,116,157
K462	5K49UN4567	✓	99	K1300	5K49PN6019	✓	40	K2022	5KE49TN8401	✓	41	KG219	5K37MN38	✓	116
K469	5K42HN4137	✓	53	K1305	5K42FN4033	✓	41	K2023	5KE49UN8407	✓	41	KG232	5K36MN339	✓	117
K499	SEE D392		55	K1306	5K49FN2045	✓	41	K2024	SEE C150A		40	KG234	5K38RN49	✓	117
K500	5K38RN106	✓	55	K1307	5K42HN4032	✓	41	K2025	SEE C201		53	KG235	5K49PN2348	✓	53
K501	SEE D395		56	K1308	5K46KN4031	✓	41	K2026	SEE U733		66	KG236	5K49PN2330	✓	117
K518	5K49SN3054	✓	154	K1311	5K49NN2046	✓	41	K2027	SEE C202A		53	KG237	5K49SN2187	✓	53
K519	5K49SN3055	✓	154	K1314	SEE G586		55	K2028	SEE GT1206		66	KG319	5K49UN8052	✓	176
K520	5K48UN3056	✓	154	K1315	SEE G587		55	K2029	SEE C220A		53	L102	SEE E1904		38
K521	5K49PN4120	✓	40	K1316	5K49MN6020	✓	53	K2030	5KE49TN8384T	✓	154	L409	SEE L409A		50
K522	5K33KN67	✓	53	K1317	5K49PN6025	✓	53	K2031	SEE GT1204		66	L409A	182TTFN4101	✓	50
K523	5K36PN254	✓	53	K1318	5K49PN8030	✓	53	K2032	SEE GT1201		66	L410	SEE L410A		50
K524	5K49MN4112	✓	53	K1322	5K42FN4035	✓	55	K2033	5KE48WN8365	✓	53	L410A	184TTFN14101	✓	50
K525	5K49MN4114	✓	153	K1323	SEE D391		55	K2034	SEE GT1207		66	L410B	184TTFN4102	✓	50
K526	5K49MN6369	✓	99	K1324	5K42HN4034	✓	55	K2035	SEE C250		53	L411	SEE L411A		50
K527	5K35JN198	✓	36	K1325	SEE G588		55	K2036	SEE GT1202		66	L411A	213TTFN4103	✓	50
K541	5K49MN6081	✓	153	K1326	SEE G589		55	K2037	5KE49UN8376T	✓	154	L412	SEE L412A		50
K544	5K42JN3051	✓	154	K1328	SEE D394		56	K2038	5KE49QN8375T	✓	154	L412A	254TTFNA14103	✓	50
K546	5K42JN3050	✓	154	K1402	5K39SNB505S	✓	146	K2039	5KE49UN8429	✓	55	L413	SEE L413A		50
K549	5K48UN3057	✓	154	K1403	5K36PN345S	✓	146	K2040	5KE49UN8370T	✓	154	L413A	256TTFNA14101	✓	50
K550	5K42HN4133	✓	117	K1404	5K38SN267S	✓	146	K2042	SEE C236A		54	L414	SEE L414A		51
K553	5K42HN4139	✓	116	K1405	5K39SNB765T	✓	146	K2043	5KE49UN8428	✓	40	L414A	284TTFNA14102	✓	51
K555	5K46KN4141	✓	116	K1407	5K39SNB587S	✓	146	K2045	5KE49WN4571	✓	99	L415	SEE L415A		51
K606	5K42GN4619X	✓	68	K1408	5K42HN4089X	✓	154	K2046	5KE49WN4572	✓	99	L415A	286TTFNA14106	✓	51
K607	5K49MN4620X	✓	68	K1409	5K37MN252X	✓	154	K2048	SEE C221A		53	L416	SEE L416A		51
K608	5K49MN4618X	✓	68	K1410	5K46KN4085X	✓	154	K2049	SEE E994		48	L416A	324TTFN14101	✓	51

Catalog Number/Model Number

CAT. NO.	MODEL NO.	STOCK	PAGE NO.	CAT. NO.	MODEL NO.	STOCK	PAGE NO.	CAT. NO.	MODEL NO.	STOCK	PAGE NO.	CAT. NO.	MODEL NO.	STOCK	PAGE NO.
L417	326TFPA8107	✓	51	M168	215TTDW7025		129	M420	SEE U348		126	M840	405TTDS7124		137
L417A	326TTFSS14101	✓	51	M170	182TTDR5338	✓	128	M421	SEE U348		126	M841	SEE M841A		137
L420	364TTFSS8101	✓	51	M171	SEE U162A		128	M422	SEE U319A		125	M841A	364TTDS14011		137
L421	SEE L421A		50	M172	SEE U165A		128	M423	SEE U322A		125	M842	SEE M842A		137
L421A	215TTFSS14103	✓	50	M213	254TTFLL5003	✓	130	M801	SEE M801A		136	M842A	365TTDS4328		137
L425	365TTFSS8115	✓	51	M216	184TTFR8914	✓	130	M801A	182TTDR14027		136	M843	SEE M843A		137
L426	404TTFSS8102	✓	51	M217	SEE U366		130	M802	SEE M802A		136	M843A	405TTDS4376		137
L427	405TTFSS8114	✓	51	M301	143TTDR5336	✓	119	M802A	213TTDW14084		136	M844	SEE M844A		137
L428	444TTFSS8106		52	M302	143TTDR5334	✓	119	M803	SEE M803A		136	M844A	444TTDS14101		137
L429	445TTFN8115	✓	52	M303	143TTDR5309	✓	119	M803A	182TTDR14026		136	M845	SEE M845A		137
L440	445TTFN8102		52	M304	SEE E095		119	M804	SEE M804A		136	M845A	365TTDS14009		137
L442	449TTFSS8111		52	M305	SEE E102		119	M804A	184TTDR4173		136	M846	SEE M846A		137
L449	449TTFSS8110	✓	52	M306	145TTDR5346	✓	119	M805	SEE M805A		136	M846A	404TTDS4359		137
L450	SEE L451A		52	M307	145TTDR5313	✓	119	M805A	215TTDW14087		136	M847	SEE M847A		137
L451	SEE L451A		52	M308	145TTDR5314	✓	119	M807	SEE M807A		136	M847A	444TTDS14086		137
L451A	449TSTFS14007	✓	52	M309	SEE E104		119	M807A	213TTDW14054		136	M848	445TTDS7121		137
L452	445TTFN8040	✓	52	M310	145TTDR5350	✓	119	M808	SEE M808A		136	M849	SEE M849A		137
L453	445TTFN9041		52	M311	145TTDR5315	✓	120	M808A	254TDX14088		136	M849A	404TTDS14005		137
L454	449TTFSS8038	✓	52	M312	145TTDR5316	✓	120	M810	SEE M810A		136	M850	SEE M850A		137
L455	449TTFSS8028		52	M313	182TTDB7355	✓	120	M810A	215TTDW4071		136	M850A	405TTDS14067		137
L456	449TTFSS8087	✓	52	M314	SEE E098		120	M811	SEE M811A		136	M851	SEE M851A		137
L457	449TTFSS8077		52	M315	SEE M1315		120	M811A	256TTDX4094		136	M851A	445TTDS14087		137
L459	449TSTFS8002	✓	52	M316	182TTDR7601	✓	120	M813	SEE M813A		136	M852	505UTDS805		137
L460	SEE L462		52	M317	184TTDB7357	✓	120	M813A	215TTDW14018		136	M853	SEE M853A		137
L461	SEE L472A		52	M318	SEE E158A		120	M814	SEE M814A		136	M853A	405TTDS14003		137
L462	449TTFSS8037	✓	52	M319	SEE E109A		120	M814A	254TDX14064		136	M854	SEE M854A		137
L463	449TTFSS8027	✓	52	M320	SEE E163A		120	M815	SEE M815A		136	M854A	444TTDS14057		137
L464	449TTFSS8086	✓	52	M321	213TTDBA7047	✓	121	M815A	284TTDR14082		136	M855	SEE M855A		137
L465	449TTFSS8076		52	M322	SEE E168		121	M818	SEE M818A		136	M855A	445TTDS17084		137
L466	449TSTFS8001	✓	52	M323	213TTDW7022	✓	121	M818A	256TTDX14039		136	M856	505UTDS819		137
L467	449TTFSS8036	✓	52	M324	213TTDW7023	✓	121	M819	SEE M819A		136	M857	SEE M857A		137
L469	SEE L469A		52	M325	215TTDBA7047	✓	121	M819A	286TTDR14081		136	M857A	444TTDS14003		137
L469A	449TTFSS14043	✓	52	M326	215TTDW7048	✓	121	M820	SEE M820A		136	M858	SEE M858A		137
L471	449TTFSS18105		52	M327	215TTDW7022	✓	121	M820A	324TTDR14104		136	M858A	445TTDS14063		137
L472	SEE L472A		52	M328	215TTDW7023	✓	121	M821	SEE M821A		136	M859	SEE M859A		137
L472A	---		52	M329	SEE E114A		121	M821A	256TTDX4310		136	M859A	505UTDS14077		137
L633	SEE U605A		48	M330	254TDX7008	✓	121	M822	SEE M822A		136	M860	505UTDS5820		137
M101	SEE U123A		127	M331	256TTDX7074	✓	122	M822A	286TTDR14046		136	M861	SEE M861A		137
M102	SEE U126		127	M332	256TTDX7011	✓	122	M823	SEE M823A		136	M861A	445TTDS14003		137
M103	SEE U129A		127	M333	284TDP7338	✓	122	M823A	324TTDR14080		136	M862	SEE M862A		137
M105	145TTDR5354	✓	127	M334	SEE U109A		122	M824	SEE M824A		136	M862A	445TTDS14062		137
M109	145TTDR5356	✓	127	M335	SEE U114		122	M824A	326TTDR14103		136	M863	SEE M863A		137
M110	SEE U150A		127	M351	SEE U112		122	M825	SEE M825A		136	M863A	505UTDS3999		137
M111	145TTDR5319	✓	128	M352	SEE U116		122	M825A	284TTDR14011		136	M864	---		137
M113	SEE U159A		128	M353	254TDX7046	✓	121	M826	SEE M826A		136	M866	SEE M866A		137
M114	SEE U165A		128	M358	324TDP7320	✓	122	M826A	286TTDR14042		136	M866A	---		137
M115	SEE M115A		128	M360	SEE E106A		120	M828	SEE M828A		136	M867	SEE M867A		137
M115A	184TTDW7358	✓	128	M361	SEE E148A		120	M828A	364TTDS14104		136	M867A	---		137
M116	184TTDR7604	✓	128	M362	SEE E107A		120	M829	286TTDR17009		136	M868	---		137
M117	213TTDW7049	✓	128	M363	SEE E153A		120	M830	SEE M830A		136	M869	SEE M869A		137
M118	213TTDW7024	✓	129	M401	SEE U301		125	M830A	324TTDR14049		136	M869A	---		137
M119	215TTDW7049	✓	129	M402	SEE U307		125	M831	SEE M831A		136	M870	---		137
M120	SEE U201A		129	M403	SEE U310A		125	M831A	364TTDS14081		136	M871	SEE M871A		137
M121	254TTDX7042	✓	129	M404	SEE U313A		125	M832	SEE M832A		136	M871A	---		137
M122	254TTDX7043	✓	129	M405	SEE U316A		125	M832A	365TTDS14101		136	M873	---		137
M123	SEE U213		129	M406	SEE U319A		125	M833	SEE M833A		136	M874	---		137
M124	SEE U219		129	M407	SEE U322A		125	M833A	324TTDR14010		136	M875	SEE M875A		138
M125	SEE U225		129	M408	SEE U325A		125	M834	SEE M834A		136	M875A	182TFW14005		138
M126	284TDP7072	✓	130	M409	SEE U329		125	M834A	326TTDR14034		136	M876	SEE M876A		138
M127	284TDP7302	✓	130	M410	SEE U334		125	M835	SEE M835A		136	M876A	182TFW14026		138
M128	286TDP7054	✓	130	M411	SEE U337		126	M835A	365TTDS14082		136	M877	SEE M877A		138
M129	286TDP7018	✓	130	M412	SEE U340		126	M836	SEE M836A		136	M877A	213TFW14080		138
M130	324TDP7073	✓	130	M413	SEE U344		126	M836A	404TTDS14102		136	M879	SEE M879A		138
M131	326TDP7330	✓	130	M414	SEE U351		126	M837	SEE M837A		137	M879A	184TFW14026		138
M133	SEE U240		130	M415	SEE U304A		125	M837A	326TTDR14010		137	M880	SEE M880A		138
M163	184TTDR8039		128	M416	SEE U360		125	M838	SEE M838A		137	M880A	215TFW14083		138
M165	SEE U186A		128	M416A	SEE U360		125	M838A	364TTDR14032		137	M881	SEE M881A		138
M166	SEE U192		129	M417	SEE U357		126	M839	SEE M839A		137	M881A	213TFW14010		138
M167	215TTDW7050		129	M418	SEE U363		125	M839A	404TTDS14081		137	M883	SEE M883A		138



Index

Catalog Number/Model Number

CAT. NO.	MODEL NO.	STOCK	PAGE NO.	CAT. NO.	MODEL NO.	STOCK	PAGE NO.	CAT. NO.	MODEL NO.	STOCK	PAGE NO.	MODEL NO.	CAT. NO.	STOCK	PAGE NO.
M883A	254TTFNA14084		138	M1114	SEE U165A		128	N438	145TTWD5528	✓	111	N623	56T17W5339		110
M884	SEE M884A		138	M1116	SEE U177A		128	N438A	145TTWD4528	✓	111	N626	SEE N626A		110
M884A	215TTFW14021		138	M1216	SEE U372		130	N450	56T34VD5301	✓	111	N626A	143TTWR6028	✓	110
M885	SEE M885A		138	M1314	SEE E098		120	N451	56T34VD5302	✓	111	N627	56T17W5341	✓	110
M885A	215TTFW14040		138	M1315	182TTDB7325	✓	120	N452	56T34VD5303	✓	111	N628	56T17W5334	✓	110
M886	SEE M886A		138	M1316	182TTDB7601	✓	120	N453	56T34WD5301		111	N629	145TTVR5030	✓	110
M886A	256TTFNA14084		138	M1317	184TTDW7357	✓	120	N454	SEE N454A		111	N630	145TTWR6033	✓	110
M888	254TTFNA7012		138	M1319	SEE E109A		120	N454A	143TTWD6001	✓	111	N640	56T17V5326	✓	109
M890	SEE M890A		138	M1320	SEE E163A		120	N455	56T34WD5302	✓	111	N641	56T17V5327	✓	109
M890A	284TTFFPA14049		138	M1322	213TTDBA7048	✓	121	N456	143TTWD4002	✓	111	N642	56T17V5328	✓	109
M892	SEE M892A		138	M1323	213TTDBA7022	✓	121	N456A	143TTWD6002	✓	111	N643	56T34V5301	✓	109
M892A	256TTFNA14016		138	M1327	SEE E113		121	N457	56T34WD5303	✓	111	N644	56T17V5329	✓	109
M893	256TTFNA7028		138	M1407	SEE U322A		125	N458	SEE N458A		111	N645	56T34V5302	✓	109
M894	SEE M894A		138	M1408	SEE U325A		125	N458A	145TTWD6001	✓	111	N646	56T17V5330	✓	109
M894A	286TTFNA14085		138	N309	56T17V5346	✓	108	N523	56C17W5327	✓	107	N647	143TTVR5326	✓	109
M896	284TTFNA7508		138	N310	143TTVR5329	✓	108	N524	56C34W5303		107	N648	56T34V5303		109
M897	SEE M897A		138	N312	SEE N312A		108	N525	56C17W5328	✓	107	N649	56T17V5331	✓	109
M897A	284TTFFPA14048		138	N312A	145TTWR6027	✓	108	N526	56C34W5304		107	N650	143TTVR5327	✓	109
M898	SEE M898A		138	N313	56T17W5328		108	N527	56C17W5329	✓	107	N651	56T34V5304	✓	109
M898A	324TTFFPA14089		138	N314B	182TTWW6027	✓	108	N528	56C34W5305		107	N652	145TTVR5301		109
M899	SEE M899A		138	N315	SEE N315A		108	N529	56C17W5330	✓	107	N653	56T17W5326	✓	109
M899A	326TTFS14103		138	N315A	184TTWW6004		108	N531	56C17W5326	✓	107	N654	SEE N654A		109
M900	SEE M900A		138	N316	SEE N316B		108	N532	56C34W5302	✓	107	N654A	145TTWR4326	✓	109
M900A	286TTFFPA14011		138	N316B	184TTWW6027	✓	108	N540	56C34W5308	✓	107	N655	145TTWR5301	✓	109
M901	SEE M901A		138	N317	SEE N317A		108	N541	56C17W5333	✓	107	N655A	145TTWR4301	✓	109
M901A	286TTFFPA14063		138	N317A	184TTWW6003		108	N542	56C34W5309	✓	107	N656	SEE N656B		109
M902	SEE M902A		138	N318	213TTWR4027	✓	108	N543	56C17W5334	✓	107	N656B	182TTWW4028	✓	109
M902A	326TTFS14087		138	N318A	213TTWR6027	✓	108	N544	56C34W5310	✓	107	N657	SEE N657B		109
M904	SEE M904A		138	N319	SEE N319A		108	N545	56C17W5335		107	N657B	184TTWW4002	✓	109
M904A	324TTFS14003		138	N319A	215TTWR6027	✓	108	N557	56C17W5331	✓	107	N658	SEE N658B		109
M905	SEE M905A		138	N320	56T17W5340	✓	108	N558	56C34W5307	✓	107	N658B	184TTWW4028	✓	109
M905A	324TTFFPA14065		138	N321	145TTWR4029	✓	108	N559	56C17W5332	✓	107	N659	SEE N659A		109
M906	SEE M906A		138	N321A	145TTWR6029	✓	108	N564	56T17V5332	✓	110	N659A	213TTWR4001	✓	109
M906A	364TTFS14087		138	N322	56T17W5344		108	N566	56T34V5305	✓	110	N660	213TTWR7026		109
M907	365TTFS17102		138	N323	145TTWR6076	✓	108	N567	56T17V5336	✓	110	N661	215TTWR7026		109
M909	SEE M909A		138	N400	56T17V5347		112	N568	56T11V5376	✓	110	N1314	SEE N314B		108
M909A	326TTFFPA14049		138	N401	56T17V5348	✓	112	N569	56T34V5306	✓	110	N1315	SEE N315A		108
M910	SEE M910A		138	N402	56T17V5349	✓	112	N599	56T17V5338	✓	110	N1316	SEE N316B		108
M910A	365TTFS14084		138	N403	143TTVD5326		112	N600	56T11V5377		110	N1317	SEE N317A		108
M912	SEE M912A		139	N404	SEE N404A		112	N601	56T34V5307	✓	110	N1614	182TTWW4026	✓	110
M912A	364TTFS14003		139	N404A	145TTWD6026		112	N602	56T17V5340	✓	110	N1615	SEE N615B		110
M913	SEE M913A		139	N405	SEE N405A		112	N604	56T11W5377	✓	110	N1616	SEE N616B		110
M913A	364TTFS14058		139	N405A	145TTWD6027	✓	112	N605	56T34V5308	✓	110	N1656	182TTWW7026	✓	109
M914	SEE M914A		139	N406	SEE N406A		112	N606	56T17V5342	✓	110	N1657	SEE N657B		109
M914A	404TTFS14088		139	N406A	182TTWD6031	✓	112	N607	145TTVR5326	✓	110	N1658	SEE N658B		109
M916	SEE M916A		139	N407	SEE N407A		112	N608	56T11W5378	✓	110	O002	48S17S25	✓	156
M916A	365TTFS7923		139	N407A	184TTWD6031	✓	112	N609	56T34V5309	✓	110	O003	48S17S24	✓	156
M917	SEE M917A		139	N408	SEE N408A		112	N610	145TTVR5302	✓	110	O004	48S34S2003	✓	156
M917A	365TTFS14060		139	N408A	213TTWD6031	✓	112	N611	56T17W5327	✓	110	O005	48S34S2004	✓	156
M918	SEE M918A		139	N409	SEE N409A		112	N612	SEE N612A		110	O010	48C34D2024	✓	156
M918A	405TTFS14087		139	N409A	215TTWD6031	✓	112	N612A	145TTWR6026	✓	110	O011	48C34D2028	✓	156
M919	444TTFS7403		139	N410	56T17VD5326	✓	111	N613	SEE N613A		110	O012	48C34S24	✓	156
M920	405TTFS7612		139	N411	56T17VD5328	✓	111	N613A	145TTWR6001	✓	110	O013	48C34S2001		156
M921	SEE M921A		139	N412	56T17VD5327	✓	111	N614	SEE N614B		110	O014	SEE O010		156
M921A	405TTFS14063		139	N413	56T17WD5326	✓	111	N614B	182TTWW6026	✓	110	O100	48S34S361	✓	156
M922	SEE M922A		139	N414	143TTWD4026	✓	111	N615	SEE N615B		110	O102	48S34S2005	✓	156
M922A	444TTFN14080		139	N414A	143TTWD6026	✓	111	N615B	184TTWW6001	✓	110	O200	56S34D2000	✓	157
M924	444TTFS7321		139	N415	56T17WD5329	✓	111	N616	SEE N616B		110	O201	56S34D93	✓	157
M925	SEE M925A		139	N417	56T17WD5328	✓	111	N616B	184TTWW6026	✓	110	O210	56C34D2114	✓	157
M925A	444TTFN14044		139	N418	145TTWD4029	✓	111	N617	SEE N617A		110	O211	56C34D2109	✓	157
M926	SEE M926A		139	N418A	145TTWD6029	✓	111	N617A	213TTWR6002	✓	110	O212	56C34D2098	✓	157
M926A	445TTFN14086		139	N430	56T17VD5329	✓	111	N618	SEE N618A		110	O213	56C34D2099	✓	157
M928	SEE M928A		139	N431	56T17VD5330	✓	111	N618A	213TTWR6026	✓	110	O214	56C34D2104	✓	157
M928A	445TTFN14003		139	N432	56T17VD5331	✓	111	N619	SEE N619A		110	O215	56C34D2112	✓	157
M929	SEE M929A		139	N433	56T17WD5330	✓	111	N619A	215TTWR6026	✓	110	O217	56C34D2105	✓	157
M929A	445TTFN14326		139	N434	143TTWD5527	✓	111	N620	SEE N620A		110	O231	56B34D2028	✓	157
M931	449TTFS7109		139	N434A	143TTWD4527	✓	111	N620A	56T17V15501	✓	110	O232	56B34D5337		157
M933	SEE M933A		139	N435	56T17WD5331	✓	111	N621	56T17W5335		110	O600	48S17T286	✓	156
M933A	445TTFN14330		139	N437	56T17WD5332	✓	111	N622	56T17V5337	✓	110	O601	48S17T290	✓	156

Catalog Number/Model Number

CAT. NO.	MODEL NO.	STOCK	PAGE NO.	CAT. NO.	MODEL NO.	STOCK	PAGE NO.	CAT. NO.	MODEL NO.	STOCK	PAGE NO.	CAT. NO.	MODEL NO.	STOCK	PAGE NO.
O701	48A34SU1001	✓	156	R323A	112MTFC6576	✓	97	R368	80T11FH5409	✓	98	R431	SEE R431A		97
P001	SEE KG215		40,116,157	R324	SEE R324A		97	R369	71T34FH5410	✓	98	R431A	132MTFC6537	✓	97
P002	SEE K216		40,116,157	R324A	112MTFC6511	✓	97	R370	80T17FH5411	✓	98	R451	SEE R451A		97
P003	SEE K218		40,116,157	R325	SEE R325A		97	R371	80T11FH5412	✓	98	R451A	100LTF6502	✓	97
P004	SEE K220		40,116,157	R325A	112MTFC6536	✓	97	R372	80T34FH5413	✓	98	R452	SEE R452A		97
P005	SEE K222		40,116,157	R326	SEE R326A		97	R373	80T17FH5414	✓	98	R452A	100LTF6537	✓	97
P006	SEE K224		40,116,157	R326A	132MTFC6586	✓	97	R374	SEE R374A		98	R500	225MTFC6501	✓	97
P007	SEE K226		40,116,157	R327	SEE R327A		97	R374A	90ST11FH6415	✓	98	R501	225MTFC6526	✓	97
P101	56T34T5306	✓	53,117	R327A	132STFC6501	✓	97	R375	80T34FH5416	✓	98	R502	280STFC6586	✓	97
P102	56T34F5321	✓	53,117	R328	SEE R328A		97	R376	SEE R376A		98	R503	250MTFC6501	✓	97
P103	56T34F5322	✓	53,117	R328A	132STFC6526	✓	97	R376A	90ST17FH6417	✓	98	R504	250MTFC6526	✓	97
P104	56T34F5323	✓	53,117	R329	SEE R329A		97	R377	SEE R377A		98	R505	280MTFC6588	✓	97
P105	56T34F5324	✓	53,117	R329A	132MTFC6587	✓	97	R377A	90ST34FH6418	✓	98	R506	280STFC6501	✓	97
P106	56T34F5325	✓	53,117	R330	SEE R330A		97	R378	SEE R378A		98	R507	280STFC6526	✓	97
P107	56T34F5326	✓	54,117	R330A	132STFC6502	✓	97	R378A	90L17FH6419	✓	98	R508	315STFC6588	✓	97
P180	5KCP49WN9813S	✓	144	R331	SEE R331A		97	R379	SEE R379A		98	S003	48S17D2089	✓	23
P184	5KCP49UN9612S	✓	144	R331A	132MTFC6536	✓	97	R379A	90L34FH6420	✓	98	S006	48S17D2090	✓	23
P185	5KCP49UN9614S	✓	144	R332	SEE R332A		97	R380	63T34FH5501	✓	98	S010	48C17D2023	✓	23
P190	5KCP49ZN9617T	✓	142	R332A	160MTFC6586	✓	97	R381	63T17FH5502	✓	98	S011	48C17D2024	✓	23
P193	5KCP39SNB480S	✓	144	R333	SEE R333A		97	R382	71T11FH5503	✓	98	S012	56C17D2098	✓	23
P194	5KCP39SNB481S	✓	144	R333A	160MTFC6511	✓	97	R383	63T34FH5504	✓	98	S013	56C17D2051	✓	23
P195	5KCP39SNB482S	✓	144	R334	SEE R334A		97	R384	71T17FH5505	✓	98	S014	56C17D2054	✓	23
P196	5KCP39TNB763T	✓	144	R334A	160MTFC6536	✓	97	R385	80T11FH5506	✓	98	S015	56C17D2055	✓	23
P197	5KCP39UNB767T	✓	144	R335	SEE R335A		97	R386	71T34FH5507	✓	98	S022	56S17D2046	✓	23
P198	5KCP39UNB764T	✓	144	R335A	160LTF6588	✓	97	R387	71T17FH5508	✓	98	S026	48S17D2113		23
P239	5KCP33GNA471S	✓	106	R336	SEE R336A		97	R388	80T11FH5509	✓	98	S027	56S17D2066	✓	23
P240-(GE)	SEE PG240		159	R336A	160MTFC6512	✓	97	R389	71T34FH5510	✓	98	S030	48C17D2027	✓	23
P241	5KCP36RNA491S	✓	159	R337	SEE R337A		97	R390	80T17FH5511	✓	98	S033	56C17D2064	✓	23
P245	5KCP49PN9812S	✓	144	R337A	160LTF6538	✓	97	R391	80T11FH5512	✓	98	S036	56C17D2067	✓	23
P246	5KCP49UN9811S	✓	144	R338	SEE R338A		97	R392	80T34FH5513	✓	98	S037	56C17D5319	✓	23
P247	5KCP35NNA670T	✓	171	R338A	180LTF6588	✓	97	R393	80T17FH5514	✓	98	S038	56C17D5343	✓	23
P250	5KCP35KNB057S	✓	104	R339	SEE R339A		97	R394	SEE R394A		98	S039	56C17D5320	✓	23
P251	5KCP36NNB059S	✓	104	R339A	160LTF6513	✓	97	R394A	90ST11FH6515	✓	98	S102	48S17D2042	✓	25
P252-(GE)	SEE PG252		171	R340	SEE R340A		97	R395	80T34FH5516	✓	98	S103	48S17D2091		25
P253	5KCP36NNB671U	✓	171	R340A	180MTFC6536	✓	97	R396	SEE R396A		98	S106	48S17D2093	✓	26
P254	5KCP35KNB650U	✓	171	R341	SEE R341A		97	R396A	90ST17FH6517	✓	98	S110	48C17D2028	✓	26
PG240	5KCP35CNA490S	✓	159	R341A	200LTF6588	✓	97	R397	SEE R397A		98	S111	48C17D2029	✓	26
PG252	5KCP36NNB670U	✓	171	R342	SEE R342A		97	R397A	90ST34FH6518	✓	98	S112	56C17D2097	✓	26
R300	63T34FH5301	✓	96	R342A	180MTFC6511	✓	97	R398	SEE R398A		98	S113	56C17D2099	✓	26
R301	63T17FH5326	✓	96	R343	SEE R343A		97	R398A	90L17FH6519	✓	98	S114	56C17D2060	✓	26
R302	71T11FH5376	✓	96	R343A	180LTF6538	✓	97	R399	SEE R399A		98	S115	56C17D2061	✓	26
R303	63T34FH5302	✓	96	R344	SEE R344A		97	R399A	90L34FH6520	✓	98	S116	56C17D5339	✓	26
R304	71T17FH5326	✓	96	R344A	200LTF6589	✓	97	R400	63T34FH5303	✓	96	S117	56C17D5340	✓	26
R305	80T11FH5376	✓	96	R345	SEE R345A		97	R401	63T17FH5327	✓	96	S118	48C17D2045	✓	25
R306	71T34FH5301	✓	96	R345A	200LTF6511	✓	97	R403	63T34FH5304	✓	96	S119	48C17D2046	✓	25
R307	71T17FH5327	✓	96	R346	SEE R346A		97	R404	71T17FH5330	✓	96	S120	56S17D2023	✓	26
R308	80T11FH5377	✓	96	R346A	200LTF6538	✓	97	R407	71T17FH5331	✓	96	S126	48S17D2104	✓	25
R309	71T34FH5302	✓	96	R347	SEE R347A		97	R409	71T34FH5304	✓	96	S127	48S17D2105	✓	26
R310	80T17FH5326	✓	96	R347A	225MTFC6586	✓	97	R410	80T17FH5330	✓	96	S128	48S17D2106	✓	26
R311	80T11FH5378	✓	96	R348	SEE R348A		97	R412	80T34FH5305	✓	96	S501	145TTTTN18577		172
R312	80T34FH5301	✓	96	R348A	200LTF6513	✓	97	R413	80T17FH5331	✓	96	S503	145TTTTN18531		172
R313	80T17FH5327	✓	96	R349	SEE R349A		97	R415	80T34FH5303	✓	96	S504	184TTTS18577		172
R314	SEE R314A		96	R349A	225STFC6526	✓	97	R416	SEE R416A		96	S506	182TTTS18532		172
R314A	90ST11FH6376	✓	96	R350	SEE R350A		97	R416A	90ST17FH6327	✓	96	S507	213TTTS17077		172
R315	80T34FH5302	✓	96	R350A	250MTFC6586	✓	97	R418	SEE R418A		96	S510	215TTTS17077	✓	172
R316	SEE R316A		96	R351	SEE R351A		97	R418A	90ST34FH6302	✓	96	S513	254TTTNA17077	✓	172
R316A	90ST17FH6326	✓	96	R351A	100LTF6501	✓	97	R419	090L17FH5327	✓	96	S516	256TTTNA18578	✓	172
R317	100LTF6586	✓	96	R352	SEE R352A		97	R419A	90L17FH6327	✓	96	S517	284TTTNA18601		172
R318	SEE R318A		96	R352A	100LTF6536	✓	97	R421	SEE R421A		97	S518	254TTTNA18530		172
R318A	90ST34FH6301	✓	96	R353	SEE R353A		97	R421A	90L34FH6302	✓	97	S519	284TTTNA16577		172
R319	SEE R319A		96	R353A	132STFC6586	✓	97	R422A	100LTF6527	✓	97	S522	286TTTNA18577		172
R319A	90L17FH6326	✓	96	R360	63T34FH5401	✓	98	R424	SEE R424A		97	S523	324TTTS18601		172
R320	SEE R320A		96	R361	63T17FH5402	✓	98	R424A	112MTFC6512	✓	97	S525	324TTTS18577		172
R320A	100LTF6576	✓	96	R362	71T11FH5403	✓	98	R425	SEE R425A		97	S528	326TTTS18577		172
R321	SEE R321A		97	R363	63T34FH5404	✓	98	R425A	112MTFC6537	✓	97	S553	145TTTN18532		172
R321A	90L34FH6301	✓	97	R364	71T17FH5405	✓	98	R427A	132STFC6503	✓	97	S554	184TTTS18578		172
R322	SEE R322A		97	R365	80T11FH5406	✓	98	R428	SEE R428A		97	S557	213TTTS17078		172
R322A	100LTF6526	✓	97	R366	71T34FH5407	✓	98	R428A	132STFC6527	✓	97	S560	215TTTS17078	✓	172
R323	SEE R323A		97	R367	71T17FH5408	✓	98	R430A	132STFC6504	✓	97	S564	256TTTNA18601		172



Index

Catalog Number/Model Number

CAT. NO.	MODEL NO.	STOCK	PAGE NO.	CAT. NO.	MODEL NO.	STOCK	PAGE NO.	CAT. NO.	MODEL NO.	STOCK	PAGE NO.	MODEL NO.	CAT. NO.	STOCK	PAGE NO.
S566	256TTTNA18577		172	U037	445TTGN4030		81	U090	SEE U090A		84	U154	145TTDR4123		128
S567	284TTTNA17101	✓	172	U037A	445TTGN16544		84	U090A	445TTGN16588		84	U155	145TTDR4118		128
S569	284TTTNA18577		172	U038	445TTGN4045		81	U091	SEE U091A		84	U156	145TTDR4112		128
T010	56C17F5351	✓	176	U038A	445TTGN16543		84	U091A	449TTGS16585		84	U157	145TTDR4124		128
T013	56C34F5340	✓	176	U039	SEE U039A		82	U092	SEE E571		83	U158	182TTDR4142		128
T014	56C17F5350	✓	176	U039A	145TTGN6576	✓	82	U093	SEE E573A		83	U159	SEE U159A		128
T015	56C34F5339	✓	176	U040	SEE U040A		82	U094	SEE E576A		83	U159A	182TTDW4338	✓	128
T016	56C17F5349	✓	176	U040A	182TTGN6576	✓	82	U095	SEE E850A		84	U160	182TTDR4148		128
T017	56B34F5332	✓	176	U041	SEE U041A		81	U096	SEE E578		84	U161	182TTDR4143		128
T018	56B17F5328	✓	176	U041A	184TTGN6576	✓	82	U097	405TTGS4046	✓	77	U162	182TTDR4048		128
T019	56B34F5333	✓	176	U042	SEE U042		82	U100	256TTDX4041		122	U162A	182TTDW4339		128
T030	56B17F5329	✓	176	U042A	213TTGN6576	✓	82	U101	256TTDX4047		122	U163	182TTDR4149		128
T031	145TBF5309	✓	176	U043	SEE U043A		82	U102	256TTDX4021		122	U164	182TTDR4118		128
U001	SEE U001A		82	U043A	215TTGN6576	✓	82	U103	256TTDX4006	✓	122	U165	SEE U165A		128
U001A	143TTGN6526	✓	82	U044	SEE E500		83	U104	256TTDX4019		122	U165A	182TTDW14011	✓	128
U002	SEE U002A		82	U045	SEE E501		83	U105	284TTDP4043		122	U166	182TTDR4124		128
U002A	145TTGN6526	✓	82	U046	SEE E504		83	U106	284TTDP4069	✓	122	U167	182TTDR4119		128
U003	SEE U003A		82	U047	SEE E507		83	U107	284TTDP4037		122	U168	182TTDR4113		128
U003A	145TTGN6527	✓	82	U048	SEE U048A		83	U108	284TTDP4025		122	U169	182TTDR4125		128
U004	SEE U004A		82	U048A	324TTGS16577	✓	83	U109A	284TTDP14009	✓	122	U170	184TTDR4142		128
U004A	182TTGN6526	✓	82	U049	SEE E565		83	U110	284TTDP4023	✓	122	U171	SEE U171A		128
U005	SEE U005A		82	U050	SEE E568A		83	U111	286TTDP4067		122	U171A	184TTDW4136		128
U005A	184TTGN6526	✓	82	U055	SEE E583		84	U112	286TTDP4037		122	U172	184TTDR4148		128
U006	SEE U006A		83	U058	SEE U058A		82	U113	286TTDP4047		122	U173	184TTDR4143		128
U006A	213TTGN6526	✓	83	U058A	143TTGN6501	✓	82	U114	286TTDP4015	✓	122	U175	184TTDR4149		128
U007	SEE U007A		83	U059	145TTGN4001	✓	81	U115	286TTDP4021		122	U176	184TTDR4117		128
U007A	215TTGN6526	✓	83	U059A	145TTGN6501	✓	82	U116	324TTDP4345		122	U177	SEE U177A		128
U008	SEE E503		83	U060	SEE U060A		82	U117	324TTDP4349		122	U177A	184TTDW14079	✓	128
U009	SEE E506		83	U060A	182TTGN6501	✓	82	U118	324TTDP4004	✓	122	U178	184TTDR4123		128
U010	SEE E547		83	U061	SEE U061A		82	U119	324TTDP4018		122	U179	184TTDR4118		128
U011	SEE E564		83	U061A	184TTGN6501	✓	82	U120	326TTDP4329		122	U180	184TTDR4112		128
U012	SEE E567		83	U062	SEE U062A		83	U121	326TTDP4326		122	U181	184TTDR4124		128
U013	SEE E570		83	U062A	213TTGN6501	✓	83	U122	143TTDR4042		127	U182	213TTDW4044		128
U018	SEE E585		84	U063	SEE U063A		83	U123	SEE U123A		127	U183	213TTDW4049	✓	128
U019	SEE E588		84	U063A	215TTGN6501	✓	83	U123A	143TTDR14048		127	U184	213TTDW4039		128
U020	143TTGN4030	✓	81	U064	SEE E502		83	U124	143TTDR4048		127	U185	213TTDW4051		128
U020A	143TTGN6530	✓	82	U065	SEE E505		83	U125	143TTDR4043		127	U186	SEE U186A		128
U021	145TTGN4035	✓	81	U066	SEE E546		83	U126	143TTDR4037		127	U186A	213TTDW14059		128
U021A	145TTGN6537	✓	82	U067	SEE E563		83	U127	143TTDR4049		127	U187	213TTDW4052		128
U022	145TTGN4040	✓	81	U068	SEE E566		83	U128	143TTDR4018		127	U188	213TTDW4011		129
U022A	145TTGN6540	✓	82	U069	326TSTGP4001	✓	81	U129	SEE U129A		127	U189	SEE U189A		129
U023	182TTGS4030	✓	81	U070	SEE E572		83	U129A	143TTDR14003	✓	127	U189A	213TTDW14013	✓	129
U023A	182TTGN6530	✓	82	U071	365TSTGS4001	✓	81	U130	143TTDR4023		127	U190	213TTDW4012		129
U024	184TTGS4030	✓	81	U073	SEE U073A		84	U131	143TTDR4019		127	U191	213TTDW4013		129
U024A	184TTGN6530	✓	82	U073A	444TSTGN16502		84	U132	143TTDR4011		127	U192	213TTDW4025		129
U025	213TTGS4030	✓	81	U074	SEE E584		84	U133	143TTDR4025		127	U193	213TTDW4014		129
U025A	213TTGN16537	✓	83	U075	SEE U075A		84	U134	145TTDR4042		127	U194	215TTDW4044		129
U026	215TTGS4030	✓	81	U075A	445TSTGN16506		84	U135	SEE U135A		127	U195	215TTDW4049	✓	129
U026A	215TTGN16532	✓	83	U076	SEE U076A		83	U135A	145TTDR4354	✓	127	U196	215TTDW4051		129
U027	254TTGN4030	✓	81	U076A	284TSTGN16531		83	U136	145TTDR4048		127	U197	215TTDW4053		129
U027A	254TTGN16541	✓	83	U077	SEE U077A		83	U137	145TTDR4043		127	U198	SEE U198A		129
U028	256TTGN4030	✓	81	U077A	286TSTGN16531		83	U138	145TTDR4037		127	U198A	215TTDW14073		129
U028A	256TTGN16540	✓	83	U078	SEE U078A		83	U139	145TTDR4049		127	U199	215TTDW4052		129
U029	284TTGP4030		81	U078A	324TSTGS16531		83	U140	145TTDR4017		127	U200	215TTDW4011		129
U029A	284TTGN16539		83	U079	SEE U079A		83	U141	145TTDR4011		127	U201	SEE U201A		129
U030	286TTGP4030		81	U079A	326TSTGS16532		83	U142	145TTDR4023		127	U201A	215TTDW14020	✓	129
U030A	286TTGN16533		83	U080	SEE U080A		83	U143	145TTDR4018		127	U202	215TTDW4012		129
U031	324TTGP4030		81	U080A	364TSTGS16531		83	U144	145TTDR4012		127	U203	215TTDW4013		129
U031A	324TTGS16535		83	U081	SEE U081A		83	U145	145TTDR4024		127	U204	215TTDW4025		129
U032	326TTGP4030		81	U081A	365TSTGS16532		83	U146	145TTDR4068		127	U205	215TTDW4014		129
U032A	326TTGS16539		83	U082	SEE U082A		84	U147	SEE U147A		127	U206	254TTDX4074		129
U033	364TTGS4040		81	U082A	405TSTGS16531		84	U147A	145TTDR4356	✓	127	U207	254TTDX4075	✓	129
U033A	364TTGS16537		83	U083	SEE U083A		84	U148	145TTDR4074		127	U208	254TTDX4340		129
U034	365TTGS4040		81	U083A	444TSTGN16531		84	U149	145TTDR4069		127	U209	254TTDX4060		129
U034A	365TTGS16542		83	U084	SEE U084A		84	U150	SEE U150A		127	U210	254TTDX4041	✓	129
U035	405TTGS4040		81	U084A	445TSTGN16531		84	U150A	145TTDR4355		127	U211	254TTDX4341		129
U035A	405TTGS16539		84	U085	SEE E582A		84	U151	145TTDR4075		127	U212	254TTDX4014		129
U036	444TTGS4042		81	U088	405TTGS4087	✓	81	U152	145TTDR4117		128	U213	254TTDX4017	✓	129
U036A	444TTGN16533		84	U089	404TTGS4087	✓	81	U153	145TTDR4111	✓	128	U214	254TTDX4008		129

Catalog Number/Model Number

CAT. NO.	MODEL NO.	STOCK	PAGE NO.	CAT. NO.	MODEL NO.	STOCK	PAGE NO.	CAT. NO.	MODEL NO.	STOCK	PAGE NO.	CAT. NO.	MODEL NO.	STOCK	PAGE NO.
U215	254TDX4010		129	U302	143TFR4046		125	U403A	184TTDW16043		41	U452A	404TSDS6327		41
U216	254TDX4012		129	U303	143TFR4015		125	U404	SEE U404B		41	U453	SEE U453A		41
U217	254TDX4016		129	U304	SEE U304A		125	U404B	184TTDW16001	✓	41	U453A	404TSDS16006	✓	41
U218	256TDX4064		129	U304A	143TFR4303	✓	125	U405	213TTDW4045	✓	41	U454A	405TSDS16039		41
U219	256TDX4063	✓	129	U305	143TFR4021		125	U405A	213TTDW16063	✓	41	U455	SEE U455A		41
U220	256TDX4328		129	U306	145TFR4048		125	U416	143TTDR4061		36	U455A	405TSDS16005		41
U221	256TDX4065		129	U307	145TFR4045	✓	125	U417	143TTDR4052	✓	36	U456	SEE U456A		41
U223	256TDX4059		129	U308	145TFR4054		125	U417A	143TTDR6052	✓	37	U456A	444TSDS16034		41
U224	256TDX4022		129	U309	145TFR4017		125	U418	143TTDR4051	✓	37	U500	256TTDX4024		134
U225	256TDX4004	✓	129	U310	SEE U310A		125	U418A	143TTDR6051	✓	37	U501	256TTDX4020		134
U226	256TDX4023		129	U310A	145TFR14011	✓	125	U419	145TTDR4128	✓	37	U502	284TDP4027		134
U227	284TDP4044		130	U311	145TFR4023		125	U420	SEE U420A		37	U503	284TDP4047		134
U228	SEE U228A		130	U312	145TFR4050		125	U420A	145TTDR6126	✓	37	U504	284TSDP4002		134
U228A	284TDP14044	✓	130	U313	SEE U313A		125	U421	SEE U421A		37	U505	284TSDP14007		131
U229	284TDP4045		130	U313A	145TFR14045		125	U421A	145TTDR6127		37	U506	286TDP4041		134
U230	284TDP4011		130	U314	145TFR4128		125	U422	145TTDR4134	✓	37	U507	286TDP14042		134
U231	284TDP4022	✓	130	U315	182TFR4015		125	U423	SEE U423A		37	U508	286TSDP4022	✓	134
U232	284TDP4012		130	U316	SEE U316A		125	U423A	145TTDR6132	✓	37	U509	286TSDP4023	✓	134
U233	286TDP4048		130	U316A	182TFR4302	✓	125	U424	SEE U424A		37	U510	324TDP4038		134
U234	286TDP4074	✓	130	U317	182TFR4021		125	U424A	145TTDR6133	✓	37	U511	324TDP14049		134
U235	286TDP4049		130	U319	SEE U319A		125	U425	SEE U1425		38	U512	324TSDP4010	✓	134
U236	286TDP4020	✓	130	U319A	182TFR4330	✓	125	U425B	182TTDW16048		38	U513	324TSDP4007	✓	134
U237	286TDP4024		130	U320	182TFR4056		125	U426	SEE U426B		38	U514	326TDP4345		134
U238	324TDP4348	✓	130	U322A	184TFR4009	✓	125	U426B	182TTDW16049	✓	38	U515	326TDP4344		134
U239	324TDP4033		130	U323	184TFR4021		125	U427	184TTDR4153	✓	38	U516	326TSDP4024	✓	134
U240	324TDP4002	✓	130	U325	SEE U325A		125	U427A	184TTDW4153	✓	38	U517	326TSDP4022	✓	134
U241	324TDP4011		130	U325A	184TFR4760	✓	125	U428	SEE U428B		38	U518	364TSDS4332	✓	134
U242	326TDP4340	✓	130	U326	SEE U326A		125	U428A	SEE U428B		38	U519	364TSDS4337		134
U243	326TDP4032		130	U326A	184TFR14028		125	U428B	184TTDW16038	✓	38	U520	364TSDS4328		134
U244	56T34D6001	✓	42	U327	213TFR4009		125	U429	213TTDW4070		38	U521	326TSDP14034		134
U245	143TTDR6028	✓	42	U328	213TFR4011		130	U430	SEE U430A		38	U522	364TSDS4025	✓	135
U246	145TTDR6039	✓	42	U329	213TFR4022	✓	125	U430A	213TTDW16060	✓	38	U523	364TSDS4024	✓	134
U247	145TTDR6002	✓	42	U330	SEE U372		130	U432	SEE U432A		41	U524	365TSDS4332	✓	135
U249A	184TTDW6001	✓	43	U331	213TFR4010		125	U432A	213TTDW16010		41	U525	365TSDS4347		135
U250	404TSDS6001	✓	44	U332	213TFR4012		130	U433	215TTDW4335	✓	41	U526	365TSDS4025	✓	135
U251	405TSDS6007	✓	44	U334	213TFR4047	✓	125	U433A	215TTDW16061		41	U527	365TSDS4303	✓	135
U252	444TSDS16003	✓	44	U335	213TFR4038		125	U435	215TTDW4315		41	U528	404TSDS4332	✓	135
U254	254TDC6076	✓	43	U336	215TFR4014		126	U436	254TDX4065	✓	41	U529	404TSDS4333	✓	135
U255	256TDC6076	✓	43	U337	215TFR4022	✓	126	U436A	254TTDN16056	✓	41	U530	404TSDS4017	✓	135
U256	284TDC6076	✓	43	U338	215TFR4015		126	U437	254TDX4315		41	U531	404TSDS14008	✓	135
U257	286TDC6076	✓	43	U339	215TFR4035		126	U438	SEE U438A		41	U532	405TSDS4332	✓	135
U265	145TTDR6076	✓	42	U340	215TFR4047	✓	126	U438A	256TTDN16049		41	U533	405TSDS4333		135
U268	213TDC6076	✓	42	U341	215TFR4036		126	U439	256TTDX4315		41	U534	405TSDS4006	✓	135
U269	215TDC6076	✓	42	U343	254TFL4009		130	U439A	256TTDN16009		41	U535	444TSDS4332	✓	135
U270	404TDC6086	✓	43	U344	254TFL4006	✓	126	U440	SEE U440A		41	U536	444TSDS4010	✓	135
U271	405TSDS16081	✓	44	U345	SEE U345A		130	U440A	286TSDN16034		41	U537	445TSDS4332	✓	135
U272	444TSDS16077	✓	44	U345A	254TFL14008	✓	130	U441	SEE U441A		41	U538	364TSDS14329		134
U273	445TSDS16076	✓	44	U346	254TFL4010		126	U441A	286TSDN16005	✓	41	U539	445TSDS14007	✓	135
U274	447TSDN16077	✓	44	U347	254TFL4034		126	U442	SEE U442A		41	U540	445TSDS14051	✓	135
U275	449TSDN16076	✓	44	U348	254TFL4031	✓	126	U442A	286TSDN16033		41	U601	145TTN4032		50
U279	213TDC6079	✓	42	U349	254TFL4036		126	U443	SEE U443A		41	U602	182TFS4001	✓	50
U280	215TDC6079	✓	42	U350	256TFL4010		126	U443A	286TSDN16004	✓	41	U602A	182TFC6002	✓	59
U281	213TDC6029	✓	43	U351	256TFL4006	✓	126	U444	SEE U444A		41	U603	SEE E2134		59
U282	254TDC6079	✓	43	U352	256TFL4012		126	U444A	324TSDP16032		41	U604	182TFS4005		50
U283	213TDC6003	✓	43	U353	256TFL4036		126	U445	324TSDP4016	✓	41	U604A	182TFC6006	✓	59
U284	215TDC6029	✓	43	U354	256TFL4031	✓	126	U445A	324TSDP16002	✓	41	U605	SEE U605A		48
U285	256TDC6079	✓	43	U355	256TFL4038		126	U446	SEE U446A		41	U605A	182TFR4327	✓	48
U286	215TDC6003	✓	43	U356	254TFL4011		130	U446A	326TSDR16035		41	U606	145TTN4030		51
U287	254TDC6029	✓	43	U357	215TFR14301	✓	126	U447	SEE U447A		41	U607	SEE U607A	✓	59
U288	284TDC6079	✓	43	U360	184TFR4915	✓	125	U447A	326TSDP16005		41	U607A	182TFC6027	✓	59
U289	254TDC6003	✓	43	U363	145TFR4310	✓	125	U448	SEE U448A		41	U608	SEE U1608		48
U290	256TDC6029	✓	43	U366	215TFR14302		130	U448A	365TSDS16044		41	U609	SEE U609A	✓	59
U291	256TDC6003	✓	43	U372	184TFR4914	✓	130	U449	SEE U449A		41	U609A	182TFC6031	✓	59
U292	284TSDC6003	✓	43	U400	SEE U400A		44	U449A	365TSDS16008		41	U610	213TFC4076	✓	50
U293	286TSDC6003	✓	43	U400A	445TSDS16038	✓	44	U450	SEE U450A		41	U610A	213TFC6077	✓	59
U294	324TSDC6003	✓	43	U402	SEE U402C		41	U450A	365TSDS6074		41	U611	184TFR4003		49
U299	184TTDW4039		128	U402B	SEE U402C		41	U451	SEE U451A		41	U613	SEE U613A		59
U300	143TFR4040		125	U402C	182TTDW16010	✓	41	U451A	365TSDS16005		41	U613A	184TFC6002	✓	59
U301	143TFR4034	✓	125	U403	SEE U403A		41	U452	SEE U452A		41	U614	184TFR4005		49



Index

Catalog Number/Model Number

CAT. NO.	MODEL NO.	STOCK	PAGE NO.	CAT. NO.	MODEL NO.	STOCK	PAGE NO.	CAT. NO.	MODEL NO.	STOCK	PAGE NO.	MODEL NO.	CAT. NO.	STOCK	PAGE NO.
U615	184TTFS4005	✓	50	U670	SEE E2121		60	U797	449TSTDN16005	✓	44	U924A	145TTDR16059		37
U615A	184TTF6006	✓	59	U671	213TTFS4005	✓	50	U798	324TTDC6076	✓	43	U925	182TTDR4075		38
U616	184TTFR4038	✓	49	U671A	213TTFC6006	✓	59	U799	326TTDC6076	✓	43	U925A	182TTDW16082		38
U616A	184TTFW4727	✓	49	U672	145TTFN4080	✓	50	U815	256TTFNA14004	✓	57	U926	213TTDW4071		38
U618	SEE U618A		59	U701	SEE GT1201		66	U830	324TSTFPA14003	✓	57	U926A	213TTDW16061		38
U618A	184TTF6027	✓	59	U703	145TTFR4046		56	U834	SEE GT1236		67	U930	SEE U001A		82
U620	184TTF6030	✓	50	U704	SEE GT1204		66	U838	SEE GT1239		67	U931	SEE U039A		82
U620A	184TTF6031	✓	59	U705	145TTFR4052		55	U842	SEE GT1242		67	U933	SEE U002A		82
U621	SEE U621A		59	U706	145TTFR4070		56	U845	SEE GT1245		67	U934	SEE U040A		82
U621A	215TTF6077	✓	59	U707	SEE GT1207		66	U867	SEE U867A		68	U935	SEE U059A		82
U622	213TTFW4003		49	U708	145TTFR4126		56	U867A	182TTFN6557		68	U936	SEE U003A		82
U624	SEE U624A		59	U710	SEE GT1210		66	U868	SEE U868A		68	U937	SEE U041A		82
U624A	213TTF6002	✓	59	U713	SEE GT1213		66	U868A	184TTFN6555	✓	68	U938	SEE U060A		82
U625	213TTFW4005		49	U716	SEE GT1216		67	U869	SEE U869A		68	U939	SEE U004A		82
U627	213TTFW4028	✓	49	U718	215TTFW4033		57	U869A	213TTFN6550	✓	68	U940	213TTGS1076	✓	77
U629	SEE U629A		59	U721	254TTF4033		57	U870	SEE U870A		68	U941	184TTGS1001	✓	77
U629A	213TTF6027	✓	59	U722	SEE GT1222		67	U870A	215TTFN6546	✓	68	U942	184TTGS1026	✓	77
U630	213TTFW4030	✓	49	U723	254TTF4035		57	U871	SEE U871A		68	U943	SEE U043A		82
U631	213TTFS4030	✓	50	U724	SEE GT1225		67	U871A	254TTFNA16568	✓	68	U944	213TTGS1001	✓	77
U631A	213TTF6031	✓	59	U725	SEE GT1228		67	U872	SEE U872A		68	U945	SEE U006A		83
U632	SEE E2117		59	U726	SEE GT1231		67	U872A	256TTFNA16574	✓	68	U946	SEE E500		83
U633	SEE U633A		59	U727	SEE GT1234		67	U873	SEE U873A		68	U947	SEE U063A		83
U633A	254TTF6077	✓	59	U728	SEE GT1237		67	U873A	284TTFNA16832	✓	68	U948	SEE U007A		83
U634	215TTFW4003		49	U729	SEE GT1240		67	U874	SEE U874A		68	U949	SEE E501		83
U636	SEE U636A		60	U730	SEE GT1243		67	U874A	286TTFNA16572	✓	68	U950	SEE E502		83
U636A	215TTF6002	✓	60	U731	SEE GT1246		67	U875	SEE U875A		68	U951	254TTGN1026	✓	77
U637	215TTF4005		51	U733	143TTFR4010	✓	56	U875A	324TTF616837	✓	68	U952	SEE E504		83
U637A	215TTF6006	✓	60	U735	SEE GT1206	✓	66	U876	SEE U876A		68	U953	SEE E505		83
U638	254TTFPA4005		51	U736	182TTFR4013		56	U876A	326TTF616574	✓	68	U954	256TTGN1026	✓	77
U638A	254TTF6006	✓	60	U737	SEE GT1209		66	U877	SEE U877A		68	U955	SEE E507		83
U639	SEE U639A		60	U738	184TTFR4013		56	U877A	364TTF616558	✓	68	U956	SEE E546		83
U639A	215TTF6027	✓	60	U739	SEE GT1212		66	U878	SEE U878A		68	U957	284TTGP1026	✓	77
U640	215TTFW4030	✓	49	U740	213TTFW4007		57	U878A	365TTF616827	✓	68	U958	SEE U048A		83
U641	215TTF6030	✓	51	U741	SEE GT1215		66	U879	SEE U879A		68	U959	SEE E563		83
U641A	215TTF6031	✓	60	U742	213TTFW4008		57	U879A	405TTF616834	✓	68	U960	SEE E564		83
U642	256TTF6076	✓	51	U743	215TTFW4013		57	U880	SEE U880A		68	U961	SEE E565		83
U642A	256TTF6077	✓	60	U744	SEE GT1218		67	U880A	444TTFN16549	✓	68	U962	SEE E566		83
U643	254TTF14004		49	U746	SEE GT1221		67	U881	SEE U881A		68	U963	SEE E567		83
U644	SEE U644		60	U748	SEE GT1224		67	U881A	445TTFN16866	✓	68	U964	SEE E568A		83
U644A	254TTF6002	✓	60	U749	SEE GT1227		67	U882	SEE U882A		68	U965	SEE E569		83
U645	254TTF14005		49	U750	286TSTFPA14002	✓	57	U882A	445TTFN16852		68	U966	SEE E570		83
U646	SEE U646A		49	U757	256TTF4079		57	U884	445TTFN4575		68	U967	SEE E571		83
U646A	254TTF4027		49	U758	143TTDR6027	✓	42	U900	254TTDX4018		38	U968	SEE E572		83
U647	SEE U647B		60	U759	145TTDR6028	✓	42	U901	284TSTDP4004	✓	39	U969	364TTGS1036	✓	77
U647B	254TTF6027	✓	60	U760	145TTDR6029	✓	42	U902	286TSTDP4017		39	U970	SEE E574		83
U648	254TTFNA4030	✓	51	U763	213TTDC6026	✓	43	U903	404TTDS4042		39	U971	SEE E575		83
U648A	254TTF6031	✓	60	U764	213TTDC6001	✓	43	U903A	404TTDS16055		44	U972	365TTGS1036	✓	77
U649	SEE U649A		60	U765	215TTDC6026	✓	43	U904	405TTDS4049		39	U973	405TTGS1086	✓	77
U649A	256TTF6002	✓	60	U766	215TTDC6001	✓	43	U904A	405TTDS16060		44	U974	SEE E578		84
U650	256TTFNA4005		51	U767	254TTDC6026	✓	43	U905	145TTDR4103		37	U975	SEE E594		84
U650A	256TTF6006	✓	60	U768	254TTDC6001	✓	43	U906	145TTDR4005		37	U976	SEE E580A		84
U651	256TTF14027		49	U769	256TTDC6026	✓	43	U906A	145TTDR16008	✓	42	U977	SEE U073A		84
U652	SEE U652B		60	U770	256TTDC6001	✓	43	U907	213TTDW4078	✓	38	U978	SEE E582A		84
U652B	256TTF6027	✓	60	U771	284TTDC6026	✓	43	U908	182TTDR4106		38	U979	SEE E583		84
U653	256TTFNA4030	✓	51	U772	284TSTDC6001	✓	43	U908A	182TTDW16008	✓	42	U980	SEE E584		84
U653A	256TTF6031	✓	60	U773	286TTDC6026	✓	43	U909	324TSTDP4006		38	U981	SEE E585		84
U654	284TSTFPA4005		51	U774	286TSTDC6001	✓	43	U910	326TSTDP4003		39	U982	SEE U090A		84
U654A	284TSTFC6006	✓	60	U775	324TTDC6026	✓	43	U911	444TTDS4069		39	U984	SEE E588		84
U655	284TTFPA4028		51	U776	324TSTDC6001	✓	43	U911A	444TTDS16043		44	U985	SEE U091A		84
U659	326TTFPA4030	✓	51	U777	326TTDC6026	✓	43	U912	445TTDS4070		39	U986	SEE U986A		82
U659A	326TTF6031	✓	61	U778	326TSTDC6001	✓	43	U912A	445TTDS16041		44	U986A	143TTGN6532		82
U660	364TTF6040	✓	51	U785	447TSTDN16004	✓	44	U914	182TTDW16009	✓	42	U987	SEE U987A		82
U660A	364TTF6041	✓	61	U786	447TTDN16046	✓	44	U915	184TTDW16076	✓	42	U987A	145TTGN16532		82
U661	SEE E314		61	U788	447TSTDN16007	✓	44	U917	184TTDW16041		38	U988	SEE U988A		82
U662	SEE E316		61	U789	447TTDN16041		44	U922	143TTDR4055		37	U988A	145TTGN6550		82
U663	SEE E246		61	U790	449TTDN16077		44	U922A	143TTDR16036		37	U989	SEE U989A		82
U667	SEE E326		62	U791	447TSTDN16008	✓	44	U923	145TTDR4130		37	U989A	182TTGN6541		82
U669	SEE U669A		62	U793	449TSTDN16003	✓	44	U923A	145TTDR16054		37	U990	SEE U990A		82
U669A	445TTFN6028		62	U795	449TSTDN16004	✓	44	U924	145TTDR4136		37	U990A	184TTGN6544		82

Catalog Number/Model Number

CAT. NO.	MODEL NO.	STOCK	PAGE NO.	CAT. NO.	MODEL NO.	STOCK	PAGE NO.	CAT. NO.	MODEL NO.	STOCK	PAGE NO.	CAT. NO.	MODEL NO.	STOCK	PAGE NO.
U991	SEE U991A		83	W555	286THFNA9076		75	W636	444THFN19081		76	X070	48A11O2024	✓	149
U991A	213TTGN6540		83	W556	286THFNA19077		75	W638	145THTN19079		74	X071	48A11O2026	✓	149
U992	SEE U992A		83	W558	284TSHFNA9001	✓	75	W639	364THFS19077		75	X072	48A11T646	✓	160
U992A	215TTGN6539		83	W559	284TSHFNA9005		75	W640	365THFS19077		76	X073	48A11O11064	✓	161
U1248	182TTDW6001	✓	42	W560	284THFNA9026	✓	75	W641	445THFN19033		76	X074	48A11O11042	✓	161
U1266	182TTDW6076	✓	42	W561	284THFNA19033		75	W642	445THFN19034	✓	76	X075	48A11O11063	✓	161
U1267	184TTDW6076	✓	42	W562	324THFS9076		75	W643	326THFS19078		75	X076	48A11T11006	✓	160
U1402	SEE U402C		41	W563	324THFS9080		75	X000	48A11O1798	✓	147	X077	48A11O11066	✓	161
U1404	SEE U404B		41	W565	286TSHFNA9001	✓	75	X001	48A11O1799	✓	147	X080	48A11O2030	✓	141
U1425	182TTDW4074	✓	38	W567	286THFNA9026	✓	75	X002	48A11O1769	✓	147	X081	48A11O2031	✓	141
U1426	SEE U426B		38	W568	286THFNA19033		75	X003	48A11O2042	✓	147	X082	48A11O2033	✓	141
U1608	182TTFW4040	✓	48	W569	326THFS9076	✓	75	X004	48A11O1755	✓	147	X083	48A11O2034	✓	141
U1619	184TTFW4040	✓	49	W571	324TSHFS9001	✓	75	X005	48A11O1756	✓	147	X085	48A11O678	✓	142
U1647	SEE U647B		60	W573	324THFS9026	✓	75	X006	48A11O2001	✓	147	X086	48A8O2001	✓	142
U1652	SEE U652B		60	W574	324THFS19033		75	X009	48A11O787	✓	147	X087	48A11O2029	✓	141
U1779	364TTDCA6060	✓	43	W575	SEE W575A		75	X010	48A11O2046	✓	147	X088	48A11O2032	✓	142
U1782	364TSTDCA6001	✓	44	W575A	364THFS19087		75	X011	48A17O2005	✓	141,147	X089	48A11O2035	✓	142
U1783	365TTDCA6060	✓	44	W576	365THFS19101		75	X012	48A17O2006	✓	141,147	X090	48A11O2007	✓	142
U1784	365TSTDCA6001	✓	44	W577	326TSHFS9001		76	X013	48A17O152	✓	147	X096	48A11O840	✓	142
U1927	364TTDCA6086	✓	43	W578	326TSHFS9005		76	X014	48A17O154	✓	147	X097	48A8O182	✓	141
U1928	365TTDCA6086	✓	43	W579	326TSHFS9036		76	X015	48A17O151	✓	147	X098	48A8O181	✓	142
W501	143THTN9026	✓	74	W580	326THFS9026	✓	76	X016	48A17O153	✓	147	X099	48A11O2016	✓	142
W502	143THTN19033		74	W581	326THFS19033		76	X017	48A17O155	✓	147	X200	48A11O1060	✓	166
W503	145THTN9076		74	W582	SEE W582A		76	X018	48A11O1350	✓	147	X203	48A11O1062	✓	162
W504	182THFS19101		74	W582A	365THFS19086	✓	76	X019	48A11O1351	✓	147	X206	56A11O5310	✓	144
W505	143THTN9001		74	W583	404THFS9101		76	X020	48A11O1352	✓	147	X207	56A11O5311	✓	144
W506	143THTN9005		74	W584	364TSHFS9001	✓	76	X021	48A11O1353	✓	147	X208	56A8O5	✓	142
W507	145THTN9026	✓	74	W586	364TSHFS9026		76	X022	48A17O174	✓	147	X209	48A8O183	✓	147,165
W508	145THTN19045		74	W587	364THFS9036	✓	76	X023	48A11O1583	✓	147	X210	48A11O1068	✓	162
W509	182THTS9076		74	W588	364THFS19033		76	X024	48A17T2002	✓	103	X211	48A17O125	✓	147,163
W511	145THTN9001		74	W589	404THFS9086		76	X025	48A17T2003	✓	103	X212	48A11O1065		166
W512	145THTN19002		74	W590	405THFS19101		76	X026	48A17T2004	✓	103	X213	48A11O1524	✓	141
W513	145THTN9027	✓	74	W591	365TSHFS9001	✓	76	X027	48A11T2021	✓	103	X214	48A11O1525	✓	142
W514	145THTN19033		74	W592	365TSHFS19002		76	X028	48A11T2022	✓	103	X215	48A11O1081		166
W515	184THTS9076		74	W593	SEE W593A		76	X029	48A11T2023	✓	103	X216	48A11O1097	✓	142,165
W517	182THTS9001		75	W593A	365TSHFS19034		76	X030	48A17T118	✓	103	X218	56A11O5313	✓	166
W519	182THTS9026	✓	75	W594	365THFS9036	✓	76	X031	48A17T237	✓	103	X219	48A11O2047	✓	147
W520	182THTS19033		75	W595	365THFS9044	✓	76	X032	48A17T119	✓	103	X221	48A11O1526	✓	142
W521	213THFS9076	✓	75	W596	405THFS9086		76	X033	48A11O1674	✓	147,165	X222	48A11O1109	✓	162
W522	215THFS9101		75	W597	444THFS9101		76	X034	48A11O1773	✓	148	X223	48A11O2050	✓	162
W523	184THFS9001	✓	75	W598	405TSHFS9001	✓	76	X035	48A11O1774	✓	148	X230	48A17O136	✓	158,163
W524	184THFS19006		75	W599	405TSHFS9026		76	X036	48A11O1772	✓	148	X235	56T11D5209	✓	163
W525	184THFS9026	✓	75	W600	405THFS9036	✓	76	X037	48A11O1876	✓	148	X236	48A11O699	✓	147,162,165
W526	184THFS9030	✓	75	W601	405THFS9040	✓	76	X038	48A11O1874	✓	148	X237	48A11O694	✓	147,162
W527	215THFS9076	✓	75	W603	445THFN9106		76	X039	48A11O1875	✓	148	X241	48A11O697	✓	147,162
W528	215THFS19077		75	W604	SEE W604A		76	X040	48A17O69	✓	149	X242	48A11O756	✓	147,162
W529	254THFNA9101		75	W604A	444TSHFN19002		76	X041	48A17O70	✓	149	X251	56T34D5364	✓	154,163
W530	213THTS9001	✓	75	W606	444THFS9036	✓	76	X042	48A11O653	✓	149	X258	48A11O1167	✓	149
W531	213THTS19005		75	W607	444THFS9040	✓	76	X043	48A11O654	✓	149	X259	56T11O15	✓	164
W532	213THFS9026	✓	75	W608	445THFN9086		76	X044	48A11O655	✓	149	X260	48A11O251	✓	163
W533	213THFS9030	✓	75	W609	445THFN9102		76	X045	48A11O656	✓	149	X261	48A8O151	✓	163
W534	254THFNA9076	✓	75	W610	445TSHFN9001		76	X048	48A11O772		149	X262	48A11D245	✓	158
W536	256THFNA9101		75	W611	445TSHFN9026	✓	76	X049	48A11O773	✓	149	X263	48A11O11041		158
W537	215THFS9001	✓	75	W612	445THFN9036	✓	76	X050	48A11O774	✓	149	X264	48A11O11040		158
W538	215THFS19006		75	W613	445THFN9037		76	X052	48A11O775	✓	149	X268	48A11O1239	✓	158,167
W539	215THFS9026	✓	75	W614	445THFN9087		76	X056	48A11O901	✓	149	X269	48A17O147	✓	158,164
W540	215THFS19033	✓	75	W615	449THFS9101		76	X057	48A11O900		149	X270	48A17O149	✓	159,166
W541	256THFNA9076		75	W616	445TSHFN9005		76	X058	48A17O2001	✓	149	X271	56A11O5305	✓	144
W542	256THFNA19081		75	W617	445TSHFN9028		76	X059	48A17O2002		149	X273	48A17O161		162
W543	284THFNA19102		75	W618	445THFN9038		76	X060	48A17O2003		149	X278	48A8O206	✓	142,165
W544	254THFNA9001	✓	75	W619	449THFS9030		76	X061	48A11O2022	✓	149	X295	48A11O1410		167
W546	254THFNA9026	✓	75	W621	449THFS19092		76	X062	48A11O2009	✓	149	X297	48A11T509	✓	142,165
W547	254THFNA9030		75	W622	449THFS9088		76	X063	48A11O2028	✓	149	X298	48A11O2059	✓	142
W548	284THFNA9076	✓	75	W624	449TSHFS9003		76	X064	48A11O2011		149	X301	48A17T72	✓	159
W549	284THFNA16585		75	W626	449THFS9028		76	X065	48A11O2012	✓	149	X302	48A11T199	✓	159
W550	286THFNA19101		75	W630	449THFS19079		76	X066	48A11O2013	✓	149	X303	48A11T198	✓	159
W551	256THFNA9001	✓	75	W632	449THFS9027		76	X067	48A11O2014	✓	149	X304	48A11T201	✓	159
W553	256THFNA9026	✓	75	W634	449TSHFS9001		76	X068	48A11O2015		149	X305	48A17T2001	✓	159
W554	256THFNA19033	✓	75	W635	449THFS9036		76	X069	48A17O2004		149	X400	48A11O2017	✓	142



Index

Catalog Number/Model Number

CAT. NO.	MODEL NO.	STOCK	PAGE NO.	CAT. NO.	MODEL NO.	STOCK	PAGE NO.	CAT. NO.	MODEL NO.	STOCK	PAGE NO.	MODEL NO.	CAT. NO.	STOCK	PAGE NO.
X405	48A11O1744	✓	162	X523	56T11O5306	✓	145, 158	Y282	56H17T15527	✓	88	Y467A	182TTDW7411	✓	170
X411	48A11T2008	✓	165	X524	56T11O5307	✓	146	Y283	143THTR15535	✓	88	Y468	184TTDR7230	✓	170
X412	48A11T569	✓	143	X525	56T11O5310	✓	145, 158	Y284	145THTR15540	✓	88	Y468A	184TTDW7230	✓	170
X413	48A11T529	✓	143	X526	56T11O5309	✓	146	Y285	145THTN17034	✓	88	Y469	215TTDW7205	✓	170
X414	48A11T571	✓	143	X527	56T8O5304	✓	146	Y286	182THTL17041	✓	88	Y470	254TTDX7201	✓	170
X415	48A11T2012	✓	143	X528	56T8O5306	✓	145, 158	Y287	184THTL17038	✓	88	Y471	256TTDX7253	✓	170
X416	48A11T2013	✓	143	X529	56T8O5531	✓	145, 158	Y302	184TTDR7611	✓	105	Y472	284TTDP7205	✓	170
X417	48A11O2051	✓	147	X530	56T8O5307	✓	146	Y302A	184TTDW7611	✓	105	Y473	286TTDP7251	✓	170
X418	48A11O2052	✓	147	X531	56T8O15504	✓	145, 158	Y303	184TTDR7612	✓	105	Y485A	182TTDW7203	✓	170
X419	48A11O2053	✓	147	X532	56T11O11001	✓	145	Y304	215TTDW7301	✓	105	Y486	184TTDR7287	✓	170
X420	48A17O169	✓	141	X533	56T11O11002	✓	145	Y360	56H17T2017	✓	87	Y486A	184TTDW7287	✓	170
X422	48A17O172	✓	142	X600	48C17D2057	✓	164	Y361	56H17T2019	✓	87	Y488	213TTDW7202	✓	170
X423	48A11O2055	✓	141	X601	56C17D2101	✓	164	Y362	56H17F2017	✓	87	Y489	213TTDW7201	✓	170
X424	48A11O2054	✓	142	X602	56C17D2102	✓	164	Y363	56H17F2015	✓	87	Y490	215TTDW17206	✓	170
X426	48A11O1375	✓	142, 158	X603	56C17D5346	✓	164	Y364	56H17F2021	✓	87	Y491	215TTDW7201	✓	170
X427	48A11T2017	✓	143	X700	SEE 4722	✓	159, 166	Y365	56H17F2019	✓	87	Y492	256TTDX7207	✓	170
X428	SEE X412	✓	143	X701	SEE 4404	✓	159, 166	Y366	145THTR5329	✓	87	Y493	284TTDP7202	✓	170
X429	48A11T2020	✓	143	X900	SEE H247	✓	104	Y367	145THFR5330	✓	87	Y500	56H17T2011	✓	87
X430	48A11T463	✓	143	X902	56B17F5324	✓	103	Y368	145THFR5329	✓	87	Y501	56H17T2012	✓	87
X431	48A11O1461	✓	145	X903	SEE X1903	✓	104	Y369	145THFR5330	✓	87	Y502	56H17T2013	✓	87
X432	56A11O29	✓	143	X904	SEE X1904	✓	104	Y370	182THFR5329	✓	88	Y503	56H17T2014	✓	87
X433	56A11O30	✓	143	X905	SEE C1314	✓	104	Y371	182THFR5330	✓	88	Y504	56H17T2015	✓	87
X440	48A11O2065	✓	142	X906	SEE C1315	✓	104	Y372	184THFR7726	✓	88	Y505	56H17T2016	✓	87
X441	48A11O2062	✓	142	X908	SEE C1909	✓	104	Y373	184THFR7736	✓	88	Y506	56H17F2011	✓	87
X442	48A11O2064	✓	142	X909	48S17T2004	✓	106	Y373A	184THFR7736	✓	88	Y507	56H17F2012	✓	87
X443	48A11O2063	✓	142	X910	48S17T366	✓	106	Y374	56H17T2018	✓	87	Y508	56H17F2013	✓	87
X444	48A11O1596	✓	142	X911	48S17T365	✓	106	Y375	56H17T2020	✓	87	Y509	254THNA8058	✓	91
X445	48A11O1732	✓	144	X912	56B17T5303	✓	103	Y376	56H17F2018	✓	87	Y510	256THNA8038	✓	91
X446	48A11O1643	✓	144	X913	56B17T20	✓	103	Y377	56H17F2016	✓	87	Y511	284THFPA8038	✓	91
X447	48A11O1642	✓	144	X920	48A17T2005	✓	167	Y378	56H17F2022	✓	87	Y512	286THFPA8038	✓	91
X448	56A11O5314	✓	144	X921	48A17T2006	✓	167	Y379	56H17F2020	✓	87	Y513	324THFPA8038	✓	91
X449	56A11O5315	✓	144	X922	48A17T2007	✓	167	Y380	184TTF57290	✓	169	Y514	326THFPA8038	✓	91
X450	48A8T71	✓	143	X923	48A11T2024	✓	167	Y381	213TTF57238	✓	169	Y515	364THFS8046	✓	91
X451	48A8T72	✓	143	X924	48A11T2025	✓	167	Y382	215TTF57290	✓	169	Y516	365THFS8046	✓	91
X452	48A8T73	✓	143	X925	48A11T2026	✓	167	Y383	254TTFNA7210	✓	169	Y517	405THFS8046	✓	92
X453	48A11O1771	✓	142	X1903	5KH32FNA499S	✓	104	Y384	256TTFNA7250	✓	169	Y518	444THFN8046	✓	92
X454	48A17O250	✓	142	X1904	5KH33JNA500S	✓	104	Y385	284TTFNA7240	✓	169	Y519	445THFN8046	✓	92
X455	48A11O1770	✓	142	Y201	215TTDW7376	✓	173	Y386	286TTFNA7260	✓	169	Y520	445THFN8050	✓	92
X456	48A11T578	✓	143	Y202	215TTDW7377	✓	173	Y387	324TTF57290	✓	169	Y521	56H17F2014	✓	87
X457	48A11T579	✓	143	Y203	254TTDX7377	✓	173	Y388	326TTF59210	✓	169	Y522	145THFR5328	✓	87
X458	48A11T580	✓	143	Y204	256TTDX7391	✓	173	Y389	364TTF59234	✓	169	Y523	145THFR5326	✓	87
X459	48A11T581	✓	143	Y209	365TTDS7383	✓	173	Y390	365TTF59230	✓	169	Y525	143THN8028	✓	91
X462	48A11T619	✓	143	Y210	404TTDS7387	✓	173	Y391	405TTF57297	✓	169	Y526	145THN8029	✓	91
X463	48A17T356	✓	143	Y211	405TTDS7697	✓	173	Y392	444TTF57262	✓	169	Y527	182THS8028	✓	91
X464	48A17T359	✓	143	Y212	444TTDS8699	✓	173	Y393	286THNA7026	✓	89	Y530	182THFR5326	✓	88
X465	48A8T11002	✓	143	Y213	445TTDS9477	✓	173	Y394	286THNA7036	✓	89	Y531	449THFS8046	✓	92
X466	48A17T86	✓	143	Y215	284TTDP7692	✓	173	Y395	284THFPA8086	✓	91	Y532	449THFS8047	✓	92
X467	48A17T87	✓	143	Y216	286TTDP7689	✓	173	Y409	182TTDR7211	✓	170	Y533	449THFS8048	✓	92
X468	48A17T96	✓	143	Y217	324TTDP7687	✓	173	Y409A	182TTDW7211	✓	170	Y534	56H17T5301	✓	89
X469	48A11T276	✓	143	Y218	326TTDP7697	✓	173	Y412	184TTDR7215	✓	170	Y535	56H17T5302	✓	89
X470	48A11O885	✓	165	Y219	505UTDS1584	✓	173	Y412A	184TTDW7215	✓	170	Y536	143THFR5326	✓	89
X471	48A11O1044	✓	148	Y220	505UTDS1590	✓	173	Y415	215TTDW7203	✓	170	Y537	145THTR5376	✓	89
X472	48A11O1045	✓	148	Y250	---	✓	86	Y418	254TTDX7208	✓	170	Y538	145THTR5326	✓	89
X473	48A11O1046	✓	148	Y251	---	✓	86	Y449	145TTDR5703	✓	170	Y540	184THTL7776	✓	89
X474	48A11O1047	✓	148	Y252	---	✓	86	Y450	145TTDR5704	✓	170	Y541	182THTL7726	✓	89
X475	48A17O123	✓	148	Y253	---	✓	86	Y451	145TTDR5705	✓	170	Y542	213THTL7776	✓	89
X476	48A17O124	✓	148	Y254	---	✓	86	Y452	145TTDR5706	✓	170	Y543	184THTL7726	✓	89
X477	48A17O128	✓	148	Y255	---	✓	86	Y453	182TTDR7413	✓	170	Y544	215THTL7776	✓	89
X500	56T11O5300	✓	146	Y256	---	✓	86	Y454	184TTDR7286	✓	170	Y545	213THTL7726	✓	89
X501	56T11O5301	✓	146	Y257	---	✓	86	Y454A	184TTDW7286	✓	170	Y546	254THL5776	✓	89
X502	56T11O5302	✓	146	Y258	---	✓	86	Y455	215TTDW7204	✓	170	Y547	215THTL7726	✓	89
X503	56T11O5303	✓	146	Y259	---	✓	86	Y456	254TTDX7278	✓	170	Y548	256THL5776	✓	89
X506	56T8O5301	✓	146	Y260	---	✓	86	Y457	256TTDX7263	✓	170	Y549	254THL5726	✓	89
X507	56T8O5302	✓	146, 158	Y261	---	✓	86	Y458	256TTDX7264	✓	170	Y551	145THN6046	✓	89
X509	56T11O5304	✓	146	Y262	---	✓	86	Y459	284TTDP7221	✓	170	Y552	256THNA7026	✓	89
X511	56T8O5303	✓	146	Y263	---	✓	86	Y460	286TTDP7217	✓	170	Y553	284THNA7026	✓	89
X512	56T11O15511	✓	145	Y270	182THFR7730	✓	88	Y465	145TTDR5701	✓	170	Y555	56H17T5311	✓	89
X513	56T11O5305	✓	145	Y280	56H17T15526	✓	88	Y466	145TTDR5702	✓	170	Y556	56H17T5312	✓	89
X522	56T11O5308	✓	146	Y281	56H17T15528	✓	88	Y467	182TTDR7411	✓	170	Y557	145THN6060	✓	89

Catalog Number/Model Number

CAT. NO.	MODEL NO.	STOCK	PAGE NO.	CAT. NO.	MODEL NO.	STOCK	PAGE NO.	CAT. NO.	MODEL NO.	STOCK	PAGE NO.	CAT. NO.	MODEL NO.	STOCK	PAGE NO.
Y558	182THL7736	✓	89	Y905	---		86	Y994	213THFW7726	✓	88	Z427	SEE Z427A		126
Y559	184THL7736	✓	89	Y906	---		86	Y995	213THFW7736		88	Z427A	184TBDW17011	✓	126
Y560	213THL7736	✓	89	Y907	---		86	Y996	215THFW7726	✓	88	Z428	213TCDW7028		126
Y561	215THL7736	✓	89	Y908	---		86	Y997	215THFW7736		88	Z429	213TCDW7003	✓	126
Y562	254THL5736	✓	89	Y910	---		86	Y998A	182HTW7726		88	Z430	215TBDW7045		126
Y563	256THNA7036	✓	89	Y911	---		86	Y999	182THFR7729	✓	88	Z431	215TCDW7004	✓	126
Y564	184THS8028	✓	91	Y912	---		86	Y1270	182THFW7730	✓	88	Z432	215TBDW7030		126
Y565	213THS8038	✓	91	Y913	---		86	Y1303	184TTDW7612	✓	105	Z433	184TBFR7315	✓	118
Y566	215THS8038	✓	91	Y914	---		86	Y1372	184THFW7726	✓	88	Z433A	184TBFW7315	✓	118
Y567	284THNA7036	✓	89	Y915	---		86	Y1453	182TTDW7413	✓	170	Z434	213TBFW7010	✓	118
Y569	284THFA8028	✓	91	Y916	---		86	Y1484	182TTDW7412	✓	170	Z435	215TBFW7010	✓	118
Y570	286THFA8028	✓	91	Y917	---		86	Y1487	184TTDW7209	✓	170	Z502	184TBDR5326	✓	168
Y571	324THFA8028	✓	91	Y918	---		86	Y1999	182THFW7729	✓	88	Z504	184TBDR5301	✓	168
Y572	326THFS8028	✓	91	Y920	---		86	Z112	SEE Z112A		102	Z506A	184TBDW7656		168
Y573	364THFS8036	✓	91	Y921	---		86	Z112A	182TCFW9061	✓	102	Z602	56E17F1001	✓	94
Y574	365THFS8036	✓	91	Y922	---		86	Z113	SEE Z113A		102	Z603	56E17F1002	✓	94
Y575	405THFS8036	✓	92	Y923	---		86	Z113A	184TCFW9057	✓	102	Z604	56E17F1003	✓	94
Y576	444THFN8036	✓	92	Y924	---		86	Z114	SEE Z114A		102	Z605	56E17F1004	✓	94
Y577	445THFN8036	✓	92	Y925	---		86	Z114A	184TBFW7070	✓	102	Z606	56E17F1005	✓	94
Y578	445THFN8040	✓	92	Y926	---		86	Z115	215TBFW7028	✓	102	Z607	56E17F1006	✓	94
Y579	449THFS8036		92	Y927	---		86	Z116	215TBFW7044	✓	102	Z610	56E17F1007	✓	94
Y580	449THFS8037		92	Y928	---		86	Z117	213TBFW7027	✓	102	Z611	56E17F1008	✓	94
Y582	286THFA8086		91	Y929	---		86	Z118	145TBFR5328	✓	101	Z612	56E17F2005	✓	94
Y583	324THFA8086		91	Y930	---		86	Z119	SEE Z119A		101	Z613	56E17F2006	✓	94
Y584	326THFA8086		91	Y931	---		86	Z119A	182TCFW7072	✓	101	Z614	56E17F2007	✓	94
Y585	364THFS8391		91	Y932	---		86	Z120	SEE Z120A		101	Z615	145TEFR5326	✓	94
Y586	365THFS8380		91	Y933	---		86	Z120A	184TBFW17045	✓	101	Z616	145TEFR5327	✓	94
Y587	404THFS8092		91	Y934	---		86	Z121	SEE Z121A		101	Z617	182TEFR5326	✓	94
Y588	405THFS8378	✓	91	Y935	---		86	Z121A	184TBFW7737	✓	101	Z630	56E17V2001	✓	95
Y589	444THFN8384	✓	92	Y936	---		86	Z122	215TBFW7029	✓	101	Z631	56E17V2002		95
Y590	145HTN8037	✓	91	Y937	---		86	Z123	143TCFR5328	✓	101	Z634	56E17V2003	✓	95
Y592	56H17T2001	✓	89	Y938	---		86	Z125	215TBDR7361		141	Z635	56E17V2004	✓	95
Y595	213THFS8028	✓	91	Y939	---		86	Z126	215TBDW7362		141	Z636	56E17V2005	✓	95
Y596	215THFS8029	✓	91	Y940	---		86	Z127	256TBDX7028		141	Z637	56E17V2006		95
Y597	254THFA8038	✓	91	Y941	---		86	Z128	145TBFR5341	✓	101	Z638	56E17W2001	✓	95
Y598	256THFA8038	✓	91	Y942	---		86	Z304	145TBDR5309	✓	105	Z639	56E17W2002	✓	95
Y600	56H17E5301	✓	90	Y943	---		86	Z305	184TCDR7615	✓	105	Z641	56E17W2003		95
Y601	56H17E5302	✓	90	Y944	---		86	Z305A	184TCDW7615	✓	105	Z660	56E17T2001	✓	95
Y602	56H17E5303	✓	90	Y945	---		86	Z306	184TCDR7617	✓	105	Z662	56E17T2002	✓	95
Y603	56H17E5304	✓	90	Y946	---		86	Z306A	184TCDW7617	✓	105	Z663	56E17T2003	✓	95
Y604	56H17E5305	✓	90	Y947	---		86	Z307	SEE Z307A		105	Z664	56E17T2004	✓	95
Y605	56H17T2021		87	Y948	---		86	Z307A	184TBDW7009	✓	105	Z665	56E17T2005	✓	95
Y606	56H17T2022	✓	87	Y949	---		86	Z308	215TCDW7003	✓	105	Z666	56E17F2008	✓	95
Y621	SEE U501		134	Y950	---		86	Z309	182TCDR7013		105	Z667	56E17F2009	✓	95
Y623	SEE U503		134	Y951	---		86	Z314	215TCDW7012		105	Z668	56E17F2010	✓	95
Y624	SEE U504		134	Y952	---		86	Z313	184TBDR7324		105	Z669	56E17F2011	✓	95
Y625	SEE U505		134	Y953	---		86	Z315	215TBDW7013		105	Z1124	184TBDW7369		141
Y627	SEE U507		134	Y954	---		86	Z401	143TCDR5328		118				
Y629	SEE U509		134	Y955	---		86	Z403	145TCDR5328		118				
Y631	SEE U511		134	Y956	---		86	Z404	145TBDR5304		118				
Y633	SEE U513		134	Y957	---		86	Z405	182TCDR7074	✓	118				
Y635	SEE U515		134	Y958	---		86	Z405A	182TCDW7074	✓	118				
Y637	326TSTDP8219	✓	134	Y978	143THEN8034		92	Z406	182TCDR7318	✓	118				
Y639	SEE U519		134	Y979	145THEN8034	✓	92	Z406A	182TCDW7318	✓	118				
Y641	SEE U538		134	Y980	182THES8048	✓	92	Z407	184TCDR7047	✓	118				
Y643	SEE U523		134	Y981	213THES8053	✓	92	Z407A	184TCDW7047	✓	118				
Y645	SEE U525		135	Y982	254THEN8058	✓	92	Z408	184TCDR7011	✓	118				
Y647	SEE U527		135	Y983	254THEN8059	✓	92	Z408A	184TBDW17007	✓	118				
Y649	SEE U529		135	Y984	256THEN17031		92	Z409	213TCDW7027	✓	118				
Y651	404TSTDS7623	✓	135	Y985	284THEN8032		92	Z410	213TCDW7002	✓	118				
Y658	SEE U539		135	Y986	143HTN8036	✓	93	Z411	215TBDW7029	✓	118				
Y659	SEE U540		135	Y987	145HTN8043	✓	93	Z412	215TCDW7002	✓	118				
Y663	SEE U521		134	Y988	182THS8048	✓	93	Z413	215TBDW7027	✓	118				
Y900	---		86	Y989	184THS8056	✓	93	Z420	143TCDF5330		126				
Y901	---		86	Y990	213THS8071	✓	93	Z422	145TCDF5329		126				
Y902	---		86	Y991	215THS8071	✓	93	Z424	182TCDF7354		126				
Y903	---		86	Y992	254HTNA8071	✓	93	Z425	182TCDF8005		126				
Y904	---		86	Y993	256HTNA8071	✓	93	Z426	184TCDF7626		126				



Index

Model Number/Catalog Number

MODEL NO.	CAT. NO.	STOCK	PAGE NO.	MODEL NO.	CAT. NO.	STOCK	PAGE NO.	MODEL NO.	CAT. NO.	STOCK	PAGE NO.	MODEL NO.	CAT. NO.	STOCK	PAGE NO.
003062.09	A960A	✓	200	5K42HN4139	K553	✓	116	5K49MN4114	K525	✓	153	5K49ZN4611	K644	✓	40
5K32GN30	K151	✓	47	5K42JN3050	K546	✓	154	5K49MN4618X	K608	✓	68	5K49ZN4616	K648	✓	41
5K32GN48	K281	✓	153	5K42JN3051	K544	✓	154	5K49MN4620X	K607	✓	68	5K49ZN6433S	K1520	✓	146
5K32GN53	K418	✓	47	5K42JN4163	K318	✓	36	5K49MN6020	K1316	✓	53	5K32GN13	C247	✓	153
5K32GNB249X	K717	✓	79	5K46HN2546	K690	✓	41	5K49MN6079	K159	✓	47	5K32GN19	G1312	✓	29
5K33FN30	K153	✓	47	5K46KN2082	K1484	✓	116	5K49MN6080	K285	✓	153	5K32GN19X	CG251	✓	29
5K33GN45	K275	✓	154	5K46KN2172	K223	✓	116	5K49MN6081	K541	✓	153	5K32GN25	G1511	✓	31
5K33JNA943	K253	✓	53	5K46KN2173	K222	✓	40,116,157	5K49MN6126T	K1487	✓	159	5K32GN9	C242	✓	29
5K33KN52	K283	✓	153	5K46KN2175	K166	✓	48	5K49MN6369	K526	✓	99	5K32GN9X	C243	✓	29
5K33KN67	K522	✓	53	5K46KN4031	K1308	✓	41	5K49MN6382X	K2116	✓	79	5K33FN31	C1419	✓	31
5K33KN92	K194	✓	47	5K46KN4071	K119	✓	36	5K49MN6432S	K1500	✓	146	5K33FN4180X	C1336	✓	115
5K35FN101	K748	✓	116	5K46KN4085	K277	✓	154	5K49MN8349X	K2107	✓	79	5K33KN19	C462	✓	29
5K35FN2	K113	✓	36	5K46KN4085X	K1410	✓	154	5K49NN2046	K1311	✓	41	5K33MN2502X	C1089	✓	114
5K35FN55	KG215	✓	40,116,157	5K46KN4125	K250	✓	40	5K49NN2147X	K1416	✓	154	5K33MN2555X	C1083	✓	114
5K35JN198	K527	✓	36	5K46KN4141	K555	✓	116	5K49NN2178	K225	✓	116	5K33MN2889X	C1463	✓	114
5K35JN47	K230	✓	117	5K46LN6033S	K378	✓	146	5K49NN2180	K224	✓	40,116,157	5K35FN51X	C208	✓	24
5K35MN294	K282	✓	153	5K46LN6428S	K1505	✓	146	5K49NN4052T	K1438	✓	106	5K35GNA488	CG382	✓	171
5K35MN75	K321	✓	47	5K46MN4072	K122	✓	36	5K49NN4580X	K2111	✓	79	5K35JN10	C147	✓	21
5K35MNB114	K254	✓	53	5K46MN4087	K278	✓	154	5K49NN4581X	K2115	✓	80	5K35JN10X	C148	✓	21
5K35MNB117	K158	✓	47	5K46MN4087X	K1412	✓	154	5K49PN2330	KG236	✓	117	5K35JN12	C200	✓	24
5K36JN2	K115	✓	36	5K46MN4126	K251	✓	40	5K49PN2348	KG235	✓	53	5K35JN12X	CG201	✓	24
5K36JN56	K217	✓	116	5K46MN4144	K750	✓	116	5K49PN3052	K280	✓	154	5K35JN23X	C129	✓	26
5K36JN57	K216	✓	40,116,157	5K46MN4623	K635	✓	41	5K49PN3053	K279	✓	154	5K35JN27Y	CG105	✓	23
5K36MN339	KG232	✓	117	5K46MN6018	K1299	✓	40	5K49PN4088X	K1415	✓	154	5K35JN7	G1114	✓	24,152
5K36MN4152	K633	✓	53	5K46PN6082	K162	✓	47	5K49PN4113	K198	✓	47	5K35JN70X	C354	✓	27
5K36PN251	G1340	✓	47	5K48TN2181	K227	✓	116	5K49PN4120	K521	✓	40	5K35JN7X	G1115	✓	24,152
5K36PN254	K523	✓	53	5K48TN2182	K226	✓	40,116,157	5K49PN4121	K751	✓	116	5K35JNA489	CG383	✓	171
5K36PN30	K155	✓	47	5K48TN6119S	K1486	✓	145,158	5K49PN4564	K458	✓	99	5K35JNA489Y	CG384	✓	171
5K36PN345S	K1403	✓	146	5K48TN6430S	K1515	✓	146	5K49PN4565	K460	✓	99	5K35MN145	C1405	✓	32
5K36PNB111	K161	✓	47	5K48UN3056	K520	✓	154	5K49PN6019	K1300	✓	40	5K35MN43	G1330	✓	29
5K36PNB116	K255	✓	53	5K48UN3057	K549	✓	154	5K49PN6025	K1317	✓	53	5K35MN43X	G1331	✓	29
5K37MN252X	K1409	✓	154	5K48WN3013S	K1482	✓	146,158	5K49PN6164	K1490	✓	53	5K35MN73	G1513	✓	31
5K37MN3543	K1483	✓	116	5K48WN3181S	K1511	✓	146,158	5K49PN8030	K1318	✓	53	5K36GN2507X	C1168	✓	114
5K37MN37	K218	✓	40,116,157	5K49DN4130	K252	✓	53	5K49QN4609	K640	✓	54	5K36JN266	G1098	✓	21
5K37MN38	KG219	✓	116	5K49DN4131	K439	✓	47	5K49RN4570	K1494	✓	99	5K36JN267	C219	✓	21
5K37NN30	K160	✓	47	5K49DN4132	K247	✓	40	5K49RN4617	K646	✓	41	5K36JN268X	C330	✓	115,157
5K38PN258X	K1411	✓	154	5K49FN2045	K1306	✓	41	5K49RN4621X	K610	✓	68	5K36JN269X	C331	✓	115
5K38PN47	K220	✓	40,116,157	5K49FN4129	K196	✓	47	5K49RN6034S	K379	✓	146	5K35JN8X	C145	✓	21
5K38PN48	K221	✓	116	5K49FN4136	K154	✓	47	5K49RN6118S	K1485	✓	145	5K36LN1	C215	✓	24
5K38RN106	K500	✓	55	5K49FN4138	K248	✓	40	5K49RN6429S	K1510	✓	146	5K36LN144	C1420	✓	32
5K38RN30	K163	✓	47	5K49FN6381X	K2101	✓	79	5K49SN2184	K238	✓	117	5K36LN144X	C444	✓	32
5K38RN49	KG234	✓	117	5K49HN2507X	K2108	✓	79	5K49SN2187	KG237	✓	53	5K36LN166X	C349	✓	31
5K38SN267S	K1404	✓	146	5K49HN6385X	K2104	✓	79	5K49SN3054	K518	✓	154	5K36LN18	C431	✓	21
5K39SNB505S	K1402	✓	146	5K49JN4051T	K1476	✓	106	5K49SN3055	K519	✓	154	5K36LN19X	C460	✓	24
5K39SNB587S	K1407	✓	146	5K49JN4560X	K2103	✓	79	5K49SN4117	K257	✓	53	5K36LN1X	C216	✓	24,152
5K39SNB765T	K1405	✓	146	5K49JN4574X	K2105	✓	79	5K49SN4118	K167	✓	48	5K36LN26	C209	✓	24
5K42FN4033	K1305	✓	41	5K49JN4576X	K2112	✓	80	5K49SN4119	K260	✓	56	5K36LN26X	C210	✓	24
5K42FN4035	K1322	✓	55	5K49JN4577X	K2113	✓	80	5K49SN8050	K408	✓	37	5K36LN30	C153	✓	21
5K42GN4619X	K606	✓	68	5K49JN4582X	K2102	✓	79	5K49TN4622X	K609	✓	68	5K36LN30X	C154	✓	21
5K42HN4032	K1307	✓	41	5K49KN2150X	K1413	✓	154	5K49TN6383X	K2110	✓	79	5K36LN4003Y	C664	✓	29
5K42HN4034	K1324	✓	55	5K49KN4124	K258	✓	55	5K49UN4086X	K1418	✓	154	5K36LN7	C158	✓	21
5K42HN4089	K381	✓	154	5K49KN4142	K286	✓	153	5K49UN4566	K461	✓	99	5K36LN7X	C159	✓	21
5K42HN4089X	K1408	✓	154	5K49KN4563	K457	✓	99	5K49UN4567	K462	✓	99	5K36LN83	C355	✓	27
5K42HN4106	K116	✓	36	5K49KN4573	K456	✓	99	5K49UN4569	K459	✓	99	5K36LN83X	C356	✓	27
5K42HN4109	K197	✓	47	5K49LN4578X	K2114	✓	80	5K49UN6085	K165	✓	47	5K36LN84X	C683	✓	115
5K42HN4127	K249	✓	40	5K49MN4104	K256	✓	53	5K49UN8052	KG319	✓	176	5K36MN20	OG393	✓	23
5K42HN4128	K284	✓	153	5K49MN4105	K164	✓	47	5K49WN4335X	K1497	✓	154	5K36MN2508X	C1169	✓	114
5K42HN4133	K550	✓	117	5K49MN4110	K259	✓	55	5K49ZN2190	K240	✓	117	5K36MN27X	C133	✓	26
5K42HN4134	K426	✓	47	5K49MN4111	K424	✓	47	5K49ZN24252	K1492	✓	48	5K36PNB169X	C646	✓	34
5K42HN4137	K469	✓	53	5K49MN4112	K524	✓	53	5K49ZN4253	K1491	✓	53	5K37EN3900U	4788	✓	156

Model Number/Catalog Number

MODEL NO.	CAT. NO.	STOCK	PAGE NO.	MODEL NO.	CAT. NO.	STOCK	PAGE NO.	MODEL NO.	CAT. NO.	STOCK	PAGE NO.	MODEL NO.	CAT. NO.	STOCK	PAGE NO.
5KC37FN65X	C329	✓	115	5KC46LN0252Y	C1461	✓	171	5KC49PN3027X	C419	✓	25,152	5KCR39UN2505X	C1092	✓	114
5KC37FN71X	J1025	✓	115,157	5KC46LN0254X	C1483		26	5KC49PN3036	C248	✓	29	5KCR39UN2511X	C1172	✓	114
5KC37HN3898U	4781		156	5KC46LN0269X	4686	✓	152	5KC49PN6051	C1258	✓	24	5KCR39UN2512X	C1173	✓	114
5KC37LN502Y	C1474	✓	21	5KC46NN0758Y	C1298	✓	21	5KC49PN6051X	C548	✓	24	5KCR39UN2558X	C1086	✓	114
5KC37LN91	CG111	✓	23	5KC46PN0015	C268	✓	29	5KC49PN6062	C1333	✓	29	5KCR39UN2892X	C1466	✓	114
5KC37MN96	C459	✓	21	5KC46PN0015X	C269	✓	29	5KC49PN6070	C1252	✓	21	5KCR46JN0083X	E252	✓	28
5KC37NN115X	C847	✓	115	5KC46PN0032	G1517	✓	31	5KC49QN0716X	C1807	✓	34	5KCR46JN0083Y	E250	✓	28
5KC37NN14T	C457	✓	24	5KC46PN0062Y	F34E1	✓	101	5KC49QN0718X	C1816	✓	35	5KCR46JN0084	E251	✓	27
5KC37NN15	C164	✓	21	5KC46PN0035Y	C1489	✓	171	5KC49QN0724	C1288	✓	107	5KCR46JN0085	E253	✓	21
5KC37NN160	C449	✓	23	5KC47NN0723	C1286	✓	107	5KC49QN4559X	C1810	✓	34	5KCR46JN0086X	E254	✓	24
5KC37NN3544T	C1467	✓	140	5KC48TN2169	C187	✓	22	5KC49RN2152T	C1159	✓	25,152	5KCR46JN0087X	E257	✓	32
5KC37NN501Y	C1475	✓	21	5KC48UN6052	C1264	✓	24	5KC49RN2513	C1289	✓	107	5KCR46JN0087Y	E255	✓	32
5KC37RN35	CG260	✓	29	5KC48UN6052X	C552	✓	24	5KC49RN2520Y	C703	✓	22	5KCR46JN0088	E256	✓	31
5KC38NN410X	C1155	✓	24,152	5KC48UN6072	C1422	✓	27	5KC49SN2156X	C855	✓	31	5KCR46JN0089	E258	✓	29
5KC38NN413X	C1154	✓	24,152	5KC48UN6073	C1263	✓	21	5KC49SN2158	C1424	✓	31	5KCR46MN0054X	E263	✓	24
5KC38PN2509X	C1170	✓	114	5KC49GN0001	B1316	✓	24,152	5KC49SN2418U	C662	✓	30	5KCR46MN0055X	E266	✓	32
5KC38RN4153Y	C702	✓	21	5KC49GN0001X	CG223	✓	24	5KC49SN2537Y	C1269	✓	28	5KCR46MN0055Y	E264	✓	32
5KC38RN60	C179	✓	21	5KC49GN0009	C358	✓	27	5KC49SN6375X	C1809		34	5KCR46MN0090X	E261	✓	28
5KC38RN60X	C180	✓	21	5KC49GN0009X	C359	✓	27	5KC49SN6380X	C1817	✓	35	5KCR46MN0090Y	E259	✓	28
5KC38SN2510X	C1171	✓	114	5KC49GN0010	C167	✓	21	5KC49SN8060T	C1273	✓	140	5KCR46MN0091	E260	✓	27
5KC39EN2500X	C1087	✓	114	5KC49GN0010X	C168	✓	21	5KC49TN0033	C295	✓	30	5KCR46MN0092	E262	✓	21
5KC39EN2553X	C1081	✓	114	5KC49GN0010Y	C169	✓	21,168	5KC49TN0034	C275	✓	30	5KCR46MN0093	E265	✓	31
5KC39HN2501X	C1088	✓	114	5KC49GN0022X	C1153	✓	24,152	5KC49TN0034X	C276	✓	30	5KCR46MN0094	E267	✓	29
5KC39HN2554X	C1082	✓	114	5KC49HN0719X	C1803	✓	34	5KC49TN0035	G1519	✓	31	5KCR46NN0264T	C1303	✓	104
5KC39HN2888X	C1462	✓	114	5KC49HN2509X	C1814	✓	35	5KC49TN0063Y	F10E1	✓	101	5KCR48QN0725	C1290	✓	107
5KC39NN50X	C332	✓	115,157	5KC49LN6386X	H891	✓	34	5KC49TN0067	C376	✓	32	5KCR48TN2142T	C340	✓	115,157
5KC39QN3218X	C465	✓	115	5KC49MN2043Y	9031	✓	21,168	5KC49TN0285X	C292	✓	153	5KCR48TN2174T	C341	✓	115
5KC39QN3219X	C333	✓	115	5KC49MN2049Y	9032	✓	21,168,174	5KC49TN0568Y	C660	✓	30	5KCR48TN2650Y	9035	✓	22,23,168
5KC39QN3220X	C1152	✓	24,152	5KC49MN6061	G1316	✓	29	5KC49TN2141X	C338	✓	115,157	5KCR48TN3084X	C1479	✓	25,152
5KC39RN114T	CG732	✓	115	5KC49MN6063	C1423		31	5KC49TN2170X	C339	✓	115	5KCR48TN8062	C194	✓	22
5KC39RN383X	C1157	✓	24,152	5KC49MN6379X	C1818	✓	35	5KC49UN6065	C264	✓	29	5KCR48UN0102Y	EG277	✓	28
5KC39RN44X	C334	✓	115,157	5KC49MN6384X	C1801	✓	34	5KC49UN6067	C1404	✓	31	5KCR48UN0104	E280	✓	21
5KC39RN45X	C335	✓	115	5KC49NN0061T	4688	✓	152	5KC49UN6067	C1270	✓	28	5KCR48UN0105X	E281	✓	24
5KC39SN2810X	C1084	✓	114	5KC49NN0221X	9029	✓	23	5KCP100EZA001X	4777	✓	156	5KCR48UN2653Y	9036	✓	22,168
5KC39SN2812X	C1090	✓	114	5KC49NN0222X	9030		174	5KCP33GNA471S	P239	✓	106	5KCR48UN2654Y	9040	✓	168
5KC39SN2890X	C1464	✓	114	5KC49NN0224X	C1187	✓	24	5KCP35CNA490S	PG240	✓	159	5KCR48WN0273	G1376	✓	30
5KC42GN0014	C261	✓	29	5KC49NN2044Y	9034	✓	23	5KCP35KNB057S	P250	✓	104	5KCR48WN0273X	G1377	✓	30
5KC42GN0014X	C262	✓	29	5KC49NN2050Y	9033	✓	21,168	5KCP35KNB650U	P254	✓	171	5KCR48WN0273Y	F100	✓	101
5KC42GN0018	G1515	✓	31	5KC49NN2081T	C1468	✓	140	5KCP35NNA670T	P247	✓	171	5KCR48WN0292	C297	✓	30
5KC42GN0018X	C446	✓	31	5KC49NN2130X	C273	✓	30	5KCP36NNB059S	P251	✓	104	5KCR48WN0292Y	F15E1		101
5KC42GN0051Y	F13E1	✓	101	5KC49NN2130Y	C274	✓	30	5KCP36NNB670U	PG252	✓	171	5KCR48WN0294	G1531	✓	31
5KC42GN0066	C375	✓	32	5KC49NN2132X	C445	✓	32	5KCP36NNB671U	P253	✓	171	5KCR48WN0566Y	C659	✓	30
5KC42GN0309X	C289	✓	153	5KC49NN2133X	C351	✓	31	5KCP36RNA491S	P241	✓	159	5KCR48WN0756Y	C1299		22,168
5KC46GN0050Y	F12E1	✓	101	5KC49NN2135X	C352	✓	115	5KCP39SNB480S	P193	✓	144	5KCR48WN6066	C271	✓	29
5KC46GN0075U	C1291	✓	102	5KC49NN2140X	C336	✓	115,157	5KCP39SNB481S	P194	✓	144	5KCR49PN0077U	C1293	✓	102
5KC46GN0251	C1458	✓	171	5KC49NN2167X	C337	✓	115	5KCP39SNB482S	P195	✓	144	5KCR49PN0095X	E270	✓	28
5KC46GN0251Y	C1459	✓	171	5KC49NN2419Y	C663	✓	30	5KCP39TNB763T	P196	✓	144	5KCR49PN0095Y	E268	✓	28
5KC46GN0569Y	C661	✓	29	5KC49PN0155	C235	✓	24,152	5KCP39UNB764T	P198	✓	144	5KCR49PN0096	E269	✓	27
5KC46JN0002X	C138	✓	24	5KC49PN0155X	CG236	✓	24	5KCP39UNB767T	P197	✓	144	5KCR49PN0097	EG271	✓	21
5KC46JN0076U	C1292	✓	102	5KC49PN0161	C181	✓	21	5KCP49PN9812S	P245	✓	144	5KCR49PN0098X	EG272	✓	24
5KC46JN0722	C1285	✓	107	5KC49PN0161U	C1480	✓	21,168,174	5KCP49UN9612S	P184	✓	144	5KCR49PN0099X	E275	✓	32
5KC46LN0149X	C1156	✓	24,152	5KC49PN0161X	C182	✓	21	5KCP49UN9614S	P185	✓	144	5KCR49PN0099Y	EG273	✓	32
5KC46LN0153	C175	✓	21	5KC49PN0162	C188	✓	21	5KCP49UN9811S	P246	✓	144	5KCR49PN0100	E274	✓	31
5KC46LN0153U	C177	✓	21	5KC49PN0163X	CG363	✓	27	5KCP49UN9837S	F780	✓	104	5KCR49PN0101	EG276	✓	29
5KC46LN0153X	C176	✓	21	5KC49PN0164X	C1158	✓	24,152	5KCP49UN9838S	F781	✓	104	5KCR49PN0492S	C1314	✓	104
5KC46LN0158	CG230	✓	24,152	5KC49PN0253	C1469	✓	171	5KCP49WN9813S	P180	✓	144	5KCR49PN3011	C420	✓	25,152
5KC46LN0158X	D1113	✓	24,152	5KC49PN0281X	C806	✓	153	5KCP49ZN9617T	P190	✓	142	5KCR49PN3011X	C474	✓	25,152
5KC46LN0159	CG361	✓	27	5KC49PN0283	C1425	✓	32	5KCR39SN2504X	C1091	✓	114	5KCR49PN3012X	C486	✓	25,152
5KC46LN0159X	CG362	✓	27	5KC49PN2144Y	C1477	✓	22	5KCR39SN2557X	C1085	✓	114	5KCR49QN6076	C183	✓	21
5KC46LN0252	C1460	✓	171	5KC49PN2521Y	C704	✓	22,168	5KCR39SN2891X	C1465	✓	114	5KCR49RN2148T	C1161	✓	25,152



Index

Model Number/Catalog Number

MODEL NO.	CAT. NO.	STOCK	PAGE NO.	MODEL NO.	CAT. NO.	STOCK	PAGE NO.	MODEL NO.	CAT. NO.	STOCK	PAGE NO.	MODEL NO.	CAT. NO.	STOCK	PAGE NO.
5KCR49SN0012X	CG239	✓	25	5KH140DFK17X	H951	✓	113	5KH33KN20S	H277	✓	104	5KH37PN39X	HG113	✓	150
5KCR49SN0042S	C1302	✓	104	5KH32DN111	H208	✓	155	5KH33KN5594	H673	✓	26	5KH37PN40	H223	✓	155
5KCR49SN0065	C191	✓	22	5KH32DN3085	HG156	✓	150	5KH35FN124	H114	✓	150	5KH37PN41	H158	✓	150
5KCR49SN0068	C185	✓	22	5KH32DN3085X	H157	✓	150	5KH35FN124X	HG115	✓	150	5KH37PN41X	H159	✓	150
5KCR49SN0068X	C186	✓	22	5KH32DN5587X	4725	✓	113	5KH35FN153T	4798	✓	150	5KH37PNA233	HG695	✓	150
5KCR49SN0150X	C1160	✓	25,152	5KH32DN5597X	HG679	✓	113	5KH35GNA229	H676	✓	23	5KH37PNA479X	HG714	✓	113
5KCR49SN0493S	C1315	✓	104	5KH32DN5618X	HG701	✓	150	5KH35HN9	H229	✓	23	5KH37PNA569T	HG706	✓	151
5KCR49SN3009	C475	✓	25,152	5KH32DNA612	H901	✓	22	5KH35JN26	H166	✓	151	5KH38SNA731T	HG715	✓	151
5KCR49SN3009X	C1478	✓	25,152	5KH32DNA612X	H902	✓	22	5KH35JN26X	H167	✓	151	5KH39CN5501X	H641	✓	113
5KCR49SN3010	C476	✓	25,152	5KH32DNA700	H912	✓	150	5KH35JN121	H217	✓	155	5KH39CN5504X	H642	✓	113
5KCR49TN2139U	G1392	✓	30	5KH32DNA700X	H913	✓	150	5KH35JN121X	H218	✓	155	5KH39DNA533T	4733	✓	155
5KCR49TN2155T	C466	✓	31	5KH32EN124	H244	✓	31	5KH35JN132T	4682	✓	151	5KH39EN2506X	H440	✓	114
5KCR49TN2164T	C878	✓	115	5KH32EN5015U	4785	✓	156	5KH35JN602X	HG690	✓	25	5KH39EN2552X	H439	✓	114
5KCR49TN8058T	C1274	✓	140	5KH32EN66	H116	✓	29	5KH35JN603X	H689	✓	23	5KH39EN2887X	H685	✓	114
5KCR49UN0079U	C1294	✓	102	5KH32EN72X	H291	✓	153	5KH35JNA231	H674	✓	26	5KH39QN5508	4369	✓	26
5KCR49UN0106X	EG284	✓	32	5KH32EN79	HG178	✓	153	5KH35JNA723X	H917	✓	151	5KH39QN5508X	4310	✓	26
5KCR49UN0106Y	EG282	✓	32	5KH32ENA443X	H682	✓	113	5KH35LN164X	HG456	✓	34	5KH39QN5511X	4305	✓	150
5KCR49UN0107	EG283	✓	31	5KH32ENB168X	H454	✓	34	5KH35MN132	H197	✓	104	5KH39QN5512T	4701	✓	150
5KCR49UN0108	E285	✓	30	5KH32FN3083	H160	✓	150	5KH35MN132S	H198	✓	104	5KH39QN5514T	4706	✓	151
5KCR49WN0270	C193	✓	22	5KH32FN3083X	HG161	✓	150	5KH35MN56	B1504	✓	153	5KH39QN5520X	4314	✓	150
5KCR49WN0270T	CG381	✓	22	5KH32FN3120T	4680	✓	150	5KH35MN56X	H236	✓	153	5KH39QN5523	4359	✓	25
5KCR49WN0295U	C1295	✓	102	5KH32FN3122	H134	✓	104	5KH35MNA519T	HG703	✓	151	5KH39QN5524	4377	✓	26
5KCR49WN6075	C178	✓	21	5KH32FN3122S	H135	✓	104	5KH35MNA568T	HG704	✓	150	5KH39QN5525	4355	✓	150
5KCR49WN6077	CG232	✓	24	5KH32FN3123	HG120	✓	29	5KH36DNA780X	HG716	✓	159	5KH39QN5526X	4363	✓	150
5KCR49WN6078	C1412	✓	32	5KH32FN3123X	HG121	✓	29	5KH36JNA769	H905	✓	22	5KH39QN5528X	4381	✓	26
5KCR49ZN0564Y	C1904	✓	101	5KH32FN5586X	4406	✓	113	5KH36JNA769X	H906	✓	22	5KH39QN5529	4371	✓	26
5KCR49ZN0785S	C1909	✓	104	5KH32FN5598X	HG680	✓	113	5KH36KN112	H206	✓	155	5KH39QN5529X	4311	✓	26
5KCR49ZN2151U	9038	✓	23,168	5KH32FNA499S	X1903	✓	104	5KH36KN112X	H287	✓	155	5KH39QN5537X	4306	✓	150
5KCR49ZN8061T	C1275	✓	140	5KH32FNA611	H903	✓	22	5KH36KN113X	HG154	✓	150	5KH39QN5538X	4350	✓	150
5KE48WN4586	K2065	✓	110	5KH32FNA611X	H904	✓	22	5KH36KN114	H169	✓	150	5KH39QN5539T	4776	✓	26
5KE48WN4593	K2066	✓	109	5KH32GN42	H195	✓	104	5KH36KN114X	H170	✓	150	5KH39QN5541X	4364	✓	25
5KE48WN8364	K2056	✓	109	5KH32GN42S	HG196	✓	104	5KH36KNB633X	H344	✓	113	5KH39QN5543	4304	✓	150
5KE48WN8365	K2033	✓	53	5KH32GN140X	HG152	✓	150	5KH36LN488X	H691	✓	23	5KH39QN5548	4360	✓	150
5KE48WN8366	K2053	✓	108	5KH32GN142	H204	✓	155	5KH36LN489X	HG692	✓	26	5KH39QN5550X	4404	✓	159,166
5KE48WN8388	K2062	✓	110	5KH32GN68X	H243	✓	29	5KH36LNA504	H696	✓	23	5KH39QN5558T	4722	✓	159,166
5KE49PN4594	K2069	✓	36	5KH32GNB811X	4805	✓	113	5KH36MN137	H290	✓	155	5KH39QN9091	H230	✓	23
5KE49PN8391	K2021	✓	41	5KH32GNB812X	HG450	✓	113	5KH36MN3106	H286	✓	151	5KH39QN9105	B1502	✓	153
5KE49PN8418	K2018	✓	40	5KH32GNB813X	H451	✓	113	5KH36MN3106X	H248	✓	151	5KH39QN9105X	H234	✓	153
5KE49SN8355V	K2205	✓	79	5KH32GNB814X	HG681	✓	113	5KH36MN3127T	4684	✓	151	5KH39QN9397	4368	✓	23
5KE49TN4552	K2068	✓	109	5KH32GNB815X	H712	✓	113	5KH36MN5729X	4709	✓	151	5KH39QN9401T	4708	✓	151
5KE49TN4597	K2067	✓	110	5KH32HN5620T	HG711	✓	151	5KH36MNA445X	H684	✓	113	5KH39QN9405X	4392	✓	151
5KE49TN8356V	K2202	✓	79	5KH32HNA532T	4734	✓	155	5KH36MNA735X	H919	✓	151	5KH39QN9429T	4319	✓	150
5KE49UN8370T	K2040	✓	154	5KH32JN3128	H164	✓	151	5KH36MNB637X	H926	✓	113	5KH39QN9508Y	HG646	✓	102
5KE49QN8375T	K2038	✓	154	5KH32JN3128X	H165	✓	151	5KH36NN37	HG140	✓	104	5KH39QN9513X	4383	✓	151
5KE49UN8376T	K2037	✓	154	5KH33FN6	H239	✓	21	5KH36NN37S	HG141	✓	104	5KH39QN9514X	4309	✓	151
5KE49TN8378	K2055	✓	109	5KH33FN77	H212	✓	155	5KH36NNB166X	HG455	✓	34	5KH39QN9518X	4602	✓	26
5KE49TN8384T	K2030	✓	154	5KH33FN77X	H213	✓	155	5KH36PN106	H203	✓	104	5KH39QN9537X	4349	✓	21
5KE49TN8389	K2060	✓	110	5KH33FN85	HG123	✓	29	5KH36PN108	HG189	✓	153	5KH39QN9538	4354	✓	21
5KE49TN8390	K2058	✓	110	5KH33FN85X	HG124	✓	29	5KH36PN109	H233	✓	153	5KH39QN9541T	4338	✓	151
5KE49TN8398	K2059	✓	110	5KH33FNA230	H675	✓	25	5KH36PNB171X	HG458	✓	34	5KH39QN9542	4351	✓	23
5KE49TN8401	K2022	✓	41	5KH33FNA722X	H915	✓	150	5KH37GNA782X	HG717	✓	159	5KH39QN9543	4373	✓	23
5KE49UN8405	K2051	✓	108	5KH33GN5014U	4774	✓	156	5KH37NNA768	H907	✓	22	5KH39QN9544X	4393	✓	151
5KE49UN8407	K2023	✓	41	5KH33GNA444X	H683	✓	113	5KH37NNA768X	H908	✓	22	5KH39QN9546	4372	✓	23
5KE49UN8416	K2010	✓	37	5KH33HN5722X	4707	✓	151	5KH37PN33	H171	✓	150	5KH39QN9547	4376	✓	23
5KE49UN8428	K2043	✓	40	5KH33HN5725X	4702	✓	150	5KH37PN33X	H172	✓	150	5KH39QN9548	4322	✓	150
5KE49UN8429	K2039	✓	55	5KH33JN3121	HG138	✓	104	5KH37PN36	H209	✓	155	5KH39QN9548X	4389	✓	150
5KE49WN4571	K2045	✓	99	5KH33JN3121S	H139	✓	104	5KH37PN36X	H210	✓	155	5KH39QN9550X	4412	✓	150
5KE49WN4572	K2046	✓	99	5KH33JNA500S	X1904	✓	104	5KH37PN37	H205	✓	155	5KH39QN9551X	4399	✓	150
5KE49WN8383	K2063	✓	110	5KH33JNA511T	HG710	✓	26	5KH37PN37X	H278	✓	155	5KH39QN9631T	H131	✓	151
5KH140DFK1X	H950	✓	113	5KH33JNA534T	4735	✓	155	5KH37PN39	H112	✓	150	5KH39QN9632	H130	✓	151

Model Number/Catalog Number

MODEL NO.	CAT. NO.	STOCK	PAGE NO.	MODEL NO.	CAT. NO.	STOCK	PAGE NO.	MODEL NO.	CAT. NO.	STOCK	PAGE NO.	MODEL NO.	CAT. NO.	STOCK	PAGE NO.
5KH39QN9636T	4757	✓	151	5KH49UN6064	HG188	✓	153	48A11O1875	X039	✓	148	48A11T463	X430	✓	143
5KH39QN9639T	4778	✓	26	5KHC37NNA167T	HG700	✓	151	48A11O1876	X037	✓	148	48A11T509	X297	✓	142,165
5KH39QN9642T	H133	✓	151	5KHC39QN9575T	H649	✓	104	48A11O2001	X006	✓	147	48A11T529	X413	✓	143
5KH39QN9681X	4380	✓	23	5KHC39QN9581T	HG648	✓	104	48A11O2007	X090	✓	142	48A11T569	X412	✓	143
5KH39QN9682	4370	✓	151	5KHC39QN9584X	H647	✓	104	48A11O2009	X062	✓	149	48A11T571	X414	✓	143
5KH39QN9683	4396	✓	150	5KS46MN4078	E34D4	✓	36	48A11O2011	X064		149	48A11T578	X456	✓	143
5KH39QN9684	4387	✓	26	5KS49HN4077	E12D4	✓	36	48A11O2012	X065	✓	149	48A11T579	X457	✓	143
5KH39QN9686X	4362	✓	21	5KS49HN4595	E286	✓	108	48A11O2013	X066	✓	149	48A11T580	X458	✓	143
5KH39QN9687	4422	✓	26	5KS49MN4608	EG287	✓	108	48A11O2014	X067	✓	149	48A11T581	X459	✓	143
5KH39QN9696X	4731	✓	155	5KS49PN4602	EG307	✓	110	48A11O2015	X068		149	48A11T619	X462	✓	143
5KH39QN9697T	4759		151	5KS49UN4598	EG311	✓	110	48A11O2016	X099	✓	142	48A11T646	X072	✓	160
5KH39QN9698T	4758	✓	151	5KS49UN8379	EG297	✓	109	48A11O2017	X400	✓	142	48A11T2008	X411	✓	165
5KH39QN9702T	4732	✓	155	48A11D245	X262	✓	158	48A11O2022	X061	✓	149	48A11T2012	X415	✓	143
5KH39QN9703T	4738	✓	155	48A11O1044	X471	✓	148	48A11O2024	X070	✓	149	48A11T2013	X416	✓	143
5KH39QN9704T	4739	✓	155	48A11O1045	X472	✓	148	48A11O2026	X071	✓	149	48A11T2017	X427	✓	143
5KH39QN9725T	4730	✓	155	48A11O1046	X473	✓	148	48A11O2028	X063	✓	149	48A11T2020	X429	✓	143
5KH39QN9767X	HG694	✓	151	48A11O1047	X474	✓	148	48A11O2029	X087	✓	141	48A11T2021	X027	✓	103
5KH39QNA039	4390	✓	151	48A11O1060	X200	✓	166	48A11O2030	X080	✓	141	48A11T2022	X028	✓	103
5KH39QNB810	H645	✓	25	48A11O1062	X203	✓	162	48A11O2031	X081	✓	141	48A11T2023	X029	✓	103
5KH42GN0336	B1507	✓	153	48A11O1065	X212		166	48A11O2032	X088	✓	142	48A11T2024	X923	✓	167
5KH42GN0337	HG143	✓	104	48A11O1068	X210	✓	162	48A11O2033	X082	✓	141	48A11T2025	X924	✓	167
5KH42JN0328	H276	✓	104	48A11O1081	X215		166	48A11O2034	X083	✓	141	48A11T2026	X925	✓	167
5KH42JN0328S	H247	✓	104	48A11O1097	X216	✓	142,165	48A11O2035	X089	✓	142	48A11T11006	X076	✓	160
5KH46JN0329X	H693	✓	26	48A11O11040	X264		158	48A11O2046	X010	✓	147	48A17O69	X040	✓	149
5KH46MNN3021X	HG155	✓	150	48A11O11041	X263		158	48A11O2047	X219	✓	147	48A17O70	X041	✓	149
5KH46MNN3025	H173	✓	151	48A11O11042	X074	✓	161	48A11O2050	X223	✓	162	48A17O123	X475	✓	148
5KH46MNN3025X	H174	✓	151	48A11O11063	X075	✓	161	48A11O2051	X417	✓	147	48A17O124	X476	✓	148
5KH46MNN3040	H225	✓	155	48A11O11064	X073	✓	161	48A11O2052	X418	✓	147	48A17O125	X211	✓	147,163
5KH46MNN3041	H207	✓	155	48A11O11066	X077	✓	161	48A11O2053	X419		147	48A17O128	X477	✓	148
5KH46MNN6053	H162	✓	150	48A11O1109	X222	✓	162	48A11O2054	X424	✓	142	48A17O136	X230	✓	158,163
5KH46MNN6053X	H163	✓	150	48A11O1167	X258	✓	149	48A11O2055	X423	✓	141	48A17O147	X269	✓	158,164
5KH46MNN6071	H214	✓	155	48A11O1239	X268	✓	158,167	48A11O2059	X298	✓	142	48A17O149	X270	✓	159,166
5KH46MNN6071X	H215	✓	155	48A11O1350	X018	✓	147	48A11O2062	X441	✓	142	48A17O151	X015	✓	147
5KH46N3039T	HG705	✓	151	48A11O1351	X019	✓	147	48A11O2063	X443	✓	142	48A17O152	X013	✓	147
5KH46PN3033	HG191	✓	153	48A11O1352	X020	✓	147	48A11O2064	X442	✓	142	48A17O153	X016	✓	147
5KH46PN3034	H293	✓	153	48A11O1353	X021	✓	147	48A11O2065	X440	✓	142	48A17O154	X014	✓	147
5KH46PN6059	HG186	✓	153	48A11O1375	X426	✓	142,158	48A11O251	X260	✓	163	48A17O155	X017	✓	147
5KH48UN6054X	H298	✓	151	48A11O1410	X295		167	48A11O653	X042	✓	149	48A17O161	X273		162
5KH48UN6074	H221	✓	155	48A11O1461	X431	✓	145	48A11O654	X043	✓	149	48A17O169	X420	✓	141
5KH49MN3035	H190	✓	153	48A11O1524	X213	✓	141	48A11O655	X044	✓	149	48A17O172	X422	✓	142
5KH49MN6057	H136	✓	104	48A11O1525	X214	✓	142	48A11O656	X045	✓	149	48A17O174	X022	✓	147
5KH49MN6057S	H137	✓	104	48A11O1526	X221	✓	142	48A11O678	X085	✓	142	48A17O250	X454	✓	142
5KH49MN6060	HG182	✓	153	48A11O1583	X023	✓	147	48A11O694	X237		147,162	48A17O2001	X058	✓	149
5KH49PN3026	H175	✓	151	48A11O1596	X444	✓	142	48A11O697	X241	✓	147,162	48A17O2002	X059		149
5KH49PN3026X	H176	✓	151	48A11O1642	X447	✓	144	48A11O699	X236	✓	147,162,165	48A17O2003	X060		149
5KH49PN3042	H226	✓	155	48A11O1643	X446	✓	144	48A11O756	X242	✓	147,162	48A17O2004	X069		149
5KH49PN3042X	H282	✓	155	48A11O1674	X033	✓	147,165	48A11O772	X048		149	48A17O2005	X011	✓	141,147
5KH49PN3043	H620	✓	150	48A11O1732	X445		144	48A11O773	X049	✓	149	48A17O2006	X012	✓	141,147
5KH49PN3045	H275	✓	151	48A11O1744	X405	✓	162	48A11O774	X050	✓	149	48A17T72	X301	✓	159
5KH49PN3047	H222	✓	155	48A11O1755	X004	✓	147	48A11O775	X052	✓	149	48A17T86	X466	✓	143
5KH49PN6055	H168	✓	151	48A11O1756	X005	✓	147	48A11O787	X009	✓	147	48A17T87	X467	✓	143
5KH49PN6055X	HG621	✓	151	48A11O1769	X002	✓	147	48A11O840	X096	✓	142	48A17T96	X468	✓	143
5KH49PN6056	HG142	✓	104	48A11O1770	X455	✓	142	48A11O885	X470	✓	165	48A17T118	X030	✓	103
5KH49PN6056S	HG699	✓	104	48A11O1771	X453	✓	142	48A11O900	X057		149	48A17T119	X032	✓	103
5KH49PN6069	H219	✓	155	48A11O1772	X036	✓	148	48A11O901	X056	✓	149	48A17T237	X031	✓	103
5KH49SN3023X	H288	✓	155	48A11O1773	X034	✓	148	48A11O2042	X003	✓	147	48A17T356	X463	✓	143
5KH49SN3046	H296	✓	150	48A11O1774	X035	✓	148	48A11T198	X303	✓	159	48A17T359	X464	✓	143
5KH49SN3048	H300	✓	150	48A11O1798	X000	✓	147	48A11T199	X302	✓	159	48A17T2001	X305	✓	159
5KH49SN3049	H224	✓	155	48A11O1799	X001	✓	147	48A11T201	X304	✓	159	48A17T2002	X024	✓	103
5KH49UN3024X	H280	✓	155	48A11O1874	X038	✓	148	48A11T276	X469	✓	143	48A17T2003	X025	✓	103



Index

Model Number/Catalog Number

MODEL NO.	CAT. NO.	STOCK	PAGE NO.	MODEL NO.	CAT. NO.	STOCK	PAGE NO.	MODEL NO.	CAT. NO.	STOCK	PAGE NO.	MODEL NO.	CAT. NO.	STOCK	PAGE NO.
48A17T2004	X026	✓	103	48S17D2108	B207	✓	151	56B17F5328	T018	✓	176	56C17D2084	G212	✓	27
48A17T2005	X920	✓	167	48S17D2109	B208	✓	151	56B17F5329	T030	✓	176	56C17D2085	G230	✓	27
48A17T2006	X921	✓	167	48S17D2113	S026		23	56B17F5330	D404	✓	99	56C17D2088	G135	✓	24,152
48A17T2007	X922	✓	167	48S17D2116	B606	✓	150	56B17F5331	F205	✓	102	56C17D2097	S112	✓	26
48A34SU1001	O701	✓	156	48S17D2117	B607	✓	151	56B17F5584	F135	✓	32,101	56C17D2098	S012	✓	23
48A8O151	X261	✓	163	48S17D7204	D180		150	56B17F15516	F1205	✓	102	56C17D2099	S113	✓	26
48A8O181	X098	✓	142	48S17D7205	D181		151	56B17T20	X913	✓	103	56C17D2101	X601	✓	164
48A8O182	X097	✓	141	48S17D7209	B402	✓	140	56B17T5303	X912	✓	103	56C17D2102	X602	✓	164
48A8O183	X209	✓	147,165	48S17S24	O003	✓	156	56B34D2018	K212		174	56C17D2113	B608	✓	152
48A8O206	X278	✓	142,165	48S17S25	O002	✓	156	56B34D2021	G987		174	56C17D2114	K234		28
48A8O2001	X086	✓	142	48S17T286	O600	✓	156	56B34D2023	G258		27	56C17D2115	K235	✓	28
48A8T71	X450	✓	143	48S17T290	O601	✓	156	56B34D2026	G937	✓	22	56C17D5308	G951	✓	22,168
48A8T72	X451	✓	143	48S17T365	X911	✓	106	56B34D2027	D115	✓	25,152	56C17D5310	G256	✓	27
48A8T73	X452	✓	143	48S17T366	X910	✓	106	56B34D2028	O231	✓	157	56C17D5311	G270	✓	27
48A8T11002	X465	✓	143	48S17T2004	X909	✓	106	56B34D2029	D010	✓	21,168,174	56C17D5319	S037	✓	23
48C17D2023	S010	✓	23	48S34S361	O100	✓	156	56B34D2031	G254	✓	27	56C17D5320	S039	✓	23
48C17D2024	S011	✓	23	48S34S2003	O004	✓	156	56B34D2033	J058	✓	115	56C17D5339	S116	✓	26
48C17D2027	S030	✓	23	48S34S2004	O005	✓	156	56B34D5302	D017		22,168	56C17D5340	S117	✓	26
48C17D2028	S110	✓	26	48S34S2005	O102	✓	156	56B34D5304	G976		174	56C17D5343	S038	✓	23
48C17D2029	S111	✓	26	48T17D2000	G044	✓	36	56B34D5307	G294		174	56C17D5346	X603	✓	164
48C17D2034	G078	✓	21	52A101229AAG1	A549	✓	199	56B34D5319	G272	✓	27	56C17D5347	B336	✓	25,152
48C17D2041	B312	✓	152	52A103486G1	A964	✓	200	56B34D5320	K152	✓	25,152	56C17D5348	B337	✓	152
48C17D2042	B313	✓	152	52D310814AAP1	A942	✓	200	56B34D5334	G996		174	56C17D5349	B338	✓	152
48C17D2043	B314	✓	152	52D310822ACP1	A962	✓	200	56B34D5336	K219		174	56C17E5302	K032		34
48C17D2044	B315	✓	152	52D310833AAP001	A940	✓	200	56B34D5337	O232		157	56C17E5314	G639	✓	34
48C17D2045	S118	✓	25	52D311808ARP1	A941	✓	200	56B34D5341	J059	✓	115	56C17E5319	G852	✓	35
48C17D2046	S119	✓	25	52D311819ABP1	A963	✓	200	56B34F5303	K332		175	56C17F15537	F1204	✓	102
48C17D2055	D119	✓	152	56A11O29	X432	✓	143	56B34F5306	K612	✓	175	56C17F2049	G332	✓	29
48C17D2057	X600		164	56A11O30	X433	✓	143	56B34F5312	K615	✓	175	56C17F2051	G339	✓	29
48C17F11005	F1201	✓	102	56A11O5305	X271	✓	144	56B34F5318	K618	✓	175	56C17F2052	G314	✓	29
48C17F11006	F1202	✓	102	56A11O5310	X206	✓	144	56B34F5319	G533	✓	31	56C17F5308	G356	✓	29
48C17F11007	F1203	✓	102	56A11O5311	X207	✓	144	56B34F5320	G374	✓	30	56C17F5311	G373	✓	30,175
48C34D2024	O010	✓	156	56A11O5313	X218	✓	166	56B34F5321	G391	✓	30	56C17F5320	G570	✓	33
48C34D2025	G091		21	56A11O5314	X448	✓	144	56B34F5322	K350		30	56C17F5321	G571	✓	33
48C34D2028	O011	✓	156	56A11O5315	X449		144	56B34F5324	K631		32	56C17F5322	G572	✓	33
48C34S24	O012	✓	156	56A805	X208	✓	142	56B34F5326	D314	✓	33	56C17F5323	G573	✓	33
48C34S2001	O013		156	56B17D2012	G156	✓	24,152	56B34F5327	D315	✓	33	56C17F5324	F101	✓	101
48N17D14	B703	✓	151	56B11F5302	G579	✓	33	56B34F5328	D316	✓	33	56C17F5325	F102	✓	101
48S17D997	B400	✓	140	56B11F5303	G578	✓	33	56B34F5332	T017	✓	176	56C17F5326	F103	✓	101
48S17D2017	D107	✓	150	56B11G5301	G655	✓	34	56B34F5333	T019	✓	176	56C17F5327	F104	✓	101
48S17D2042	S102	✓	25	56B17D56	K016	✓	168,174	56C11D5304	G278	✓	27,155	56C17F5349	T016	✓	176
48S17D2052	B300	✓	150	56B17D67	B353	✓	152	56C11F5302	G577	✓	33	56C17F5350	T014	✓	176
48S17D2053	B322	✓	150	56B17D2010	G919	✓	21	56C11F5303	G576	✓	33	56C17F5351	T010	✓	176
48S17D2054	B302	✓	150	56B17D2011	G250	✓	27	56C11G5303	K033	✓	34	56C17F5352	D400	✓	99
48S17D2055	B303	✓	150	56B17D2013	B609	✓	152	56C11G5306	G650	✓	34	56C17F5353	D401	✓	99
48S17D2056	B304	✓	151	56B17D5303	G274	✓	27	56C11G5307	G652	✓	34	56C17F5354	D402	✓	99
48S17D2057	B305	✓	151	56B17D5319	G979		174	56C17D2010	G095	✓	21	56C17F5355	D403	✓	99
48S17D2058	B306	✓	151	56B17D5322	K232	✓	174	56C17D2025	G151	✓	24,152	56C17F5357	F204	✓	102
48S17D2059	B307	✓	151	56B17D5323	G958	✓	174	56C17D2044	G234	✓	27	56C17F5358	F131	✓	32,101
48S17D2086	D143	✓	151	56B17D5328	G290		174	56C17D2051	S013	✓	23	56C17F5912	F132	✓	32,101
48S17D2087	D162	✓	151	56B17D5331	B352	✓	25,152	56C17D2054	S014	✓	23	56C17F5913	F133	✓	32,101
48S17D2088	D163	✓	151	56B17D5701	B332		152	56C17D2055	S015	✓	23	56C17F5914	F134	✓	32,101
48S17D2089	S003	✓	23	56B17D5703	B335	✓	152	56C17D2060	S114	✓	26	56C17F5955	G381	✓	175
48S17D2090	S006	✓	23	56B17F5302	G378	✓	30,175	56C17D2061	S115	✓	26	56C17F5956	G382	✓	175
48S17D2091	S103		25	56B17F5305	G574	✓	33	56C17D2064	S033	✓	23	56C17F5957	G380		175
48S17D2093	S106	✓	26	56B17F5306	G575	✓	33	56C17D2067	S036	✓	23	56C17G5308	K037		34
48S17D2104	S126	✓	25	56B17F5307	F105	✓	101	56C17D2072	B317	✓	24,152	56C17G5315	G651	✓	34
48S17D2105	S127	✓	26	56B17F5310	G396	✓	175	56C17D2073	B318	✓	24,152	56C17G5316	G654	✓	34
48S17D2106	S128	✓	26	56B17F5319	K319	✓	32,101,175	56C17D2074	B319	✓	24,152	56C17G5317	G657	✓	34
48S17D2107	B206	✓	150	56B17F5324	X902		103	56C17D2079	D111	✓	24,152	56C17G5318	G659	✓	34

Model Number/Catalog Number

MODEL NO.	CAT. NO.	STOCK	PAGE NO.	MODEL NO.	CAT. NO.	STOCK	PAGE NO.	MODEL NO.	CAT. NO.	STOCK	PAGE NO.	MODEL NO.	CAT. NO.	STOCK	PAGE NO.
56C17G5320	G853	✓	35	56C34W5308	N540	✓	107	56H17T2021	Y605		87	56T17D2101	G100	✓	154
56C17G5321	G855	✓	35	56C34W5309	N542	✓	107	56H17T2022	Y606	✓	87	56T17D2104	G106	✓	154
56C17G5322	G857	✓	35	56C34W5310	N544	✓	107	56H17T5301	Y534	✓	89	56T17D2110	G086	✓	36
56C17G5323	G870	✓	35	56E17F1001	Z602	✓	94	56H17T5302	Y535	✓	89	56T17D2111	G082	✓	36
56C17G5324	G871	✓	35	56E17F1002	Z603	✓	94	56H17T5311	Y555	✓	89	56T17D2112	G065	✓	36
56C17G5326	G874	✓	35	56E17F1003	Z604	✓	94	56H17T5312	Y556	✓	89	56T17D2113	K003	✓	36
56C17G5327	G876	✓	35	56E17F1004	Z605	✓	94	56H17T15526	Y280	✓	88	56T17D2114	G062	✓	36
56C17G5328	G872	✓	35	56E17F1005	Z606	✓	94	56H17T15527	Y282	✓	88	56T17D2115	G242	✓	40
56C17W5326	N531	✓	107	56E17F1006	Z607	✓	94	56H17T15528	Y281	✓	88	56T17D2116	G243	✓	40
56C17W5327	N523	✓	107	56E17F1007	Z610	✓	94	56S17D2023	S120	✓	26	56T17D2117	G964		154
56C17W5328	N525	✓	107	56E17F1008	Z611	✓	94	56S17D2046	S022	✓	23	56T17D2118	G961	✓	154
56C17W5329	N527	✓	107	56E17F2005	Z612	✓	94	56S17D2047	B201	✓	150	56T17D2119	G962	✓	154
56C17W5330	N529	✓	107	56E17F2006	Z613	✓	94	56S17D2048	B202	✓	151	56T17D2120	G963	✓	154
56C17W5331	N557	✓	107	56E17F2007	Z614	✓	94	56S17D2049	B200	✓	151	56T17D2121	G162	✓	154
56C17W5332	N559	✓	107	56E17F2008	Z666	✓	95	56S17D2050	D149	✓	151	56T17D2127	G244		40
56C17W5333	N541	✓	107	56E17F2009	Z667	✓	95	56S17D2062	B401	✓	140	56T17D2128	G046		36
56C17W5334	N543	✓	107	56E17F2010	Z668	✓	95	56S17D2064	B100	✓	151	56T17D2130	K049	✓	37
56C17W5335	N545		107	56E17F2011	Z669	✓	95	56S17D2066	S027		23	56T17D3301	K063	✓	36
56C34D2098	O212	✓	157	56E17T2001	Z660	✓	95	56S17F5303	B506		153	56T17D3302	K064	✓	37
56C34D2099	O213	✓	157	56E17T2002	Z662	✓	95	56S34D93	O201	✓	157	56T17D3303	K065	✓	37
56C34D2100	G915	✓	21	56E17T2003	Z663	✓	95	56S34D2000	O200	✓	157	56T17D3304	K066	✓	38
56C34D2101	G238	✓	27	56E17T2004	Z664	✓	95	56T11D5209	X235	✓	163	56T17D3305	K067		36
56C34D2104	O214	✓	157	56E17T2005	Z665	✓	95	56T11D5301	G061		36	56T17D3306	K068	✓	37
56C34D2105	O217	✓	157	56E17V2001	Z630	✓	95	56T11D5302	G067	✓	36	56T17D3307	K069	✓	37
56C34D2106	D118	✓	24,152	56E17V2002	Z631		95	56T11D5303	G088	✓	36	56T17D3308	K080	✓	38
56C34D2108	G232	✓	27	56E17V2003	Z634	✓	95	56T11D5304	K007	✓	37	56T17D5309	K022	✓	37
56C34D2109	O211	✓	157	56E17V2004	Z635	✓	95	56T11F5307	K701	✓	55	56T17D5310	K041	✓	37
56C34D2112	O215	✓	157	56E17V2005	Z636	✓	95	56T11F5308	G589	✓	55	56T17D5329	G122	✓	154
56C34D2114	O210	✓	157	56E17V2006	Z637		95	56T11F5309	G588	✓	55	56T17D5332	G127	✓	154
56C34D2117	G216	✓	27	56E17W2001	Z638	✓	95	56T11F5310	G587	✓	55	56T17D5336	G905	✓	36
56C34D2118	J054	✓	115	56E17W2002	Z639	✓	95	56T11F5311	G586	✓	55	56T17D5339	G908	✓	36
56C34D2119	J055	✓	115	56E17W2003	Z641		95	56T11F5320	K404		53	56T17D5342	G921	✓	36
56C34D2120	J056	✓	115	56H17E5301	Y600	✓	90	56T11F5321	K407		53	56T17D5344	G923	✓	37
56C34D2121	J057	✓	115	56H17E5302	Y601	✓	90	56T11F5325	D451	✓	100	56T17D5345	G140	✓	154
56C34F5301	D311	✓	33	56H17E5303	Y602	✓	90	56T11F5326	D453	✓	100	56T17D5346	G141	✓	154
56C34F5302	D312	✓	33	56H17E5304	Y603	✓	90	56T11F5327	D455	✓	100	56T17D5347	G142	✓	154
56C34F5303	D313	✓	33	56H17E5305	Y604	✓	90	56T11F5328	K700	✓	56	56T17D5348	G143	✓	154
56C34F5307	G393	✓	29	56H17F2011	Y506	✓	87	56T11O15	X259	✓	164	56T17D5349	G144	✓	154
56C34F5308	G352	✓	29	56H17F2012	Y507		87	56T11O5300	X500	✓	146	56T17D5350	G145	✓	154
56C34F5309	G379	✓	29,175	56H17F2013	Y508		87	56T11O5301	X501	✓	146	56T17D5357	G965		154
56C34F5310	G359	✓	30	56H17F2014	Y521		87	56T11O5302	X502	✓	146	56T17D5369	K061	✓	37
56C34F5311	G390	✓	30,175	56H17F2015	Y363		87	56T11O5303	X503	✓	146	56T17D5370	K062	✓	37
56C34F5322	G514		31	56H17F2016	Y377		87	56T11O5304	X509	✓	146	56T17D5385	G967		154
56C34F5323	G516	✓	31	56H17F2017	Y362	✓	87	56T11O5305	X513	✓	145	56T17D5398	H803	✓	38
56C34F5324	G518	✓	31	56H17F2018	Y376	✓	87	56T11O5306	X523	✓	145,158	56T17D5701	G161		154
56C34F5327	K339		29	56H17F2019	Y365	✓	87	56T11O5307	X524	✓	146	56T17D15528	K081		37
56C34F5339	T015	✓	176	56H17F2020	Y379	✓	87	56T11O5308	X522	✓	146	56T17E5308	G646	✓	79
56C34F5340	T013	✓	176	56H17F2021	Y364	✓	87	56T11O5309	X526	✓	146	56T17E5309	G647	✓	79
56C34G5308	G653	✓	34	56H17F2022	Y378	✓	87	56T11O5310	X525	✓	145,158	56T17E5310	G827	✓	80
56C34G5309	G656		34	56H17T2001	Y592	✓	89	56T11O11001	X532	✓	145	56T17E5311	G828	✓	80
56C34G5310	G658		34	56H17T2011	Y500	✓	87	56T11O11002	X533	✓	145	56T17E5312	G842		80
56C34G5311	G854		35	56H17T2012	Y501	✓	87	56T11O15511	X512		145	56T17E5313	G843	✓	80
56C34G5314	G873	✓	35	56H17T2013	Y502	✓	87	56T11V5376	N568	✓	110	56T17E5314	G664		79
56C34G5315	G875		35	56H17T2014	Y503	✓	87	56T11V5377	N600		110	56T17E5315	G665		79
56C34G5316	G858		35	56H17T2015	Y504	✓	87	56T11W5377	N604	✓	110	56T17F2043	G304	✓	47
56C34W5302	N532	✓	107	56H17T2016	Y505		87	56T11W5378	N608	✓	110	56T17F2045	G328		47
56C34W5303	N524		107	56H17T2017	Y360	✓	87	56T17D2092	K004	✓	36	56T17F2047	K405		53
56C34W5304	N526		107	56H17T2018	Y374	✓	87	56T17D2093	G084	✓	36	56T17F2051	G565		55
56C34W5305	N528		107	56H17T2019	Y361		87	56T17D2094	G063	✓	36	56T17F5302	G347	✓	47
56C34W5307	N558	✓	107	56H17T2020	Y375		87	56T17D2095	G047	✓	36	56T17F5320	G548		53



Index

Model Number/Catalog Number

MODEL NO.	CAT. NO.	STOCK	PAGE NO.	MODEL NO.	CAT. NO.	STOCK	PAGE NO.	MODEL NO.	CAT. NO.	STOCK	PAGE NO.	MODEL NO.	CAT. NO.	STOCK	PAGE NO.
56T17F5321	G581	✓	55	56T17W5334	N628	✓	110	56T34F5352	K723	✓	56	71T34FH5302	R309	✓	96
56T17F5322	G582	✓	55	56T17W5335	N621		110	56T34F5353	K725	✓	56	71T34FH5304	R409	✓	96
56T17F5323	G583	✓	55	56T17W5339	N623		110	56T34F5940	E2000	✓	62	71T34FH5407	R366	✓	98
56T17F5324	G584	✓	56	56T17W5340	N320	✓	108	56T34F15940	E2100	✓	58	71T34FH5410	R369	✓	98
56T17F5325	G585	✓	56	56T17W5341	N627	✓	110	56T34F16001	E2150		58	71T34FH5507	R386	✓	98
56T17F5327	G387		48	56T17W5344	N322		108	56T34F16020	E2125		58	71T34FH5510	R389	✓	98
56T17F5329	G549		53	56T17WD5326	N413	✓	111	56T34G5303	G648		79	80T11FH5376	R305	✓	96
56T17F5330	K806		56	56T17WD5328	N417	✓	111	56T34G5304	G660		79	80T11FH5377	R308	✓	96
56T17F5336	K705	✓	55	56T17WD5329	N415	✓	111	56T34G5305	G662		79	80T11FH5378	R311	✓	96
56T17F5337	K707	✓	55	56T17WD5330	N433	✓	111	56T34T5303	D390	✓	55	80T11FH5406	R365	✓	98
56T17F5338	K709	✓	55	56T17WD5331	N435	✓	111	56T34T5306	P101	✓	53,117	80T11FH5409	R368	✓	98
56T17F5339	K722	✓	56	56T17WD5332	N437	✓	111	56T34T5308	J060		117	80T11FH5412	R371	✓	98
56T17F5340	K724	✓	56	56T34D5300	K027		36	56T34T5309	K702		55	80T11FH5506	R385	✓	98
56T17F5348	D450	✓	100	56T34D5301	G080	✓	36	56T34V5301	N643	✓	109	80T11FH5509	R388	✓	98
56T17F5349	D452	✓	100	56T34D5302	K000	✓	36	56T34V5302	N645	✓	109	80T11FH5512	R391	✓	98
56T17F5350	D454	✓	100	56T34D5303	K009	✓	37	56T34V5303	N648		109	80T17FH5326	R310	✓	96
56T17F5355	G590	✓	56	56T34D5304	K025	✓	37	56T34V5304	N651	✓	109	80T17FH5327	R313	✓	96
56T17F5356	G591		56	56T34D5327	G205		40	56T34V5305	N566	✓	110	80T17FH5330	R410	✓	96
56T17F5357	D456	✓	100	56T34D5339	G289		40	56T34V5306	N569	✓	110	80T17FH5331	R413	✓	96
56T17F5358	D457	✓	100	56T34D5340	K048		37	56T34V5307	N601	✓	110	80T17FH5411	R370	✓	98
56T17G5312	G649	✓	79	56T34D5357	B193	✓	154	56T34V5308	N605	✓	110	80T17FH5414	R373	✓	98
56T17G5313	G661	✓	79	56T34D5364	X251	✓	154,163	56T34V5309	N609	✓	110	80T17FH5511	R390	✓	98
56T17G5314	G663	✓	79	56T34D5365	J049	✓	116	56T34VD5301	N450	✓	111	80T17FH5514	R393	✓	98
56T17G5315	G829	✓	80	56T34D5366	J050	✓	116	56T34VD5302	N451	✓	111	80T34FH5301	R312	✓	96
56T17G5316	G840	✓	80	56T34D5367	J048	✓	116	56T34VD5303	N452	✓	111	80T34FH5302	R315	✓	96
56T17G5317	G841	✓	80	56T34D5368	J047		116	56T34WD5301	N453		111	80T34FH5303	R415	✓	96
56T17G5318	G844		80	56T34D5369	J051	✓	116	56T34WD5302	N455	✓	111	80T34FH5305	R412	✓	96
56T17G5319	G845	✓	80	56T34D5370	J052	✓	116	56T34WD5303	N457	✓	111	80T34FH5413	R372	✓	98
56T17G5320	G846		80	56T34D5371	J053	✓	116	56T8O5301	X506		146	80T34FH5416	R375	✓	98
56T17G5321	G666	✓	79	56T34D6001	U244	✓	42	56T8O5302	X507	✓	146,158	80T34FH5513	R392	✓	98
56T17G5322	G667	✓	79	56T34F5301	D391	✓	55	56T8O5303	X511	✓	146	80T34FH5516	R395	✓	98
56T17G5323	G668	✓	79	56T34F5302	D392	✓	55	56T8O5304	X527	✓	146	90LT17FH6326	R319A	✓	96
56T17T5305	G580	✓	55	56T34F5303	D393	✓	55	56T8O5306	X528	✓	145,158	90LT17FH6327	R419A	✓	96
56T17T5316	K703	✓	55	56T34F5304	D394	✓	56	56T8O5307	X530	✓	146	90LT17FH6419	R378A	✓	98
56T17V5326	N640	✓	109	56T34F5305	D395	✓	56	56T8O5531	X529	✓	145,158	90LT17FH6519	R398A	✓	98
56T17V5327	N641	✓	109	56T34F5306	D396	✓	56	56T8O15504	X531	✓	145,158	90LT34FH6301	R321A	✓	97
56T17V5328	N642	✓	109	56T34F5308	G569		55	63T17FH5326	R301	✓	96	90LT34FH6302	R421A	✓	97
56T17V5329	N644	✓	109	56T34F5321	P102	✓	53,117	63T17FH5327	R401	✓	96	90LT34FH6420	R379A	✓	98
56T17V5330	N646	✓	109	56T34F5322	P103	✓	53,117	63T17FH5402	R361	✓	98	90LT34FH6520	R399A	✓	98
56T17V5331	N649	✓	109	56T34F5323	P104	✓	53,117	63T17FH5502	R381	✓	98	90ST11FH6376	R314A	✓	96
56T17V5332	N564	✓	110	56T34F5324	P105	✓	53,117	63T34FH5301	R300	✓	96	90ST11FH6415	R374A	✓	98
56T17V5336	N567	✓	110	56T34F5325	P106	✓	53,117	63T34FH5302	R303	✓	96	90ST11FH6515	R394A	✓	98
56T17V5337	N622	✓	110	56T34F5326	P107	✓	54,117	63T34FH5303	R400	✓	96	90ST17FH6326	R316A	✓	96
56T17V5338	N599	✓	110	56T34F5328	G308	✓	47	63T34FH5304	R403	✓	96	90ST17FH6327	R416A	✓	96
56T17V5340	N602	✓	110	56T34F5333	G309	✓	47	63T34FH5401	R360	✓	98	90ST17FH6417	R376A	✓	98
56T17V5342	N606	✓	110	56T34F5334	G327	✓	47	63T34FH5404	R363	✓	98	90ST17FH6517	R396A	✓	98
56T17V5346	N309	✓	108	56T34F5335	G345		47	63T34FH5501	R380	✓	98	90ST34FH6301	R318A	✓	96
56T17V5347	N400		112	56T34F5336	G363		48	63T34FH5504	R383	✓	98	90ST34FH6302	R418A	✓	96
56T17V5348	N401	✓	112	56T34F5337	G368		48	71T11FH5376	R302	✓	96	90ST34FH6418	R377A	✓	98
56T17V5349	N402		112	56T34F5338	G385		48	71T11FH5403	R362	✓	98	90ST34FH6518	R397A	✓	98
56T17V15501	N620A	✓	110	56T34F5342	J061	✓	117	71T11FH5503	R382	✓	98	100LTC6501	R351A	✓	97
56T17VD5326	N410	✓	111	56T34F5343	J062	✓	117	71T17FH5326	R304	✓	96	100LTC6502	R451A	✓	97
56T17VD5327	N412	✓	111	56T34F5344	J063	✓	117	71T17FH5327	R307	✓	96	100LTC6526	R322A	✓	97
56T17VD5328	N411	✓	111	56T34F5345	J064	✓	117	71T17FH5330	R404	✓	96	100LTC6527	R422A	✓	97
56T17VD5329	N430	✓	111	56T34F5346	J065	✓	117	71T17FH5331	R407	✓	96	100LTC6536	R352A	✓	97
56T17VD5330	N431	✓	111	56T34F5347	J066	✓	117	71T17FH5405	R364	✓	98	100LTC6537	R452A	✓	97
56T17VD5331	N432	✓	111	56T34F5348	K704	✓	55	71T17FH5408	R367	✓	98	100LTC6576	R320A	✓	96
56T17W5326	N653	✓	109	56T34F5349	K706	✓	55	71T17FH5505	R384	✓	98	100LTC6586	R317	✓	96
56T17W5327	N611	✓	110	56T34F5350	K708	✓	55	71T17FH5508	R387	✓	98	111A271P111	A961	✓	200
56T17W5328	N313		108	56T34F5351	K721	✓	56	71T34FH5301	R306	✓	96	111A271P113	A965	✓	197

Model Number/Catalog Number

MODEL NO.	CAT. NO.	STOCK	PAGE NO.	MODEL NO.	CAT. NO.	STOCK	PAGE NO.	MODEL NO.	CAT. NO.	STOCK	PAGE NO.	MODEL NO.	CAT. NO.	STOCK	PAGE NO.
112A515AKG4	AG228	✓	198	143TTDR4049	U127		127	143TTFR6010	GT1203	✓	66	145TBFR5309	T031	✓	176
112A515ASG2	AG229	✓	198	143TTDR4051	U418	✓	37	143TTFR6032	GT1201	✓	66	145TBFR5327	I201	✓	30
112MTFC6511	R324A	✓	97	143TTDR4052	U417	✓	36	143TTFR15582	E2103	✓	58	145TBFR5328	Z118	✓	101
112MTFC6512	R424A	✓	97	143TTDR4055	U922		37	143TTFR15642	E2101	✓	58	145TBFR5333	I311		175
112MTFC6536	R325A	✓	97	143TTDR4061	U416		36	143TTFR16001	E2153		58	145TBFR5334	I700	✓	30
112MTFC6537	R425A	✓	97	143TTDR5309	M303	✓	119	143TTFR16003	GT1403	✓	66	145TBFR5336	I702		175
112MTFC6576	R323A	✓	97	143TTDR5313	E783	✓	37	143TTFR16020	E2128		58	145TBFR5337	C281		32
113A617AG001	A948	✓	200	143TTDR5327	H601	✓	36	143TTFR16038	E2151	✓	58	145TBFR5341	Z128	✓	101
113A620AYP1	A949	✓	200	143TTDR5334	M302	✓	119	143TTFR16039	GT1401	✓	66	145TCDR5328	Z403		118
115D963P1	A947	✓	200	143TTDR5336	M301	✓	119	143TTFR16040	E2126	✓	58	145TCDR5329	Z422		126
115D964P1	A945	✓	200	143TTDR5347	E715	✓	36	143TTGN4020	C301A		80	145TCDR5331	I146	✓	25,152
115D964P2	A946	✓	200	143TTDR5348	E901	✓	36	143TTGN4030	U020	✓	81	145TEFR5326	Z615	✓	94
132MTFC6536	R331A	✓	97	143TTDR5351	E912	✓	37	143TTGN4062	C320A	✓	80	145TEFR5327	Z616	✓	94
132MTFC6537	R431A	✓	97	143TTDR5376	H150	✓	36	143TTGN6501	U058A	✓	82	145THEN8034	Y979	✓	92
132MTFC6586	R326A	✓	97	143TTDR5401	H180		36	143TTGN6526	U001A	✓	82	145THFR5326	Y523		87
132MTFC6587	R329A	✓	97	143TTDR6007	GT0403	✓	123	143TTGN6530	U020A	✓	82	145THFR5329	Y368	✓	87
132STFC6501	R327A	✓	97	143TTDR6008	GT0503	✓	123	143TTGN6532	U986A		82	145THFR5330	Y369	✓	87
132STFC6502	R330A	✓	97	143TTDR6027	U758	✓	42	143TTGN7076	H350	✓	82	145HTN6046	Y551	✓	89
132STFC6503	R427A	✓	97	143TTDR6028	U245	✓	42	143TTGR16001	I506	✓	79	145HTN6060	Y557	✓	89
132STFC6504	R430A	✓	97	143TTDR6030	GT0401	✓	123	143TTGR16005	I507	✓	79	145HTN8029	Y526	✓	91
132STFC6526	R328A	✓	97	143TTDR6031	GT0501	✓	123	143TTGR16026	I502	✓	79	145HTN8037	Y590	✓	91
132STFC6527	R428A	✓	97	143TTDR6051	U418A	✓	37	143TTGR16030	I503		79	145HTN8043	Y987	✓	93
132STFC6586	R353A	✓	97	143TTDR6052	U417A	✓	37	143TTTC4026	E826	✓	50	145HTN9001	W511		74
143TBFR5301	I220	✓	30	143TTDR6313	E783A	✓	37	143TTTN4001	E833	✓	50	145HTN9026	W507	✓	74
143TBFR5376	I707		29	143TTDR14003	U129A	✓	127	143TTTN4003	E831		50	145HTN9027	W513	✓	74
143TCDR5303	I101		22	143TTDR14004	E095		119	143TTTN4005	E835		50	145HTN9076	W503		74
143TCDR5328	Z401		118	143TTDR14048	U123A		127	143TTTN4028	E825		50	145HTN17034	Y285	✓	88
143TCDR5330	Z420		126	143TTDR14049	K634A	✓	40	143TTTN4030	E828	✓	50	145HTN19002	W512		74
143TCFR5328	Z123	✓	101	143TTDR16005	E798A	✓	42	143TTTN6001	E351	✓	58	145HTN19033	W514		74
143THEN8034	Y978		92	143TTDR16006	GT2503	✓	131	143TTTN6501	E651	✓	69	145HTN19045	W508		74
143HTN8028	Y525	✓	91	143TTDR16015	GT2403	✓	131	143TTTN6502	E463		69	145HTN19079	W638		74
143HTN8036	Y986	✓	93	143TTDR16036	U922A		36	143TTTN6505	E851		69	145HTR5326	Y538	✓	89
143HTN9001	W505		74	143TTDR16037	E912A	✓	42	143TTTN6526	E649	✓	69	145HTR5328	Y522	✓	87
143HTN9005	W506		74	143TTDR16040	GT2501	✓	131	143TTTN6530	E666	✓	69	145HTR5329	Y366	✓	87
143HTN9026	W501	✓	74	143TTDR16048	GT2401	✓	131	143TTTN6563	E461	✓	69	145HTR5330	Y367		87
143HTN19033	W502		74	143TTFN6501	E377		69	143TTTN6576	E648	✓	69	145HTR5376	Y537	✓	89
143HTR5326	Y536	✓	89	143TTFN6502	E378		69	143TTVD5326	N403	✓	112	145HTR15540	Y284	✓	88
143HTR15535	Y283	✓	88	143TTFN6505	E379		69	143TTVR5326	N647	✓	109	145TTDR4003	E919		37
143TTDR4005	E917		37	143TTFN6526	E374		69	143TTVR5327	N650	✓	109	145TTDR4005	U906		37
143TTDR4006	E798		37	143TTFN6563	E375		69	143TTVR5329	N310	✓	108	145TTDR4010	E133		119
143TTDR4009	E123		119	143TTFN6576	E373		69	143TTWD4002	N456	✓	111	145TTDR4011	U141		127
143TTDR4011	U132		127	143TTFN8076	H457	✓	50	143TTWD4026	N414	✓	111	145TTDR4012	U144		127
143TTDR4016	E120		119	143TTFN16539	E376		69	143TTWD4527	N434A	✓	111	145TTDR4015	E130		119
143TTDR4017	E122		119	143TTFR4003	E830		48	145TTWD4528	N438A	✓	111	145TTDR4016	E132		119
143TTDR4018	U128		127	143TTFR4010	U733	✓	56	143TTWD5527	N434	✓	111	145TTDR4017	U140		127
143TTDR4019	U131		127	143TTFR4015	U303		125	143TTWD6001	N454A	✓	111	145TTDR4018	U143		127
143TTDR4022	E121		119	143TTFR4021	U305		125	143TTWD6002	N456A	✓	111	145TTDR4021	E131		119
143TTDR4023	U130		127	143TTFR4028	E824		47	143TTWD6026	N414A	✓	111	145TTDR4022	E134		119
143TTDR4024	E124		119	143TTFR4034	U301		125	143TTWR6028	N626A	✓	110	145TTDR4023	U142		127
143TTDR4025	U133		127	143TTFR4040	U300		125	145TBDR5302	I102	✓	22	145TTDR4024	U145		127
143TTDR4034	E118		119	143TTFR4046	U302		125	145TBDR5303	I145		22	145TTDR4025	E144		120
143TTDR4035	E100		119	143TTFR4302	C201A	✓	53	145TBDR5304	Z404		118	145TTDR4034	E102		119
143TTDR4037	U126		127	143TTFR4303	U304A	✓	125	145TBDR5309	Z304	✓	105	145TTDR4035	E128		119
143TTDR4040	E115		119	143TTFR4329	C220A	✓	53	145TBDR5337	I127	✓	22,168,174	145TTDR4037	U138		127
143TTDR4041	E117		119	143TTFR4333	C230A		53	145TBDR5345	I147	✓	25,152	145TTDR4040	E125		119
143TTDR4042	U122		127	143TTFR5302	C201	✓	53	145TBFR5301	I204		30	145TTDR4041	E127		119
143TTDR4043	U125		127	143TTFR5333	C230		53	145TBFR5302	I205		30	145TTDR4042	U134		127
143TTDR4046	E119		119	143TTFR5376	H700	✓	47	145TBFR5303	I221	✓	30	145TTDR4043	U137		127
143TTDR4047	E116		119	143TTFR5582	E2003	✓	62	145TBFR5305	C282		32	145TTDR4046	E136		119
143TTDR4048	U124		127	143TTFR5642	E2001	✓	62	145TBFR5306	C284		32	145TTDR4047	E129		119



Index

Model Number/Catalog Number

MODEL NO.	CAT. NO.	STOCK	PAGE NO.	MODEL NO.	CAT. NO.	STOCK	PAGE NO.	MODEL NO.	CAT. NO.	STOCK	PAGE NO.	MODEL NO.	CAT. NO.	STOCK	PAGE NO.
145TTDR4048	U136		127	145TTDR6006	GT0509	✓	123	145TTFR4332	C221A	✓	53	145TTTC4026	E837	✓	50
145TTDR4049	U139		127	145TTDR6007	GT0406	✓	123	145TTFR4340	C231A		53	145TTTC4027	E846	✓	50
145TTDR4051	E138		119	145TTDR6013	GT0409	✓	123	145TTFR4378	C250A	✓	53	145TTTN4001	E842	✓	50
145TTDR4060	E104		119	145TTDR6028	U759	✓	42	145TTFR5328	H665	✓	48	145TTTN4003	E841		50
145TTDR4066	E135		119	145TTDR6029	U760	✓	42	145TTFR5330	H666	✓	48	145TTTN4005	E844		50
145TTDR4067	E137		119	145TTDR6030	GT0507	✓	123	145TTFR5340	C231		53	145TTTN4030	U606		51
145TTDR4068	U146		127	145TTDR6031	GT0504	✓	123	145TTFR5341	C232		53	145TTTN4032	U601		50
145TTDR4069	U149		127	145TTDR6034	GT0404	✓	123	145TTFR5359	C403	✓	100	145TTTN4035	E839	✓	50
145TTDR4072	E126		119	145TTDR6036	GT0407	✓	123	145TTFR5360	C401	✓	100	145TTTN4040	E848	✓	51
145TTDR4073	E139		119	145TTDR6039	U246	✓	42	145TTFR5382	C400	✓	100	145TTTN4076	E829	✓	50
145TTDR4074	U148		127	145TTDR6076	U265	✓	42	145TTFR6009	GT1206	✓	66	145TTTN4080	U672	✓	50
145TTDR4075	U151		127	145TTDR6126	U420A	✓	37	145TTFR6033	E2004	✓	62	145TTTN6001	E353	✓	59
145TTDR4076	E728	✓	37	145TTDR6127	U421A		37	145TTFR6035	E2007	✓	62	145TTTN6501	E653	✓	69
145TTDR4078	E785		37	145TTDR6132	U423A	✓	37	145TTFR6040	GT1207	✓	66	145TTTN6505	E852		69
145TTDR4080	E934		37	145TTDR6133	U424A	✓	37	145TTFR6058	GT1204	✓	66	145TTTN6521	E466		69
145TTDR4103	U905		37	145TTDR14007	C102A	✓	40	145TTFR6078	E2002	✓	62	145TTTN6526	E652	✓	69
145TTDR4105	E932		37	145TTDR14049	K622A	✓	40	145TTFR13002	E2106	✓	59	145TTTN6527	E654	✓	70
145TTDR4110	E143		120	145TTDR14087	C162A		40	145TTFR14011	U310A	✓	125	145TTTN6529	E667		69
145TTDR4111	U153		128	145TTDR14088	C150A	✓	40	145TTFR14045	U313A	✓	125	145TTTN6530	E668	✓	70
145TTDR4112	U156		128	145TTDR16008	U906A	✓	42	145TTFR14048	C232A		53	145TTTN6576	E650	✓	69
145TTDR4115	E140		120	145TTDR16010	E932A	✓	42	145TTFR15581	E2152		58	145TTTN6584	E462		69
145TTDR4117	U152		128	145TTDR16017	GT2506	✓	131	145TTFR16001	E2156		59	145TTTN6834	E464	✓	69
145TTDR4118	U155		128	145TTDR16020	GT2406	✓	131	145TTFR16005	GT1406	✓	66	145TTTN6835	E467	✓	70
145TTDR4121	E141		120	145TTDR16301	GT2409	✓	131	145TTFR16020	E2131		59	145TTTN18531	S503		172
145TTDR4123	U154		128	145TTDR16303	GT2509	✓	131	145TTFR16033	E2104	✓	58	145TTTN18532	S553		172
145TTDR4124	U157		128	145TTDR16327	GT2504	✓	131	145TTFR16035	E2107	✓	59	145TTTN18577	S501		172
145TTDR4128	U419	✓	37	145TTDR16330	GT2404	✓	131	145TTFR16038	E2154	✓	58	145TTVR5030	N629	✓	110
145TTDR4130	U923		37	145TTDR16333	GT2407	✓	131	145TTFR16039	E2157	✓	59	145TTVR5301	N652		109
145TTDR4134	U422	✓	37	145TTDR16339	GT2507	✓	131	145TTFR16040	E2129	✓	58	145TTVR5302	N610	✓	110
145TTDR4136	U924		37	145TTDR16054	U923A		37	145TTFR16045	E2132	✓	59	145TTVR5326	N607	✓	110
145TTDR4303	E105		120	145TTDR16059	U924A		37	145TTFR16046	GT1404	✓	66	145TTWD4027	N405	✓	112
145TTDR4307	E142		120	145TTDR16061	E913A	✓	42	145TTFR16047	GT1407	✓	66	145TTWD4029	N418	✓	111
145TTDR4317	E096	✓	119	145TTDR16062	E914A	✓	37,42	145TTFR16079	GT1202	✓	66	145TTWD5528	N438	✓	111
145TTDR4341	C122A	✓	40	145TTDR16077	E934A	✓	42	145TTFR16078	E2102	✓	58	145TTWD6001	N458A	✓	111
145TTDR4354	U135A	✓	127	145TTFN6501	E382		69	145TTFR16080	E2127		58	145TTWD6026	N404A		112
145TTDR4355	U150A		127	145TTFN6521	E383		69	145TTGN4001	U059	✓	81	145TTWD6027	N405A	✓	112
145TTDR4356	U147A	✓	127	145TTFN6835	E386		70	145TTGN4022	C302A		80	145TTWD6029	N418A	✓	111
145TTDR5312	C103	✓	40	145TTFR3002	E2006	✓	62	145TTGN4032	C362	✓	78	145TTWR4029	N321	✓	108
145TTDR5313	M307	✓	119	145TTFR4005	E840		48	145TTGN4035	U021	✓	81	145TTWR4301	N655A	✓	109
145TTDR5314	M308	✓	119	145TTFR4007	E843		48	145TTGN4040	U022	✓	81	145TTWR4326	N654A	✓	109
145TTDR5315	M311	✓	120	145TTFR4011	U310		125	145TTGN4337	C321A	✓	80	145TTWR5301	N655	✓	109
145TTDR5316	M312	✓	120	145TTFR4017	U309		125	145TTGN4338	C322A	✓	80	145TTWR6001	N613A	✓	110
145TTDR5319	M111	✓	128	145TTFR4023	U311		125	145TTGN6501	U059A	✓	82	145TTWR6026	N612A	✓	110
145TTDR5346	M306	✓	119	145TTFR4029	E836		48	145TTGN6526	U002A	✓	82	145TTWR6027	N312A	✓	108
145TTDR5350	M310	✓	119	145TTFR4032	E845		48	145TTGN6527	U003A	✓	82	145TTWR6029	N321A	✓	108
145TTDR5354	M105	✓	127	145TTFR4038	E838	✓	48	145TTGN6536	C362A	✓	78	145TTWR6033	N630	✓	110
145TTDR5356	M109	✓	127	145TTFR4039	E847	✓	48	145TTGN6537	U021A	✓	82	145TTWR6076	N323	✓	108
145TTDR5401	H181	✓	36	145TTFR4044	U313		125	145TTGN6540	U022A	✓	82	160LTC6513	R339A	✓	97
145TTDR5632	E902	✓	37	145TTFR4045	U307		125	145TTGN6549	C363A	✓	78	160LTC6538	R337A	✓	97
145TTDR5633	E903	✓	37	145TTFR4046	U703		56	145TTGN6550	U988A		82	160LTC6588	R335A	✓	97
145TTDR5647	H952		176	145TTFR4048	U306		125	145TTGN6576	U039A	✓	82	160MTC6511	R333A	✓	97
145TTDR5665	E914	✓	37	145TTFR4050	U312		125	145TTGN16532	U987A		82	160MTC6512	R336A	✓	97
145TTDR5701	Y465	✓	170	145TTFR4052	U705		56	145TTGR16002	I512	✓	79	160MTC6536	R334A	✓	97
145TTDR5702	Y466	✓	170	145TTFR4054	U308		125	145TTGR16004	I513	✓	79	160MTC6586	R332A	✓	97
145TTDR5703	Y449	✓	170	145TTFR4070	U706		56	145TTGR16030	I509	✓	79	161L110AA1	AG195	✓	196
145TTDR5704	Y450		170	145TTFR4126	U708		56	145TTGR16038	I508	✓	79	161L110AAG4	A518	✓	196
145TTDR5705	Y451	✓	170	145TTFR4128	U314		125	145TTGR16039	I515	✓	79	161L113AAG1	AG109	✓	195
145TTDR5706	Y452	✓	170	145TTFR4306	C202A	✓	53	145TTGR16040	I514	✓	79	161L113AAG2	AG110	✓	195
145TTDR6002	U247	✓	42	145TTFR4307	C236A	✓	54	145TTGR16076	I504	✓	79	161L113AAG3	AG111	✓	195
145TTDR6004	GT0506	✓	123	145TTFR4310	U363	✓	125	145TTGR16080	I505		79	161L113AAG4	AG112	✓	195

Model Number/Catalog Number

MODEL NO.	CAT. NO.	STOCK	PAGE NO.	MODEL NO.	CAT. NO.	STOCK	PAGE NO.	MODEL NO.	CAT. NO.	STOCK	PAGE NO.	MODEL NO.	CAT. NO.	STOCK	PAGE NO.
161L113AAG5	AG113	✓	195	182TTDB6007	GT0412	✓	123	182TTDW7211	Y409A	✓	170	182TTFW14026	M876A		138
161L113AAG6	AG114	✓	195	182TTDB6008	GT0512	✓	123	182TTDW7412	Y1484	✓	170	182TTFW16001	E2109	✓	59
161L113AAG9	AG115	✓	195	182TTDB6012	GT2412	✓	131	182TTDW7411	Y467A	✓	170	182TTFW16002	E2159		59
161L113ADG1	AG125	✓	195	182TTDB6013	GT2512	✓	131	182TTDW7413	Y1453	✓	170	182TTFW16020	E2134		59
161L113ADG3	AG127	✓	195	182TTDB6026	GT0010	✓	45	182TTDW14008	C104B	✓	40	182TTFW16021	C381B	✓	56
161L113ADG4	AG128	✓	195	182TTDB6032	GT0410	✓	123	182TTDW14011	U165A	✓	128	182TTFW16026	E2110	✓	59
161L113ADG5	AG129	✓	195	182TTDB6033	GT0510	✓	123	182TTDW14029	E097	✓	120	182TTFW16027	C383B	✓	56
161L113ADG14	AG130	✓	195	182TTDB6037	GT2410	✓	131	182TTDW16008	U908A	✓	42	182TTFW16030	C382B	✓	56
161L185AAG1	AG192	✓	190	182TTDB6038	GT2510	✓	131	182TTDW16009	U914	✓	42	182TTFW16038	E2160	✓	59
161L186AAG1	AG195	✓	191	182TTDB6076	GT0005	✓	45	182TTDW16010	U402C	✓	41	182TTFW16040	E2135	✓	59
161L187BAG1	A534	✓	190	182TTDB7325	M1315	✓	120	182TTDW16048	U425B		38	182TTFW16076	E2105	✓	58
161L187BCG1	A535	✓	190	182TTDB7355	M313	✓	120	182TTDW16029	E915B	✓	42	182TTFW16080	E2130		58
161L188BAG1	A536	✓	191	182TTDB7601	M1316	✓	120	182TTDW16049	U426B	✓	38	182TTFW16082	E2155		58
161L188BCG1	A537	✓	191	182TTDR4001	E704	✓	38	182TTDW16082	U925A		38	182TTGN4068	C323A	✓	80
161L197ABG1	A958	✓	200	182TTDR4036	E147		120	182TTFB6003	GT1209	✓	66	182TTGN4315	C303A	✓	80
161L197ABG11	A959	✓	200	182TTDR4075	U925		38	182TTFB6004	GT1309	✓	66	182TTGN6501	U060A	✓	81
161L198AAG9	A956	✓	200	182TTDR4104	E933		38	182TTFB6007	GT1409	✓	66	182TTGN6526	U004A	✓	82
161L198AAG10	A957	✓	200	182TTDR4106	U908		38	182TTFB6028	GT1210	✓	66	182TTGN6530	U023A	✓	82
161L190AAP1	AG697	✓	200	182TTDR4113	U168		128	182TTFB6029	GT1310	✓	66	182TTGN6536	C368A		78
161L528AAG1	AG234	✓	199	182TTDR4116	E150		120	182TTFB6032	GT1410	✓	66	182TTGN6541	U989A		82
180LTFC6538	R343A	✓	97	182TTDR4117	E152		120	182TTFB6078	GT1205	✓	66	182TTGN6569	C364A	✓	78
180LTFC6588	R338A	✓	97	182TTDR4118	U164		128	182TTFB6079	GT1305	✓	66	182TTGN6576	U040A	✓	82
180MTFC6511	R342A	✓	97	182TTDR4119	U167		128	182TTFC6001	GT1009	✓	63	182TTGS4030	U023	✓	81
180MTFC6536	R340A	✓	97	182TTDR4122	E151		120	182TTFC6002	U602A	✓	59	182TTLL7034	C405	✓	100
182TBF5301	I206	✓	30	182TTDR4123	E154		120	182TTFC6005	GT1109	✓	63	182TTSS6001	E216	✓	59
182TBF5326	I212	✓	30	182TTDR4124	U166		128	182TTFC6006	U604A	✓	59	182TTSS6030	E303	✓	59
182TCDR7013	Z309		105	182TTDR4125	U169		128	182TTFC6026	GT1010	✓	63	182TTSS6501	E601	✓	70
182TCDR7074	Z405	✓	118	182TTDR4140	E145		120	182TTFC6027	U607A	✓	59	182TTSS6505	E853		70
182TCDR7318	Z406	✓	118	182TTDR4142	U158		128	182TTFC6030	GT1110	✓	63	182TTSS6526	E616	✓	70
182TCDR7354	Z424		126	182TTDR4143	U161		128	182TTFC6031	U609A	✓	59	182TTSS6530	E669	✓	70
182TCDR8005	Z425		126	182TTDR4146	E146		120	182TTFC6076	GT1005	✓	63	182TTSS6538	E470	✓	70
182TCDR8007	C173		27	182TTDR4148	U160		128	182TTFC6077	E823A	✓	58	182TTSS6576	E632	✓	69
182TCDR17079	I141		21	182TTDR4149	U163		128	182TTFC6080	GT1105	✓	63	182TTSS6578	E465		69
182TCDW7001	I103A	✓	22	182TTDR5338	M170	✓	128	182TTFC6081	E001	✓	58	182TTSS18532	S506		172
182TCDW7026	I112A	✓	22	182TTDR7211	Y409	✓	170	182TTFN4101	L409A	✓	50	182TTWD6031	N406A	✓	112
182TCDW7074	Z405A	✓	118	182TTDR7411	Y467	✓	170	182TTFN6557	U867A		68	182TTWW4026	N1614	✓	110
182TCDW7318	Z406A	✓	118	182TTDR7413	Y453	✓	170	182TTFR4013	U736		56	182TTWW4028	N656B	✓	109
182TCFW7072	Z119A	✓	101	182TTDR7601	M316	✓	120	182TTFR4015	U315		125	182TTWW6026	N614B	✓	110
182TCFW9061	Z112A	✓	102	182TTDR8353	H953		176	182TTFR4021	U317		125	182TTWW6027	N314B	✓	108
182TEFR5326	Z617	✓	94	182TTDR14026	M803A		136	182TTFR4056	U320		125	182TTWW7026	N1656	✓	109
182THES8048	Y980	✓	92	182TTDR14027	M801A		136	182TTFR4320	C381	✓	56	184TBDP5301	Z504		168
182THFR5326	Y530		88	182TTDW4002	E107A	✓	120	182TTFR6001	E2009A	✓	62	184TBDP5326	Z502	✓	168
182THFR5329	Y370	✓	88	182TTDW4027	E1904	✓	38	182TTFR7325	C203	✓	54	184TBDP7324	Z313		105
182THFR5330	Y371		88	182TTDW4028	C123B	✓	40	182TTFS4001	U602	✓	50	184TBDP7375	I119		168,174
182THFR7729	Y999	✓	88	182TTDW4030	E1915	✓	38	182TTFS4005	U604		50	184TBDP7628	I305		174
182THFR7730	Y270	✓	88	182TTDW4033	E106A	✓	120	182TTFS6501	E390		70	184TBDP7631	I128	✓	174
182THFS19101	W504		74	182TTDW4036	E147A		120	182TTFS6505	E392		70	184TBDP7632	I131	✓	174
182THFW7729	Y1999	✓	88	182TTDW4083	E1799	✓	37	182TTFS6576	E380		69	184TBDP7634	I308		174
182THFW7730	Y1270	✓	88	182TTDW4116	E150A		120	182TTFW4027	C223B	✓	54	184TBDW7001	I108A	✓	22168
182THL7726	Y541	✓	89	182TTDW4135	E148A	✓	120	182TTFW4040	U1608	✓	48	184TBDW7009	Z307A	✓	105
182THL7736	Y558	✓	89	182TTDW4147	E149A		120	182TTFW4302	U316A	✓	125	184TBDW7026	I144A	✓	22,168
182THL17041	Y286	✓	88	182TTDW4303	E098	✓	120	182TTFW4327	U605A	✓	48	184TBDW7369	Z1124		141
182THS8028	Y527	✓	91	182TTDW4304	E153A	✓	120	182TTFW4330	U319A	✓	125	184TBDW7630	I130A	✓	174
182THS8048	Y988	✓	93	182TTDW4338	U159A	✓	128	182TTFW4345	C383A	✓	56	184TBDW7631	I128A	✓	174
182THS9001	W517		75	182TTDW4339	U162A		128	182TTFW6001	E2009	✓	62	184TBDW7632	I131A	✓	174
182THS9026	W519	✓	75	182TTDW6001	U1248	✓	42	182TTFW6026	E2010	✓	62	184TBDW7656	Z506A		168
182THS9076	W509		74	182TTDW6030	E1930	✓	42	182TTFW6076	E2005	✓	62	184TBDW17007	Z408A	✓	118
182THS19033	W520		75	182TTDW6076	U1266	✓	42	182TTFW7634	C1223	✓	54	184TBDW17008	I104A	✓	22
182THW7726	Y998A		88	182TTDW7101	H182A		37	182TTFW14004	C203B	✓	54	184TBDW17011	Z427A	✓	126
182TTDB6001	GT0012	✓	45	182TTDW7203	Y485A		170	182TTFW14005	M875A		138	184TBF7315	Z433	✓	118



Index

Model Number/Catalog Number

MODEL NO.	CAT. NO.	STOCK	PAGE NO.	MODEL NO.	CAT. NO.	STOCK	PAGE NO.	MODEL NO.	CAT. NO.	STOCK	PAGE NO.	MODEL NO.	CAT. NO.	STOCK	PAGE NO.
184TBF7726	I214	✓	30	184TTDR4123	U178		128	184TTFB6028	GT1213	✓	66	184TTFW16020	E2137		59
184TBFW7034	I315A	✓	32,101,175	184TTDR4124	U181		128	184TTFB6029	GT1313	✓	66	184TTFW16026	E2113	✓	59
184TBFW7041	I314A	✓	32,101,175	184TTDR4140	E155		120	184TTFB6032	GT1413	✓	66	184TTFW16027	C386B	✓	56
184TBFW7070	Z114A	✓	102	184TTDR4141	E157		120	184TTFB6078	GT1208	✓	66	184TTFW16038	E2163	✓	59
184TBFW7315	Z433A	✓	118	184TTDR4142	U170		128	184TTFB6079	GT1308	✓	66	184TTFW16029	C387B	✓	56
184TBFW7701	I223A	✓	30	184TTDR4143	U173		128	184TTFB6001	GT1012	✓	63	184TTFW16040	E2138	✓	59
184TBFW7726	I214A	✓	30	184TTDR4146	E156		120	184TTFB6002	U613A	✓	59	184TTFW16051	C380B	✓	56
184TBFW7737	Z121A	✓	101	184TTDR4147	E159		120	184TTFB6005	GT1112	✓	63	184TTFW16076	E2108	✓	59
184TBFW17044	I213A	✓	30	184TTDR4148	U172		128	184TTFB6006	U615A	✓	59	184TTFW16079	E2158		59
184TBFW17045	Z120A	✓	101	184TTDR4149	U175		128	184TTFB6026	GT1013	✓	63	184TTFW16081	E2133		59
184TCDR7011	Z408	✓	118	184TTDR4153	U427	✓	38	184TTFB6027	U618A	✓	59	184TTGN4072	C324A	✓	80
184TCDR7047	Z407	✓	118	184TTDR4173	M804A		136	184TTFB6030	GT1113	✓	63	184TTGN4313	C304A	✓	80
184TCDR7076	I142		22	184TTDR4178	E918		37	184TTFB6031	U620A	✓	59	184TTGN6501	U061A	✓	82
184TCDR7615	Z305	✓	105	184TTDR7215	Y412	✓	170	184TTFB6076	GT1008	✓	63	184TTGN6526	U005A	✓	82
184TCDR7617	Z306	✓	105	184TTDR7230	Y468	✓	170	184TTFB6077	E849A	✓	59	184TTGN6530	U024A	✓	82
184TCDR7626	Z426		126	184TTDR7286	Y454	✓	170	184TTFB6080	GT1108	✓	63	184TTGN6537	C369A		78
184TCDR7627	C174		27	184TTDR7287	Y486	✓	170	184TTFB6081	E002	✓	59	184TTGN6544	U990A		82
184TCDR7909	Z427	✓	126	184TTDR7604	M116	✓	128	184TTFN4102	L410B	✓	50	184TTGN6575	C365A	✓	78
184TCDW7026	I113A	✓	22	184TTDR7611	Y302	✓	105	184TTFN6555	U868A	✓	68	184TTGN6576	U041A	✓	82
184TCDW7047	Z407A	✓	118	184TTDR7612	Y303	✓	105	184TTFN6555	L410A	✓	50	184TTGS1001	U941	✓	77
184TCDW7615	Z305A	✓	105	184TTDR8039	M163		128	184TTFR4003	U611		49	184TTGS1026	U942	✓	77
184TCDW7617	Z306A	✓	105	184TTDR9040	H954	✓	176	184TTFR4005	U614		49	184TTGS4030	U024	✓	81
184TCFW9057	Z113A	✓	102	184TTDW4002	E109A	✓	120	184TTFR4013	U738		56	184TTTL7041	C406	✓	100
184THFR7726	Y372	✓	88	184TTDW4003	E937A		38	184TTFR4021	U323		125	184TTTL7083	C404	✓	100
184THFR7736	Y373		88	184TTDW4110	E163A	✓	120	184TTFR4038	U616	✓	49	184TTTL7084	C402	✓	100
184THFS9001	W523	✓	75	184TTDW4027	E1905	✓	38	184TTFR4076	E995	✓	48	184TTTS6576	E633	✓	70
184THFS9026	W525	✓	75	184TTDW4030	E1916	✓	38	184TTFR4345	C387	✓	56	184TTTS6582	E468	✓	70
184THFS9030	W526	✓	75	184TTDW4034	E108A	✓	120	184TTFR8914	M216	✓	130	184TTTS18577	S504		172
184THFS19006	W524		75	184TTDW4039	U299		128	184TTFR4005	U615	✓	50	184TTTS18578	S554		172
184THFW7726	Y1372	✓	88	184TTDW4135	E158A	✓	120	184TTFR4030	U620	✓	50	184TTWD14031	N407	✓	112
184THFW7736	Y373A	✓	88	184TTDW4136	U171A		128	184TTFR6501	E602	✓	70	184TTWD6031	N407A	✓	112
184THHL7726	Y543	✓	89	184TTDW4153	U427A	✓	38	184TTFR6505	E655	✓	70	184TTWW4002	N657B	✓	109
184THHL7736	Y559	✓	89	184TTDW6001	U249A	✓	43	184TTFR6526	E617	✓	70	184TTWW4028	N658B	✓	109
184THHL7776	Y540	✓	89	184TTDW6031	E1931	✓	42	184TTFR6530	E670	✓	70	184TTWW6001	N615B	✓	110
184THL17038	Y287	✓	88	184TTDW6076	U1267	✓	42	184TTFR6576	E388		70	184TTWW6003	N317A		108
184THS8028	Y564	✓	91	184TTDW7101	H183A		37	184TTFR6810	E472	✓	70	184TTWW6004	N315A		108
184THS8056	Y989	✓	93	184TTDW7209	Y1487	✓	170	184TTFR6844	E473	✓	70	184TTWW6026	N616B	✓	110
184THS9076	W515		74	184TTDW7215	Y412A	✓	170	184TTFR7290	Y380		169	184TTWW6027	N316B	✓	108
184TTDB4026	E719	✓	38	184TTDW7230	Y468A	✓	170	184TTFW4009	U322A	✓	125	200LTC6511	R345A	✓	97
184TTDB6001	GT0015	✓	45	184TTDW7286	Y454A	✓	170	184TTFW4040	U1619	✓	49	200LTC6513	R348A	✓	97
184TTDB6007	GT0415	✓	123	184TTDW7287	Y486A	✓	170	184TTFW4340	C386A	✓	56	200LTC6538	R346A	✓	97
184TTDB6008	GT0515	✓	123	184TTDW7357	M1317	✓	120	184TTFW4345	C387A	✓	56	200LTC6588	R341A	✓	97
184TTDB6012	GT2415	✓	131	184TTDW7358	M115A	✓	128	184TTFW4380	C1380	✓	56	200LTC6589	R344A	✓	97
184TTDB6013	GT2515	✓	131	184TTDW7611	Y302A	✓	105	184TTFW4727	U616A	✓	49	213TBFW7001	I224	✓	30
184TTDB6026	GT0013	✓	45	184TTDW7612	Y1303	✓	105	184TTFW4760	U325A	✓	125	213TBFW7010	Z434	✓	118
184TTDB6032	GT0413	✓	123	184TTDW14001	E109A	✓	120	184TTFW4914	U372	✓	130	213TBFW7026	I216	✓	30
184TTDB6033	GT0513	✓	123	184TTDW14017	C105B	✓	40	184TTFW4915	U360	✓	125	213TBFW7027	Z117	✓	102
184TTDB6037	GT2413	✓	131	184TTDW14027	C124B	✓	40	184TTFW6001	E2012	✓	62	213TCDW7001	I105	✓	22,168
184TTDB6038	GT2513	✓	131	184TTDW14078	C152A		40	184TTFW6026	E2013	✓	62	213TCDW7002	Z410	✓	118
184TTDB6076	GT0008	✓	45	184TTDW14079	U177A	✓	128	184TTFW6076	E2008	✓	62	213TCDW7003	Z429	✓	126
184TTDB7357	M317	✓	120	184TTDW16001	U404B	✓	41	184TTFW7727	H1668	✓	49	213TCDW7026	I117		22
184TTDR4034	E108	✓	120	184TTDW16027	E938A	✓	43	184TTFW8617	C1238	✓	54	213TCDW7027	Z409	✓	118
184TTDR4105	E938		38	184TTDW16038	U428B	✓	38	184TTFW8641	C1224	✓	54	213TCDW7028	Z428		126
184TTDR4112	U180		128	184TTDW16040	E916B	✓	42	184TTFW14004	C204B	✓	54	213TCDW7076	I143		22
184TTDR4115	E160		120	184TTDW16041	U917		38	184TTFW14021	C238B	✓	54	213THES8053	Y981	✓	92
184TTDR4116	E162		120	184TTDW16043	U403A		41	184TTFW14026	M879A		138	213THFS8028	Y595	✓	91
184TTDR4117	U176		128	184TTDW16076	U915	✓	42	184TTFW14028	U326A		125	213THFS9026	W532	✓	75
184TTDR4118	U179		128	184TTFB6003	GT1212	✓	66	184TTFW16001	E2112	✓	59	213THFS9030	W533	✓	75
184TTDR4121	E161		120	184TTFB6004	GT1312	✓	66	184TTFW16002	E2162		59	213THFS9076	W521	✓	75
184TTDR4122	E164		120	184TTFB6007	GT1412	✓	66	184TTFW16006	C385B	✓	56	213THFW7726	Y994	✓	88

Model Number/Catalog Number

MODEL NO.	CAT. NO.	STOCK	PAGE NO.	MODEL NO.	CAT. NO.	STOCK	PAGE NO.	MODEL NO.	CAT. NO.	STOCK	PAGE NO.	MODEL NO.	CAT. NO.	STOCK	PAGE NO.
213THFW7736	Y995	✓	88	213TTDW7049	M117	✓	128	213TTFW4345	C391	✓	57	215TBFW7027	I217	✓	30
213THL7726	Y545	✓	89	213TTDW7053	H955		176	213TTFW6001	E2015	✓	62	215TBFW7028	Z115	✓	102
213THL7736	Y560	✓	89	213TTDW7201	Y489	✓	170	213TTFW6026	E2016	✓	62	215TBFW7029	Z122	✓	101
213THL7776	Y542	✓	89	213TTDW7202	Y488		170	213TTFW6076	E2011	✓	62	215TBFW7044	Z116	✓	102
213THS8038	Y565	✓	91	213TTDW14013	U189A	✓	129	213TTFW7028	H669	✓	49	215TCDW7002	Z412	✓	118
213THS8071	Y990	✓	93	213TTDW14014	C106A	✓	40	213TTFW14010	M881A		138	215TCDW7003	Z308	✓	105
213THS9001	W530	✓	75	213TTDW14054	M807A		136	213TTFW14011	C205A	✓	54	215TCDW7004	Z431	✓	126
213THS19005	W531		75	213TTDW14057	C125A		40	213TTFW14045	C225A	✓	54	215TCDW7012	Z314		105
213TTDB6001	GT0018	✓	45	213TTDW14059	U186A		128	213TTFW14080	M877A		138	215TCDW17002	I106	✓	22
213TTDB6007	GT0418	✓	123	213TTDW14084	M802A		136	213TTFW14081	C253A		54	215THFS8029	Y596	✓	91
213TTDB6008	GT0518	✓	123	213TTDW14102	H184A		37	213TTFW16001	E2115	✓	59	215THFS9001	W537	✓	75
213TTDB6037	GT2416	✓	131	213TTDW16010	U432A		41	213TTFW16008	C389A	✓	57	215THFS9026	W539	✓	75
213TTDB6038	GT2516	✓	131	213TTDW16060	U430A	✓	38	213TTFW16020	E2140		59	215THFS9076	W527	✓	75
213TTDB6026	GT0016	✓	45	213TTDW16061	U926A		38	213TTFW16026	E2116	✓	59	215THFS9101	W522		75
213TTDB6032	GT0416	✓	123	213TTDW16063	U405A	✓	41	213TTFW16035	C390A	✓	57	215THFS19006	W538		75
213TTDB6033	GT0516	✓	123	213TTFBA6003	GT1215	✓	66	213TTFW16036	C391A	✓	57	215THFS19033	W540	✓	75
213TTDB6012	GT2418	✓	131	213TTFBA6004	GT1315	✓	66	213TTFW16040	E2141	✓	59	215THFS19077	W528		75
213TTDB6013	GT2518	✓	131	213TTFBA6007	GT1415	✓	66	213TTFW16076	E2111	✓	59	215THFW7726	Y996	✓	88
213TTDB6076	GT0011	✓	45	213TTFBA6028	GT1216	✓	66	213TTFW16078	C384A	✓	56	215THFW7736	Y997		88
213TTDBA4028	E906	✓	38	213TTFBA6029	GT1316	✓	66	213TTFW16081	E2136		59	215THL7726	Y547	✓	89
213TTDBA7022	M1323	✓	121	213TTFBA6032	GT1416	✓	66	213TTFW16082	E2161		59	215THL7736	Y561	✓	89
213TTDBA7047	M321	✓	121	213TTFBA6078	GT1211	✓	66	213TTGN4067	C325A	✓	80	215THL7776	Y544	✓	89
213TTDBA7048	M1322	✓	121	213TTFBA6079	GT1311	✓	66	213TTGN6501	U062A	✓	83	215THS8038	Y566	✓	91
213TTDC6001	U764	✓	43	213TTFC4076	U610	✓	50	213TTGN6526	U006A	✓	83	215THS8071	Y991	✓	93
213TTDC6003	U283	✓	43	213TTFC6001	GT1015	✓	63	213TTGN6528	C366A	✓	78	215TTDB6001	GT0021	✓	45
213TTDC6026	U763	✓	43	213TTFC6002	U624A	✓	59	213TTGN6536	C370A		78	215TTDB6007	GT0421	✓	123
213TTDC6029	U281	✓	43	213TTFC6005	GT1115	✓	63	213TTGN6540	U991A		83	215TTDB6008	GT0521	✓	123
213TTDC6076	U268	✓	42	213TTFC6006	U671A	✓	59	213TTGN6576	U042A	✓	82	215TTDB6012	GT2421	✓	131
213TTDC6079	U279	✓	42	213TTFC6026	GT1016	✓	63	213TTGN16537	U025A	✓	83	215TTDB6013	GT2521	✓	131
213TTDW4003	E939		38	213TTFC6027	U629A	✓	59	213TTGS1001	U944	✓	77	215TTDB6026	GT0019	✓	45
213TTDW4007	E174		121	213TTFC6030	GT1116	✓	63	213TTGS1076	U940	✓	77	215TTDB6032	GT0419	✓	123
213TTDW4008	E172		121	213TTFC6031	U631A	✓	59	213TTGS4030	U025	✓	81	215TTDB6033	GT0519	✓	123
213TTDW4009	E170		121	213TTFC6076	GT1011	✓	63	213TTGS14015	C305	✓	80	215TTDB6037	GT2419	✓	131
213TTDW4010	E171		121	213TTFC6077	U610A	✓	59	213TTTL7034	C407	✓	100	215TTDB6038	GT2519	✓	131
213TTDW4011	U188		129	213TTFC6080	GT1111	✓	63	213TTTS6001	E218	✓	59	215TTDB6076	GT0014	✓	45
213TTDW4012	U190		129	213TTFC6081	E003	✓	59	213TTTS6501	E603	✓	70	215TTDBA7047	M325	✓	121
213TTDW4013	U191		129	213TTFN4103	L411A	✓	50	213TTTS6502	E475	✓	70	215TTDC6001	U766	✓	43
213TTDW4014	U193		129	213TTFN6550	U869A	✓	68	213TTTS6505	E656	✓	70	215TTDC6003	U286	✓	43
213TTDW4022	E111		121	213TTFS4005	U671	✓	50	213TTTS17077	S507		172	215TTDC6026	U765	✓	43
213TTDW4023	E173	✓	121	213TTFS4030	U631	✓	50	213TTTS17078	S557		172	215TTDC6029	U284	✓	43
213TTDW4025	U192		129	213TTFS6501	E396		70	213TTWD6031	N408A	✓	112	215TTDC6076	U269	✓	42
213TTDW4030	E758	✓	38	213TTFS6526	E618	✓	70	213TTWR4001	N659A	✓	109	215TTDC6079	U280	✓	42
213TTDW4033	E167		121	213TTFS6530	E671	✓	70	213TTWR4027	N318	✓	108	215TTDW4003	E788	✓	38
213TTDW4038	E169		121	213TTFS6531	E476	✓	70	213TTWR6002	N617A	✓	110	215TTDW4007	E184		121
213TTDW4039	U184		128	213TTFS6576	E634	✓	70	213TTWR6026	N618A	✓	110	215TTDW4008	E180		121
213TTDW4041	E166		121	213TTFS6594	E471	✓	70	213TTWR6027	N318A	✓	108	215TTDW4009	E181		121
213TTDW4042	E165		121	213TTFS7238	Y381		169	213TTWR7026	N660		109	215TTDW4010	E182		121
213TTDW4044	U182		128	213TTFW4003	U622		49	215TBDR7361	Z125		141	215TTDW4011	U200		129
213TTDW4045	U405	✓	41	213TTFW4005	U625		49	215TBDW7013	Z315		105	215TTDW4012	U202		129
213TTDW4047	E110		121	213TTFW4007	U740		57	215TBDW7026	I115	✓	22,168	215TTDW4013	U203		129
213TTDW4048	E168		121	213TTFW4008	U742		57	215TBDW7027	Z413	✓	118	215TTDW4014	U205		129
213TTDW4049	U183		128	213TTFW4009	U327		125	215TBDW7028	I116	✓	22,168	215TTDW4022	E113	✓	121
213TTDW4051	U185		128	213TTFW4010	U331		125	215TBDW7029	Z411	✓	118	215TTDW4023	E183		121
213TTDW4052	U187		128	213TTFW4011	U328		130	215TBDW7030	Z432		126	215TTDW4025	U204		129
213TTDW4070	U429		38	213TTFW4012	U332		130	215TBDW7045	Z430		126	215TTDW4028	E907	✓	38
213TTDW4071	U926		38	213TTFW4022	U329		125	215TBDW7079	I144		22	215TTDW4030	E759	✓	38
213TTDW4078	U907	✓	38	213TTFW4028	U627		49	215TBDW7362	Z126		141	215TTDW4032	E179		121
213TTDW7022	M323	✓	121	213TTFW4030	U630	✓	49	215TBFW7001	I225	✓	30	215TTDW4041	E175		121
213TTDW7023	M324	✓	121	213TTFW4038	U335		125	215TBFW7010	Z435	✓	118	215TTDW4042	E176		121
213TTDW7024	M118	✓	129	213TTFW4047	U334	✓	125	215TBFW7026	I215	✓	30	215TTDW4043	E177		121



Index

Model Number/Catalog Number

MODEL NO.	CAT. NO.	STOCK	PAGE NO.	MODEL NO.	CAT. NO.	STOCK	PAGE NO.	MODEL NO.	CAT. NO.	STOCK	PAGE NO.	MODEL NO.	CAT. NO.	STOCK	PAGE NO.
215TTDW4044	U194		129	215TTFS6526	E619	✓	70	215TTWR7026	N661		109	254TTDX4315	U437		41
215TTDW4047	E112		121	215TTFS6527	E479	✓	70	225MTFC6501	R500	✓	97	254TTDX4340	U208		129
215TTDW4048	E178		121	215TTFS6530	E672	✓	70	225MTFC6526	R501	✓	97	254TTDX4341	U211		129
215TTDW4049	U195		129	215TTFS6576	E635	✓	70	225MTFC6586	R347A	✓	97	254TTDX4343	E185		121
215TTDW4051	U196		129	215TTFS6580	E683		70	225STFC6526	R349A	✓	97	254TTDX4344	E186		121
215TTDW4052	U199		129	215TTFS6807	E478	✓	70	250MTFC6501	R503	✓	97	254TTDX4345	E187		121
215TTDW4053	U197		129	215TTFS6881	E474	✓	70	250MTFC6526	R504	✓	97	254TTDX7008	M330	✓	121
215TTDW4071	M810A		136	215TTFS7290	Y382	✓	169	250MTFC6586	R350A	✓	97	254TTDX7042	M121	✓	129
215TTDW4078	E935	✓	38	215TTFS14103	L421A	✓	50	254THEN8058	Y982	✓	92	254TTDX7043	M122	✓	129
215TTDW4315	U435		41	215TTFW4003	U634		49	254THEN8059	Y983	✓	92	254TTDX7046	M353	✓	121
215TTDW4335	U433	✓	41	215TTFW4005	E821		49	254THFNA8038	Y597	✓	91	254TTDX7201	Y470		170
215TTDW7022	M327	✓	121	215TTFW4013	U743		57	254THFNA9001	W544	✓	75	254TTDX7208	Y418	✓	170
215TTDW7023	M328	✓	121	215TTFW4014	U336		126	254THFNA9026	W546	✓	75	254TTDX7278	Y456	✓	170
215TTDW7025	M168		129	215TTFW4015	U338		126	254THFNA9030	W547		75	254TTDX7377	Y203		173
215TTDW7048	M326	✓	121	215TTFW4022	U337		126	254THFNA9076	W534	✓	75	254TTDX8338	H957		176
215TTDW7049	M119	✓	129	215TTFW4028	E822		49	254THFNA9101	W529		75	254TTDX14062	E114A	✓	121
215TTDW7050	M167		129	215TTFW4030	U640	✓	49	254THTL5726	Y549	✓	89	254TTDX14064	M814A		136
215TTDW7053	H956	✓	176	215TTFW4033	U718		57	254THTL5736	Y562	✓	89	254TTDX14088	M808A		136
215TTDW7201	Y491		170	215TTFW4035	U339		126	254THTL5776	Y546	✓	89	254TTDX14089	C155A		40
215TTDW7203	Y415	✓	170	215TTFW4036	U341		126	254THTNA8058	Y509	✓	91	254TTDX14104	H186A	✓	38
215TTDW7204	Y455	✓	170	215TTFW4047	U340		126	254THTNA8071	Y992	✓	93	254TTFCA6002	U644A	✓	60
215TTDW7205	Y469	✓	170	215TTFW4345	C394		57	254TTDC6001	U768	✓	43	254TTFCA6006	U638A	✓	60
215TTDW7301	Y304	✓	105	215TTFW6001	E2018	✓	62	254TTDC6003	U289	✓	43	254TTFCA6027	U647B	✓	60
215TTDW7376	Y201		173	215TTFW6026	E2019	✓	62	254TTDC6026	U767	✓	43	254TTFCA6031	U648A	✓	60
215TTDW7377	Y202	✓	173	215TTFW6076	E2014	✓	62	254TTDC6029	U287	✓	43	254TTFCA6077	U633A	✓	59
215TTDW14018	M813A		136	215TTFW14021	M884A		138	254TTDC6076	U254	✓	43	254TTFCA6081	E005	✓	59
215TTDW14020	U201A	✓	129	215TTFW14022	C237A	✓	54	254TTDC6079	U282	✓	43	254TTFCA6001	GT1021	✓	63
215TTDW14071	C126A		40	215TTFW14024	C206A	✓	54	254TTDCA6001	GT0024	✓	45	254TTFCA6003	GT1221	✓	67
215TTDW14073	U198A		129	215TTFW14040	M885A		138	254TTDCA6007	GT0424	✓	124	254TTFCA6005	GT1121	✓	63
215TTDW14087	M805A		136	215TTFW14041	C226A	✓	54	254TTDCA6008	GT0524	✓	124	254TTFCA6007	GT1421	✓	67
215TTDW14110	H185A		38	215TTFW14083	M880A		138	254TTDCA6012	GT2424	✓	132	254TTFCA6026	GT1022	✓	63
215TTDW16061	U433A		41	215TTFW14084	C254A		54	254TTDCA6013	GT2524	✓	132	254TTFCA6028	GT1222	✓	67
215TTDW17206	Y490		170	215TTFW14301	U357	✓	126	254TTDCA6026	GT0022	✓	45	254TTFCA6030	GT1122	✓	63
215TTFBA4026	E1956	✓	49	215TTFW14302	U366		130	254TTDCA6032	GT0422	✓	123	254TTFCA6032	GT1422	✓	67
215TTFBA6003	GT1218	✓	67	215TTFW16001	E2118	✓	60	254TTDCA6033	GT0522	✓	123	254TTFCA6076	GT1017	✓	63
215TTFBA6004	GT1318	✓	66	215TTFW16005	C392A	✓	57	254TTDCA6037	GT2422	✓	131	254TTFCA6078	GT1217	✓	66
215TTFBA6007	GT1418	✓	67	215TTFW16020	E2143		60	254TTDCA6038	GT2522	✓	131	254TTFCA6080	GT1117	✓	63
215TTFBA6028	GT1219	✓	67	215TTFW16026	E2119	✓	60	254TTDCA6076	GT0017	✓	45	254TTFL4006	U344		126
215TTFBA6029	GT1319	✓	66	215TTFW16040	E2144	✓	60	254TTDN16056	U436A	✓	41	254TTFL4009	U343		130
215TTFBA6032	GT1419	✓	67	215TTFW16041	C393A	✓	57	254TTDX4006	E191		121	254TTFL4010	U346		126
215TTFBA6078	GT1214	✓	66	215TTFW16042	C394A		57	254TTDX4007	E190		121	254TTFL4011	U356		130
215TTFBA6079	GT1314	✓	66	215TTFW16076	E2114	✓	59	254TTDX4008	U214		129	254TTFL4027	U646A		49
215TTFCA6001	GT1018	✓	63	215TTFW16079	C388A	✓	56	254TTDX4010	U215		129	254TTFL4031	U348		126
215TTFCA6002	U636A	✓	60	215TTFW16080	E2139		59	254TTDX4012	U216		129	254TTFL4033	U721		57
215TTFCA6005	GT1118	✓	63	215TTFW16081	E2164		59	254TTDX4014	U212		129	254TTFL4034	U347		126
215TTFCA6006	U637A	✓	60	215TTGN4065	C326A	✓	80	254TTDX4015	E193		121	254TTFL4035	U723		57
215TTFCA6026	GT1019	✓	63	215TTGN6501	U063A	✓	83	254TTDX4016	U217		129	254TTFL4036	U349		126
215TTFCA6027	U639A	✓	60	215TTGN6526	U007A	✓	83	254TTDX4017	U213		129	254TTFL5003	M213	✓	130
215TTFCA6030	GT1119	✓	63	215TTGN6528	C367A	✓	78	254TTDX4018	U900		38	254TTFL14004	U643		49
215TTFCA6031	U641A	✓	60	215TTGN6539	U992A		83	254TTDX4019	E192		121	254TTFL14005	U645		49
215TTFCA6076	GT1014	✓	63	215TTGN6576	U043A	✓	82	254TTDX4020	E194		121	254TTFL14008	U345A	✓	130
215TTFCA6077	U621A	✓	59	215TTGN16532	U026A	✓	83	254TTDX4024	E195		121	254TTFL14009	C207A		54
215TTFCA6080	GT1114	✓	63	215TTGS4030	U026	✓	81	254TTDX4028	E908	✓	38	254TTFL14037	C227A	✓	54
215TTFCA6081	E004	✓	59	215TTGS14020	C306	✓	80	254TTDX4030	E760	✓	38	254TTFL14078	C255A		54
215TTFN6546	U870A	✓	68	215TTTL7050	C408	✓	100	254TTDX4039	E188		121	254TTFL16001	E2121	✓	60
215TTFS4005	U637		51	215TTTS17077	S510	✓	172	254TTDX4041	U210		129	254TTFL16020	E2146		60
215TTFS4030	U641	✓	51	215TTTS17078	S560	✓	172	254TTDX4060	U209		129	254TTFL16026	E2122	✓	60
215TTFS6030	E306		60	215TTWD6031	N409A	✓	112	254TTDX4065	U436	✓	41	254TTFL16040	E2147	✓	60
215TTFS6501	E604	✓	70	215TTWR6026	N619A	✓	110	254TTDX4074	U206		129	254TTFL16076	E2117	✓	59
215TTFS6505	E657		70	215TTWR6027	N319A	✓	108	254TTDX4075	U207		129	254TTFL16077	E2142		59

Model Number/Catalog Number

MODEL NO.	CAT. NO.	STOCK	PAGE NO.	MODEL NO.	CAT. NO.	STOCK	PAGE NO.	MODEL NO.	CAT. NO.	STOCK	PAGE NO.	MODEL NO.	CAT. NO.	STOCK	PAGE NO.
254TTFNA4030	U648	✓	51	256TTDCA6076	GT0020	✓	45	256TFL4038	U355		126	284TSHFNA9001	W558	✓	75
254TTFNA6001	E220	✓	60	256TTDN14102	H187A	✓	37	256TFL4079	U757		57	284TSHFNA9005	W559		75
254TTFNA6026	E205	✓	60	256TTDN16009	U439A		41	256TFL14027	U651		49	284TSTDC6001	U772	✓	43
254TTFNA6030	E307	✓	60	256TTDN16049	U438A		41	256TFL14030	E998		49	284TSTDC6003	U292	✓	43
254TTFNA6076	E235	✓	59	256TTDX4004	U225		129	256TFL15027	H274		49	284TSTDC6001	GT0030	✓	45
254TTFNA6501	E605	✓	71	256TTDX4006	U103		122	256TFL16002	E2123	✓	60	284TSTDN16031	E793A		43
254TTFNA6503	E658		71	256TTDX4013	E786	✓	38	256TFL16020	E2148		60	284TSTDP4002	U504		134
254TTFNA6515	E481	✓	71	256TTDX4019	U104		122	256TFL16033	E2124	✓	60	284TSTDP4004	U901		39
254TTFNA6526	E620	✓	71	256TTDX4020	U501		134	256TFL16040	E2149	✓	60	284TSTDP14007	U505		131
254TTFNA6528	E673	✓	71	256TTDX4021	U102		122	256TFL16076	E2120	✓	60	284TSTFC6002	E975A	✓	60
254TTFNA6529	E482	✓	71	256TTDX4022	U224		129	256TFL16077	E2145		60	284TSTFC6006	U654A	✓	60
254TTFNA6576	E636	✓	70	256TTDX4023	U226		129	256TFNA4005	U650		51	284TSTFC6036	E999A	✓	60
254TTFNA6578	E684		70	256TTDX4024	U500		134	256TFNA4030	U653	✓	51	284TSTFCA6001	GT1027	✓	64
254TTFNA6590	E477	✓	70	256TTDX4027	E909	✓	38	256TFNA6001	E221	✓	60	284TSTFCA6003	GT1227	✓	67
254TTFNA7012	M888		138	256TTDX4032	E761	✓	38	256TFNA6026	E206	✓	60	284TSTFCA6005	GT1127	✓	64
254TTFNA7210	Y383		169	256TTDX4041	U100		122	256TFNA6030	E308	✓	60	284TSTFNA6001	E222	✓	60
254TTFNA14084	M883A		138	256TTDX4047	U101		122	256TFNA6076	E236	✓	60	284TSTFNA6501	E607	✓	71
254TTFNA14103	L412A	✓	50	256TTDX4059	U223		129	256TFNA6501	E606	✓	71	284TSTFNA6502	E660		71
254TTFNA16568	U871A	✓	68	256TTDX4063	U219		129	256TFNA6503	E659	✓	71	284TSTFPA4001	E975	✓	51
254TTFPA4005	U638		51	256TTDX4064	U218		129	256TFNA6523	E484	✓	71	284TSTFPA4005	U654		51
254TTGN1026	U951	✓	77	256TTDX4065	U221		129	256TFNA6526	E621	✓	71	284TSTGN6503	E546		83
254TTGN4030	U027	✓	81	256TTDX4075	E197		122	256TFNA6528	E674	✓	71	284TSTGN16531	U076A		83
254TTGN6507	E502		83	256TTDX4094	M811A		136	256TFNA6529	E485	✓	71	284TDC6026	U771	✓	43
254TTGN6531	E503	✓	83	256TTDX4310	M821A		136	256TFNA6576	E637	✓	70	284TDC6029	E762A	✓	43
254TTGN6576	E500		83	256TTDX4315	U439		41	256TFNA6578	E685		70	284TDC6076	U256	✓	43
254TTGN14042	C327A	✓	80	256TTDX4326	E198		122	256TFNA6596	E480	✓	70	284TDC6079	U288	✓	43
254TTGN16541	U027A	✓	83	256TTDX4328	U220		129	256TFNA7028	M893		138	284TDCA6007	GT0430	✓	124
254TTGP14013	C307A	✓	80	256TTDX4329	E199		122	256TFNA7250	Y384	✓	169	284TDCA6008	GT0530	✓	124
254TTTNA17077	S513	✓	172	256TTDX7011	M332	✓	122	256TFNA14004	U815	✓	57	284TDCA6012	GT2430	✓	132
254TTTNA18530	S518		172	256TTDX7024	H627	✓	38	256TFNA14016	M892A		138	284TDCA6013	GT2530	✓	132
256TBDX7028	Z127		141	256TTDX7074	M331	✓	122	256TFNA14084	M886A		138	284TDCA6026	GT0028	✓	45
256THEN17031	Y984		92	256TTDX7101	H187	✓	38	256TFNA14086	C256A		54	284TDCA6032	GT0428	✓	124
256THFNA8038	Y598	✓	91	256TTDX7207	Y492		170	256TFNA14101	L413A	✓	50	284TDCA6033	GT0528	✓	124
256THFNA9001	W551	✓	75	256TTDX7253	Y471		170	256TFNA16574	U872A	✓	68	284TDCA6037	GT2428	✓	132
256THFNA9026	W553	✓	75	256TTDX7263	Y457		170	256TTGN1026	U954	✓	77	284TDCA6038	GT2528	✓	132
256THFNA9076	W541		75	256TTDX7264	Y458	✓	170	256TTGN4030	U028	✓	81	284TDCA6076	GT0023	✓	45
256THFNA9101	W536		75	256TTDX7391	Y204	✓	173	256TTGN6531	E506	✓	83	284TTDN14102	H188A		38
256THFNA19033	W554	✓	75	256TTDX14039	M818A		136	256TTGN6576	E501		83	284TDP4011	U230		130
256THFNA19081	W542		75	256TTDX14087	C156A		40	256TTGN14011	C308A		80	284TDP4012	U232		130
256THTL5776	Y548	✓	89	256TTFC4076	U642	✓	51	256TTGN14044	C328A	✓	80	284TDP4022	U231		130
256THTNA7026	Y552	✓	89	256TTFC6002	U649A	✓	60	256TTGN16509	E505	✓	83	284TDP4023	U110		122
256THTNA7036	Y563	✓	89	256TTFC6006	U650A	✓	60	256TTGN16540	U028A	✓	83	284TDP4025	U108		122
256THTNA8038	Y510	✓	91	256TTFC6027	U652B	✓	60	256TTTNA18577	S566		172	284TDP4027	U502		134
256THTNA8071	Y993	✓	93	256TTFC6031	U653A	✓	60	256TTTNA18578	S516	✓	172	284TDP4029	E910		38
256TTDC6001	U770	✓	43	256TTFC6077	U642A	✓	60	256TTTNA18601	S564		172	284TDP4035	E762	✓	38
256TTDC6003	U291	✓	43	256TTFC6081	E006	✓	60	280MTFC6588	R505	✓	97	284TDP4037	U107		122
256TTDC6026	U769	✓	43	256TTFCA6001	GT1024	✓	64	280STFC6501	R506	✓	97	284TDP4043	U105		122
256TTDC6029	U290	✓	43	256TTFCA6003	GT1224	✓	67	280STFC6526	R507	✓	97	284TDP4044	U227		130
256TTDC6076	U255	✓	43	256TTFCA6005	GT1124	✓	64	280STFC6586	R502	✓	97	284TDP4045	U229		130
256TTDC6079	U285	✓	43	256TTFCA6026	GT1025	✓	64	284THEN8032	Y985		92	284TDP4047	U503		134
256TTDCA6001	GT0027	✓	45	256TTFCA6028	GT1225	✓	67	284THFNA9026	W560	✓	75	284TDP4069	U106		122
256TTDCA6007	GT0427	✓	124	256TTFCA6030	GT1125	✓	64	284THFNA9076	W548	✓	75	284TDP7072	M126	✓	130
256TTDCA6008	GT0527	✓	124	256TTFCA6076	GT1020	✓	63	284THFNA16585	W549		75	284TDP7202	Y493		170
256TTDCA6012	GT2427	✓	132	256TTFCA6078	GT1220	✓	67	284THFNA19033	W561		75	284TDP7205	Y472		170
256TTDCA6013	GT2527	✓	132	256TTFCA6080	GT1120	✓	63	284THFNA19102	W543		75	284TDP7221	Y459	✓	170
256TTDCA6026	GT0025	✓	45	256TFL4006	U351		126	284THFPA8028	Y569	✓	91	284TDP7302	M127	✓	130
256TTDCA6032	GT0425	✓	124	256TFL4010	U350		126	284THFPA8038	Y511	✓	91	284TDP7338	M333	✓	122
256TTDCA6033	GT0525	✓	124	256TFL4012	U352		126	284THFPA8086	Y395		91	284TDP7644	H628	✓	38
256TTDCA6037	GT2425	✓	132	256TFL4031	U354		126	284THTNA7026	Y553	✓	89	284TDP7692	Y215	✓	173
256TTDCA6038	GT2525	✓	132	256TFL4036	U353		126	284THTNA7036	Y567	✓	89	284TDP14009	U109A	✓	122



Index

Model Number/Catalog Number

MODEL NO.	CAT. NO.	STOCK	PAGE NO.	MODEL NO.	CAT. NO.	STOCK	PAGE NO.	MODEL NO.	CAT. NO.	STOCK	PAGE NO.	MODEL NO.	CAT. NO.	STOCK	PAGE NO.
284TTDP14044	U228A	✓	130	286TSTFC6002	E964A	✓	60	286TTFNA6030	E310	✓	60	324TTDCA6033	GT0534	✓	124
284TTDR14011	M825A		136	286TSTFC6006	E819A	✓	60	286TTFNA6076	E238	✓	60	324TTDCA6037	GT2434	✓	132
284TTDR14082	M815A		136	286TSTFC6036	E818A	✓	60	286TTFNA6526	E623	✓	71	324TTDCA6038	GT2534	✓	132
284TTFC4076	E978	✓	51	286TSTFCA6001	GT1030	✓	64	286TTFNA6527	E676	✓	71	324TTDCA6076	GT0029	✓	45
284TTFC6027	E961C	✓	60	286TSTFCA6003	GT1230	✓	67	286TTFNA6570	E491	✓	71	324TTDP4002	U240		130
284TTFC6031	E800A	✓	60	286TSTFCA6005	GT1130	✓	64	286TTFNA6576	E639	✓	71	324TTDP4004	U118		122
284TTFC6077	E978A	✓	60	286TSTFNA6001	E223	✓	60	286TTFNA6580	E695		71	324TTDP4011	U241		130
284TTFC6081	E007	✓	60	286TSTFNA6501	E608	✓	71	286TTFNA6876	E486		71	324TTDP4018	U119		122
284TTFCA6026	GT1028	✓	64	286TSTFNA6804	E490	✓	71	286TTFNA7260	Y386	✓	169	324TTDP4028	E764		39
284TTFCA6028	GT1228	✓	67	286TSTFPA4005	E819		51	286TTFNA14085	M894A		138	324TTDP4030	E787		39
284TTFCA6030	GT1128	✓	64	286TSTFPA14002	U750	✓	57	286TTFNA14106	L415A	✓	51	324TTDP4033	U239		130
284TTFCA6076	GT1023	✓	63	286TSTGN6501	E563		83	286TTFNA16572	U874A	✓	68	324TTDP4038	U510		134
284TTFCA6080	GT1123	✓	63	286TSTGN16531	U077A		83	286TTFPA4030	E817	✓	51	324TTDP4345	U116		122
284TTFNA6026	E207	✓	60	286TTDC6026	U773	✓	43	286TTFPA14011	M900A		138	324TTDP4348	U238		130
284TTFNA6030	E309	✓	60	286TTDC6029	E763A	✓	43	286TTFPA14063	M901A		138	324TTDP4349	U117		122
284TTFNA6076	E237	✓	60	286TTDC6076	U257	✓	43	286TTGN6537	E564	✓	83	324TTDP7073	M130	✓	130
284TTFNA6526	E622	✓	71	286TTDCA6007	GT0433	✓	124	286TTGN16533	U030A		83	324TTDP7320	M358	✓	122
284TTFNA6527	E675	✓	71	286TTDCA6008	GT0533	✓	124	286TTGN16577	E507		83	324TTDP7649	H636	✓	39
284TTFNA6576	E638	✓	71	286TTDCA6012	GT2433	✓	132	286TTGP4030	U030		81	324TTDP7687	Y217	✓	173
284TTFNA6580	E694		71	286TTDCA6013	GT2533	✓	132	286TTTNA18577	S522		172	324TTDP14049	U511		134
284TTFNA6837	E488	✓	71	286TTDCA6026	GT0031	✓	45	315STFC6588	F508	✓	97	324TTDR14010	M833A		136
284TTFNA6876	E483	✓	71	286TTDCA6032	GT0431	✓	124	324THFPA8028	Y571	✓	91	324TTDR14049	M830A		136
284TTFNA7240	Y385	✓	169	286TTDCA6033	GT0531	✓	124	324THFPA8038	Y513	✓	91	324TTDR14080	M823A		136
284TTFNA7508	M896		138	286TTDCA6037	GT2431	✓	132	324THFPA8086	Y583		91	324TTDR14104	M820A		136
284TTFNA14102	L414A	✓	51	286TTDCA6038	GT2531	✓	132	324THFS9026	W573	✓	75	324TTFC6027	E984B	✓	61
284TTFNA16832	U873A	✓	68	286TTDCA6076	GT0026	✓	45	324THFS9076	W562		75	324TTFC6031	E815A	✓	60
284TTFPA4028	U655		51	286TTDN14101	H189A		38	324THFS9080	W563		75	324TTFC6077	E820A	✓	60
284TTFPA4030	E800	✓	51	286TTDP4015	U114		122	324THFS19033	W574		75	324TTFC6081	E009	✓	60
284TTFPA14048	M897A		138	286TTDP4020	U236		130	324THFS9001	W571	✓	75	324TTFCA6026	GT1034	✓	64
284TTFPA14049	M890A		138	286TTDP4021	U115		122	324TSTDC6001	U776	✓	43	324TTFCA6028	GT1234	✓	67
284TTGN6533	E547	✓	83	286TTDP4024	U237		130	324TSTDC6003	U294	✓	43	324TTFCA6030	GT1134	✓	64
284TTGN6576	E504	✓	83	286TTDP4027	E911	✓	39	324TSTDC6001	GT0036	✓	45	324TTFCA6076	GT1029	✓	64
284TTGN16539	U029A		83	286TTDP4034	E763		39	324TSTDP4006	U909		38	324TTFCA6080	GT1129	✓	64
284TTGP1026	U957	✓	77	286TTDP4037	U112		122	324TSTDP4007	U513		134	324TTFPA4030	E815	✓	51
284TTGP4030	U029		81	286TTDP4041	U506		134	324TSTDP4010	U512	✓	134	324TTFPA14065	M905A		138
284TTTNA16577	S519		172	286TTDP4047	U113		122	324TSTDP4016	U445	✓	41	324TTFPA14089	M898A		138
284TTTNA17101	S567	✓	172	286TTDP4048	U233		130	324TSTDP16002	U445A	✓	41	324TTFS6026	E209	✓	61
284TTTNA18577	S569		172	286TTDP4049	U235		130	324TSTDP16032	U444A		41	324TTFS6030	E311	✓	61
284TTTNA18601	S517		172	286TTDP4067	U111		122	324TSTFC6002	E971A	✓	61	324TTFS6076	E239	✓	60
286THFNA8028	Y570	✓	91	286TTDP4074	U234		130	324TSTFC6006	E011	✓	60	324TTFS6526	E624	✓	71
286THFNA9026	W567	✓	75	286TTDP7018	M129	✓	130	324TSTFC6036	E816A	✓	61	324TTFS6527	E677	✓	71
286THFNA9076	W555		75	286TTDP7054	M128	✓	130	324TSTFCA6001	GT1033	✓	64	324TTFS6576	E640	✓	71
286THFNA19033	W568		75	286TTDP7217	Y460		170	324TSTFCA6003	GT1233	✓	67	324TTFS6577	E696		71
286THFNA19077	W556		75	286TTDP7251	Y473		170	324TSTFCA6005	GT1133	✓	64	324TTFS7290	Y387	✓	169
286THFNA19101	W550		75	286TTDP7689	Y216	✓	173	324TSTFPA14003	U830	✓	57	324TTFS14003	M904A		138
286THFPA8038	Y512	✓	91	286TTDP14042	U507		134	324TSTFS6001	E224	✓	61	324TTFS14101	L416A	✓	51
286THFPA8086	Y582		91	286TTDR14042	M826A		136	324TSTFS6005	E319		61	324TTFS16837	U875A	✓	68
286THTNA7026	Y393	✓	89	286TTDR14046	M822A		136	324TSTFS6501	E609	✓	71	324TTGP4030	U031		81
286THTNA7036	Y394	✓	89	286TTDR14081	M819A		136	324TSTFS6505	E662		71	324TTGS6529	E567	✓	83
286TSHFNA9001	W565	✓	75	286TTDR17009	M829		136	324TSTGS6501	E566		83	324TTGS16535	U031A		83
286TSTDC6001	U774	✓	43	286TTFC6027	E983B	✓	60	324TSTGS16531	U078A		83	324TTGS16577	U048A	✓	83
286TSTDC6003	U293	✓	43	286TTFC6031	E817A	✓	61	324TTDC6026	U775	✓	43	324TTTS18577	S525		172
286TSTDC6001	GT0033	✓	45	286TTFC6077	E968A	✓	60	324TTDC6029	E764A	✓	43	324TTTS18601	S523		172
286TSTDN16004	U443A	✓	41	286TTFC6081	E008	✓	60	324TTDC6076	U798	✓	43	326THFPA8038	Y514	✓	91
286TSTDN16005	U441A	✓	41	286TTFCA6026	GT1031	✓	64	324TTDCA6007	GT0436	✓	124	326THFPA8086	Y584		91
286TSTDN16033	U442A		41	286TTFCA6028	GT1231	✓	67	324TTDCA6008	GT0536	✓	124	326THFS8028	Y572	✓	91
286TSTDN16034	U440A		41	286TTFCA6030	GT1131	✓	64	324TTDCA6012	GT2436	✓	132	326THFS9026	W580	✓	76
286TSTDP4017	U902		39	286TTFCA6076	GT1026	✓	64	324TTDCA6013	GT2536	✓	132	326THFS9076	W569	✓	75
286TSTDP4022	U508	✓	134	286TTFCA6080	GT1126	✓	64	324TTDCA6026	GT0034	✓	45	326THFS19033	W581		76
286TSTDP4023	U509		134	286TTFNA6026	E208	✓	60	324TTDCA6032	GT0434	✓	124	326THFS19078	W643		75

Model Number/Catalog Number

MODEL NO.	CAT. NO.	STOCK	PAGE NO.	MODEL NO.	CAT. NO.	STOCK	PAGE NO.	MODEL NO.	CAT. NO.	STOCK	PAGE NO.	MODEL NO.	CAT. NO.	STOCK	PAGE NO.
326TSHFS9001	W577		76	326TTFCA6080	GT1132	✓	64	364TTDS4328	U520		134	365TSTFCA6001	GT1042	✓	64
326TSHFS9005	W578		76	326TTFPA4030	U659	✓	51	364TTDS14011	M841A		137	365TSTFCA6002	GT1142	✓	64
326TSHFS9036	W579		76	326TTFPA8107	L417	✓	51	364TTDS14081	M831A		136	365TSTFCA6003	GT1242	✓	67
326TSTDC6001	U778	✓	43	326TTFPA14049	M909A		138	364TTDS14104	M828A		136	365TSTFS6001	E227	✓	61
326TSTDC6001	GT0039	✓	45	326TTFS6026	E210	✓	61	364TTDS14329	U538		134	365TSTFS6002	E322		61
326TSTDP4003	U910		39	326TTFS6030	E312	✓	61	364TTFC6037	E985B	✓	61	365TSTFS6501	E612	✓	72
326TSTDP4022	U517		134	326TTFS6076	E240	✓	61	364TTFC6041	U660A	✓	61	365TSTFS6502	E665	✓	72
326TSTDP4024	U516	✓	134	326TTFS6526	E625	✓	71	364TTFC6081	E012	✓	60	365TSTFS6526	E455	✓	72
326TSTDP4036	E791	✓	39	326TTFS6527	E678	✓	71	364TTFC6087	E988A	✓	61	365TSTGS4001	U071	✓	81
326TSTDP8219	Y637	✓	134	326TTFS6576	E641	✓	71	364TTFCA6036	GT1040	✓	64	365TSTGS16503	E575		83
326TSTDP16005	U447A		41	326TTFS6580	E400		71	364TTFCA6038	GT1240	✓	67	365TSTGS16532	U081A		83
326TSTDP16032	E789A	✓	43	326TTFS9210	Y388	✓	169	364TTFCA6040	GT1140	✓	64	365TTDCA4036	E1740	✓	39
326TSTDR14034	U521		134	326TTFS14101	L417A	✓	51	364TTFCA6080	GT1135	✓	64	365TTDCA6060	U1783	✓	44
326TSTDR16034	r324	✓	43	326TTFS14103	M899A		138	364TTFCA6086	GT1035	✓	64	365TTDCA6086	U1928	✓	43
326TSTDR16035	U446A		41	326TTFS14087	M902A		138	364TTFS4040	U660	✓	51	365TTDCB6060	GT0043	✓	46
326TSTFC6002	E976A	✓	61	326TTFS16574	U876A	✓	68	364TTFS6036	E211	✓	61	365TTDCB6086	GT0038	✓	45
326TSTFC6006	E013	✓	60	326TTGP4030	U032		81	364TTFS6040	E313	✓	61	365TTDS4041	E767		39
326TSTFC6036	E801A	✓	61	326TTGS6532	E570	✓	83	364TTFS6536	E626	✓	71	365TTDS4328	M842A		137
326TSTFCA6001	GT1036	✓	64	326TTGS6578	E565	✓	83	364TTFS6537	E679	✓	71	365TTDS7383	Y209		173
326TSTFCA6003	GT1236	✓	67	326TTGS16539	U032A		83	364TTFS8101	L420	✓	51	365TTDS14009	M845A		137
326TSTFCA6005	GT1136	✓	64	326TTTS18577	S528		172	364TTFS9234	Y389	✓	169	365TTDS14082	M835A		136
326TSTFS6001	E225	✓	61	364THFS8036	Y573	✓	91	364TTFS14003	M912A		139	365TTDS14101	M832A		136
326TSTFS6005	E320		61	364THFS8046	Y515	✓	91	364TTFS14058	M913A		139	365TTDS16064	E767A		44
326TSTFS6501	E610	✓	71	364THFS8391	Y585		91	364TTFS14087	M906A		138	365TTDS16067	E766A		43
326TSTFS6502	E663		71	364THFS9036	W587	✓	76	364TTFS16083	E241A	✓	61	365TTFC6037	E957A	✓	61
326TSTFS6536	E453		71	364THFS19033	W588		76	364TTFS16558	H877A	✓	68	365TTFC6041	E805A	✓	61
326TSTGP4001	U069	✓	81	364THFS19077	W639		75	364TTFS16584	E642A	✓	71	365TTFC6081	E014	✓	60
326TSTGS6501	E569		83	364THFS19087	W575A		75	364TTFS16585	E401A		71	365TTFC6087	E993A	✓	61
326TSTGS16532	U079A		83	364TSHFS9001	W584	✓	76	364TTGS1036	U969	✓	77	365TTFCA6036	GT1043	✓	64
326TTDC6026	U777	✓	43	364TSHFS9026	W586		76	364TTGS4040	U033		81	365TTFCA6038	GT1243	✓	67
326TTDC6029	E765A	✓	43	364TSTDC4026	E768	✓	39	364TTGS16536	E573A	✓	83	365TTFCA6040	GT1143	✓	64
326TTDC6076	U799	✓	43	364TSTDC4A026	E1768	✓	39	364TTGS16537	U033A		83	365TTFCA6080	GT1138	✓	64
326TTDCA6026	GT0037	✓	45	364TSTDC6001	U1782	✓	44	364TTGS16577	E568A	✓	83	365TTFCA6086	GT1038	✓	64
326TTDCA6032	GT0437	✓	124	364TSTDCB6001	GT0042	✓	46	365THFS8036	Y574	✓	91	365TTFS4040	E805	✓	52
326TTDCA6033	GT0537	✓	124	364TSTDS4001	E714	✓	39	365THFS8046	Y516	✓	91	365TTFS7923	M916A		139
326TTDCA6037	GT2437	✓	132	364TSTDS4024	U523		134	365THFS8380	Y586		91	365TTFS6036	E212	✓	61
326TTDCA6038	GT2537	✓	132	364TSTDS4025	U522	✓	135	365THFS9036	W594	✓	76	365TTFS6040	E315	✓	61
326TTDCA6076	GT0032	✓	45	364TSTDS4332	U518	✓	134	365THFS9044	W595	✓	76	365TTFS6536	E627	✓	72
326TTDP4032	U243		130	364TSTDS4337	U519		134	365THFS19077	W640		76	365TTFS6537	E680		72
326TTDP4046	E790		39	364TSTFC6002	E960A	✓	61	365THFS19086	W582A	✓	76	365TTFS8115	L425	✓	51
326TTDP4048	E765	✓	39	364TSTFC6006	E015	✓	60	365THFS19101	W576		75	365TTFS9230	Y390	✓	169
326TTDP4326	U121		122	364TSTFC6026	E802A	✓	61	365TSHFS9001	W591	✓	76	365TTFS14060	M917A		139
326TTDP4329	U120		122	364TSTFCA6001	GT1039	✓	64	365TSHFS19002	W592		76	365TTFS14084	M910A		138
326TTDP4340	U242		130	364TSTFCA6003	GT1239	✓	67	365TSHFS19034	W593A		76	365TTFS16083	E242A	✓	61
326TTDP4344	U515		134	364TSTFCA6005	GT1139	✓	64	365TSTDC4026	E1782	✓	39	365TTFS16591	E643A	✓	71
326TTDP4345	U514		134	364TSTFS6001	E226	✓	61	365TSTDC6001	U1784	✓	44	365TTFS16592	E402A		71
326TTDP7330	M131	✓	130	364TSTFS6005	E321		61	365TSTDCB6001	GT0045	✓	46	365TTFS16827	U878A	✓	68
326TTDP7697	Y218	✓	173	364TSTFS6501	E611	✓	71	365TSTDS4025	U526	✓	135	365TTFS17102	M907		138
326TTDR14010	M837A		137	364TSTFS6505	E664		71	365TSTDS4303	U527	✓	135	365TTGS1036	U972	✓	77
326TTDR14034	M834A		136	364TSTFS6526	E454		71	365TSTDS4332	U524	✓	135	365TTGS4040	U034		81
326TTDR14103	M824A		136	364TSTGS6506	E572		83	365TSTDS4347	U525		135	365TTGS16540	E576A	✓	83
326TTDR14105	H191A		38	364TSTGS16531	U080A		83	365TSTDS6074	U450A		41	365TTGS16542	U034A		83
326TTFC6027	E962B	✓	61	364TTDCA4036	E739	✓	39	365TSTDS16005	U451A		41	365TTGS16577	E571		83
326TTFC6031	U659A	✓	61	364TTDCA4036	E1739	✓	39	365TSTDS16008	U449A		41	404THFS8092	Y587		91
326TTFC6077	E966A	✓	61	364TTDCA6060	U1779	✓	43	365TSTDS16041	E782C	✓	44	404THFS9086	W589		76
326TTFC6081	E010	✓	60	364TTDCA6086	U1927	✓	43	365TSTDS16042	E768C	✓	43	404THFS9101	W583		76
326TTFCA6026	GT1037	✓	64	364TTDCB6060	GT0040	✓	45	365TSTDS16044	U448A		41	404TSTDC6001	GT0048	✓	46
326TTFCA6028	GT1237	✓	67	364TTDCB6086	GT0035	✓	45	365TSTFC6003	E991A	✓	61	404TSTDS4001	E754	✓	39
326TTFCA6030	GT1137	✓	64	364TTDR14032	M838A		137	365TSTFC6006	E016	✓	60	404TSTDS4017	U530	✓	135
326TTFCA6076	GT1032	✓	64	364TTDS4040	E766		39	365TSTFC6026	E804A	✓	61	404TSTDS4332	U528	✓	135



Index

Model Number/Catalog Number

MODEL NO.	CAT. NO.	STOCK	PAGE NO.	MODEL NO.	CAT. NO.	STOCK	PAGE NO.	MODEL NO.	CAT. NO.	STOCK	PAGE NO.	MODEL NO.	CAT. NO.	STOCK	PAGE NO.
404TSTDS4333	U529	✓	135	405TTDS4036	E742	✓	39	444TSTGN16502	U073A		84	445STFC6005	GT1151	✓	65
404TSTDS6001	U250	✓	44	405TTDS4049	U904		39	444TSTGN16531	U083A		84	445STFC6005	E812	✓	52
404TSTDS6327	U452A		41	405TTDS4376	M843A		137	444TTDC16077	GT0047	✓	46	445STFC6001	E230	✓	62
404TSTDS7623	Y651		135	405TTDS6060	E923	✓	44	444TTDC6060	GT0052	✓	46	445STFC6026	E811A	✓	62
404TSTDS14008	U531		135	405TTDS7124	M840		137	444TTDS14003	M857A		137	445STFC6501	E615	✓	72
404TSTDS16006	U453A	✓	41	405TTDS7697	Y211	✓	173	444TTDS14057	M854A		137	445STFC6502	E495		72
404TSTDS16036	E780A	✓	44	405TTDS14003	M853A		137	444TTDS14086	M847A		137	445STFC6505	E449	✓	72
404TTDC6060	GT0046	✓	46	405TTDS14067	M850A		137	444TTDS14101	M844A		137	445STFC6506	E496		72
404TTDC6086	GT0041	✓	45	405TTDS16060	U904A		44	444TTDS16043	U911A		44	445STFC6526	E458	✓	72
404TTDS4042	U903		39	405TTDS16081	U271	✓	44	444TTDS16077	U272	✓	44	445STFC6528	E459	✓	72
404TTDS4086	E748	✓	39	405TTFC6036	GT1046	✓	65	444TTDS4036	E743	✓	39	445STFC6004	E342	✓	62
404TTDS4359	M846A		137	405TTFC6038	GT1246	✓	67	444TTDS4069	U911		39	445STFC6033	E813A		84
404TTDS6060	E922	✓	44	405TTFC6040	GT1146	✓	65	444TTDS6060	E924	✓	44	445STGN16505	E584		84
404TTDS6086	U270	✓	43	405TTFC6080	GT1144	✓	64	444TTDS8699	Y212	✓	173	445STGN16506	U075A		84
404TTDS7387	Y210	✓	173	405TTFC6086	GT1044	✓	64	444TTFC6036	GT1049	✓	65	445STGN16531	U084A		84
404TTDS14005	M849A		137	405TTF6036	E213	✓	61	444TTF6044	GT1149	✓	65	445TDC6060	GT0055	✓	46
404TTDS14081	M839A		137	405TTF6040	E314	✓	61	444TTF6080	GT1147	✓	65	445TDC16076	GT0050	✓	46
404TTDS14102	M836A		136	405TTF6086	E244	✓	61	444TTF6086	GT1047	✓	65	445TDS4037	E745		39
404TTDS16055	U903A		44	405TTF6536	E628	✓	72	444TTFN6086	E328	✓	61	445TDS4070	U912		39
404TTFC6080	GT1141	✓	64	405TTF6538	E681	✓	72	444TTFN14044	M925A		139	445TDS6060	E925	✓	44
404TTFC6086	GT1041	✓	64	405TTF6586	E645	✓	72	444TTFN14080	M922A		139	445TDS7121	M848		137
404TTFS4086	E803	✓	51	405TTF6587	E404		72	444TTFN16549	U880A	✓	68	445TDS9477	Y213		173
404TTFS6086	E243	✓	61	405TTF67297	Y391		169	444TTFN16581	E646A	✓	72	445TDS17084	M855A		137
404TTFS6586	E644	✓	72	405TTF67612	M920		139	444TTFN16582	E405A		72	445TDS14003	M861A		137
404TTFS6592	E403		72	405TTF68114	L427	✓	51	444TTFN16577	E327		72	445TDS14062	M862A		137
404TTFS8102	L426	✓	51	405TTF68114	L427	✓	51	444TTF6036	E214	✓	61	445TDS14063	M858A		137
404TTFS14088	M914A		139	405TTF68114	M921A		139	444TTF6044	E214	✓	61	445TDS14087	M851A		137
404TTGS4087	U089	✓	81	405TTF6834	M918A		139	444TTF6044	E316		61	445TDS16041	U912A		44
404TTGS6588	E574		83	405TTF6834	U879A	✓	68	444TTF6536	E629	✓	72	445TDS16076	U273	✓	44
405THFS8036	Y575	✓	92	405TTGS1086	U973	✓	77	444TTF6540	E697		72	445TFC6036	GT1052	✓	65
405THFS8046	Y517	✓	92	405TTGS4040	U035		81	444TTF67321	M924		139	445TFC6037	GT1152	✓	65
405THFS8378	Y588	✓	91	405TTGS4046	U097	✓	77	444TTF67262	Y392		169	445TFC6080	GT1150	✓	65
405THFS9036	W600	✓	76	405TTGS4087	U088	✓	81	444TTF67403	M919		139	445TFC6086	GT1050	✓	65
405THFS9040	W601	✓	76	405TTGS6548	E594	✓	84	444TTF68106	L428		52	445TFC6086	GT1050	✓	65
405THFS9086	W596		76	405TTGS6589	E577		83	444TTGN16532	E582A	✓	84	445TFC6028	U669A		62
405THFS9101	W590		76	405TTGS16539	U035A		84	444TTGN16533	U036A		84	445TFC6036	E215	✓	62
405THFS9001	W598	✓	76	444THFN8036	Y576	✓	92	444TTGN16580	E580A	✓	84	445TFC6037	E317		62
405THFS9026	W599		76	444THFN8046	Y518	✓	92	444TTGS4042	U036		81	445TFC6038	E247	✓	62
405STDC6007	GT0051	✓	46	444THFN8384	Y589	✓	92	445THFN8036	Y577	✓	92	445TFC6039	E326		62
405STDS4001	E755	✓	39	444THFN9081	W636		76	445THFN8040	Y578	✓	92	445TFC6040	E287		62
405STDS4006	U534	✓	135	444THFS9036	W606		76	445THFN8046	Y519	✓	92	445TFC6086	E246	✓	61
405STDS4332	U532	✓	135	444THFS9040	W607		76	445THFN8050	Y520	✓	92	445TFC6087	E289		62
405STDS4333	U533		135	444THFS9101	W597		76	445THFN9036	W612	✓	76	445TFC6536	E630	✓	72
405STDS6007	U251	✓	44	444SHFN19002	W604A		76	445THFN9037	W613		76	445TFC6537	E682		72
405STDS16005	U455A		41	444STDC16003	GT0054	✓	46	445THFN9038	W618		76	445TFC6538	E631	✓	72
405STDS16038	E781A	✓	44	444STDS4001	E756	✓	39	445THFN9086	W608		76	445TFC6540	E450		72
405STDS16039	U454A		41	444STDS4010	U536	✓	135	445THFN9087	W614		76	445TFC6586	E647	✓	72
405STFC6001	GT1045	✓	65	444STDS4332	U535	✓	135	445THFN9102	W609		76	445TFC6587	E448	✓	72
405STFC6003	GT1245	✓	67	444STDS16034	U456A		41	445THFN9106	W603		76	445TFC6590	E406		72
405STFC6005	GT1145	✓	65	444STDS16038	E792A	✓	44	445THFN9033	W641		76	445TFC6591	E407		72
405STFS6001	E228	✓	61	444STDS16003	U252	✓	44	445THFN9034	W642	✓	76	445TFC6591	E407		72
405STFS6005	E323		61	444STFC6001	GT1048	✓	65	445SHFN9001	W610		76	445TFC6804	L452	✓	52
405STFS6501	E613	✓	72	444STFC16002	GT1148	✓	65	445SHFN9005	W616		76	445TFC8102	L440		52
405STFS6502	E493		72	444STFC16033	E810A	✓	61	445SHFN9026	W611	✓	76	445TFC8115	L429	✓	52
405STFS6526	E456	✓	72	444STFC4001	E992	✓	52	445SHFN9028	W617		76	445TFC14003	M928A		139
405STFS16033	E808A	✓	61	444STFS4026	E810	✓	52	445STDS4001	E757	✓	39	445TFC14086	M926A		139
405STGS6503	E578		84	444STFS6001	E229	✓	61	445STDS4332	U537	✓	135	445TFC14326	M929A		139
405STGS16531	U082A		84	444STFS6501	E614	✓	72	445STDS14007	U539	✓	135	445TFC14330	M933A		139
405TTDC6060	GT0049	✓	46	444STFS6505	E494		72	445STDS14051	U540	✓	135	445TFC16852	U882A		68
405TTDC16081	GT0044	✓	46	444STFS6526	E457	✓	72	445STDS16038	U400A	✓	44	445TFC16866	U881A	✓	68
				444STFS16002	E324		61	445STFC6001	GT1051	✓	65				

Model Number/Catalog Number

MODEL NO.	CAT. NO.	STOCK	PAGE NO.	MODEL NO.	CAT. NO.	STOCK	PAGE NO.	MODEL NO.	CAT. NO.	STOCK	PAGE NO.	MODEL NO.	CAT. NO.	STOCK	PAGE NO.
445TTGN4030	U037		81	449TTDC16076	GT0056		46	976B399AAP9	A950	✓	200	KIT 180TDFR	A630	✓	192
445TTGN4045	U038		81	449TTDN7086	H820		39	976B399AAP12	A951	✓	200	KIT 180U	1814T	✓	204
445TTGN6538	E588		84	449TTDN14078	H821A		39	976B399AAP13	A952	✓	200	KIT 182SB	182A	✓	204
445TTGN6542	E585		84	449TTDN16076	U275	✓	44	976B399ABP6	A953	✓	200	KIT 184SB	184A	✓	204
445TTGN6597	E583		84	449TTDN16077	U790		44	976B399ABP9	A954	✓	200	KIT 197	A197	✓	199
445TTGN16543	U038A		84	449TTFC6080	GT1156		65	976B399ABP10	A955	✓	200	KIT 198	A198	✓	199
445TTGN16544	U037A		84	449TTFC6088	GT1056		65	KIT 391-200-01	A000	✓	200	KIT 199	A199	✓	199
445TTGN16588	U090A		84	449TTFS6037	E277		62	KIT 391-200-02	A001	✓	200	KIT 202	A202	✓	199
447TSTDN7001	H178	✓	39,132	449TTFS6038	E276		62	KIT 3BRK1	A306	✓	194	KIT 201	A201	✓	199
447TSTDN7003	H193	✓	39,132	449TTFS6065	E292		62	KIT 3BRK3	A301	✓	194	KIT 190TCDW	A606	✓	190
447TSTDN7005	H817	✓	39,132	449TTFS6087	E283		62	KIT 3BRK3A	A297	✓	194	KIT 190TCD-WD	A161		190
447TSTDN7026	H812	✓	39,132	449TTFS6088	E282	✓	62	KIT 6BRK1	A307	✓	194	KIT 190TCFL	A204	✓	191
447TSTDN7027	H813	✓	39,132	449TTFS6390	E284		62	KIT 6BRK3	A302	✓	194	KIT 190TCFS	A206	✓	191
447TSTDN7028	H814	✓	39,132	449TTFS6527	E772		73	KIT 6BRK3A	A298	✓	194	KIT 190TCFS-841	A183	✓	192
447TSTDN16004	U785	✓	44	449TTFS6528	E771	✓	72	KIT 10BRK	A303	✓	194	KIT 190TCFW	A609	✓	191
447TSTDN16007	U788	✓	44	449TTFS6530	E770	✓	72	KIT 10BRKA	A299	✓	194	KIT 190TCF-WD	A171		191
447TSTDN16008	U791	✓	44	449TTFS6536	E692	✓	73	KIT 21TEBC	A692	✓	201	KIT 190TCN	A646	✓	191
447TSTFC6005	GT1154	✓	65	449TTFS6537	E691	✓	73	KIT 25TEBCNA	A691	✓	201	KIT 190R	A721	✓	201
447TSTFC16004	GT1054	✓	65	449TTFS6538	E690	✓	72	KIT 28TEBCNA	A701	✓	201	KIT 190U	1918T	✓	204
447TTDC16077	GT0053	✓	46	449TTFS6540	E854	✓	72	KIT 32TEBC	A695	✓	201	KIT 193SB	193A	✓	204
447TTDN14087	H822A		39	449TTFS6564	E856	✓	72	KIT 36TEBC	A696	✓	201	KIT 195SB	195A	✓	204
447TTDN16041	U789		44	449TTFS6577	E774		72	KIT 40TEBC	A697	✓	201	KIT 234	A234	✓	199
447TTDN16046	U786	✓	44	449TTFS6578	E773	✓	72	KIT 44TEBC-313	A698	✓	201	KIT 240	A240	✓	195
447TTDN16077	U274	✓	44	449TTFS6582	E408		72	KIT 44TEBC-316	A699	✓	201	KIT 241	A241	✓	195
447TFC6038	GT1055	✓	65	449TTFS6587	E688		72	KIT 44TEBC-318	A700	✓	201	KIT 242	A242	✓	195
447TFC6039	GT1155	✓	65	449TTFS6598	E687	✓	72	KIT 56CDR-1	A435	✓	190	KIT 243	A243	✓	197
447TFC6080	GT1153	✓	65	449TTFS7109	M931		139	KIT 56CFR-1	A437	✓	191	KIT 244	A244	✓	197
447TFC6087	GT1053	✓	65	449TTFS8027	L463	✓	52	KIT 56 EXPR BOX	A800	✓	199	KIT 245	A245	✓	197
449THFS8036	Y579		92	449TTFS8028	L455		52	KIT 100	A100	✓	197	KIT 247	A247	✓	199
449THFS8037	Y580		92	449TTFS8036	L467	✓	52	KIT 103	A103	✓	203	KIT 248	A248	✓	199
449THFS8046	Y531	✓	92	449TTFS8037	L462	✓	52	KIT 104	A104	✓	196	KIT 249	A249	✓	196
449THFS8047	Y532	✓	92	449TTFS8038	L454	✓	52	KIT 105	A105	✓	198	KIT 250	A250	✓	196
449THFS8048	Y533	✓	92	449TTFS8076	L465		52	KIT 106	A106	✓	198	KIT 250-320 TERM BLK	A1001	✓	193
449THFS9027	W632		76	449TTFS8077	L457		52	KIT 107-637	A107	✓	195	KIT 250CB	A722	✓	199
449THFS9028	W626		76	449TTFS8086	L464	✓	52	KIT 109	A109	✓	203	KIT 250R	A725	✓	201
449THFS9030	W619		76	449TTFS8087	L456	✓	52	KIT 110	A110	✓	196	KIT 250RFNA	A724	✓	201
449THFS9036	W635		76	449TTFS8110	L449	✓	52	KIT 111	A111	✓	197	KIT 250RFPA	A723	✓	201
449THFS9088	W622		76	449TTFS8111	L442		52	KIT 112	A112	✓	196	KIT 250TCD-WD	A163		190
449THFS9101	W615		76	449TTFS14043	L469A	✓	52	KIT 113	A113	✓	196	KIT 250TCD2-WD	A162		190
449THFS19079	W630		76	449TTFS16094	E814A		62	KIT 114	A114	✓	196	KIT 250TCDX	A612	✓	190
449THFS19092	W621		76	449TTFS16333	E293		62	KIT 116	A116	✓	203	KIT 250TCF-WD	A173		191
449TSHFS9001	W634		76	449TTFS16334	E291		62	KIT 140CB	A715	✓	201	KIT 250TCF2-WD	A172		191
449TSHFS9003	W624		76	449TTFS16534	E345		73	KIT 140TCDR-1	A436	✓	190	KIT 250TCFL	A209	✓	191
449TSTDN7001	H818	✓	39,132	449TTFS16553	E776		73	KIT 140TCFR-1	A438	✓	191	KIT 250TCFL-R	A1209	✓	191
449TSTDN7027	H816		39,132	449TTFS18105	L471		52	KIT 143SB	143A	✓	204	KIT 250TCFNA	A284	✓	191
449TSTDN14005	H819A	✓	39,132	449TTGS7036	H504		84	KIT 143TCFN	A603	✓	191	KIT 250TCFNA-841	A184	✓	192
449TSTDN14033	H815A		39,132	449TTGS7037	H503		84	KIT 143TCFN-841	A181	✓	192	KIT 250TCFP	A601	✓	191
449TSTDN16003	U793	✓	44	449TTGS7068	H502		84	KIT 145SB	145A	✓	204	KIT 250TCFPA	A239	✓	191
449TSTDN16004	U795	✓	44	449TTGS16537	E591		84	KIT 145TCFN	A655	✓	191	KIT 250TDFNA	A648	✓	192
449TSTDN16005	U797	✓	44	449TTGS16585	U091A		84	KIT 145TCFN-841	A262	✓	192	KIT 250TDFPA	A647	✓	192
449TSTGS14003	E595		84	505UTDS805	M852		137	KIT 180/210CB	A720	✓	199	KIT 250U	25U21T	✓	204
449TSTFS6001	E273		62	505UTDS819	M856		137	KIT 180-190 TERM BLK	A1000	✓	193	KIT 251	A251	✓	196
449TSTFS6002	E272		62	505UTDS1584	Y219		173	KIT 180CF4.5-1	A645	✓	191	KIT 252	A252	✓	196
449TSTFS6003	E271		62	505UTDS1590	Y220		173	KIT 180CF8.5-1	A644	✓	191	KIT 253	A253	✓	196
449TSTFS6501	E769	✓	73	505UTDS3999	M863A		137	KIT 180R	A718	✓	201	KIT 254	A254	✓	196
449TSTFS6502	E698	✓	73	505UTDS5820	M860		137	KIT 180TCD-WD	A160		190	KIT 254SB	254B2	✓	204
449TSTFS6503	E699	✓	72	505UTDS14077	M859A		137	KIT 180TCF-WD	A170		191	KIT 256	A256	✓	198
449TSTFS8001	L466	✓	52	5011LSTFS16031	E364		73	KIT 180TCN4.5	A640	✓	191	KIT 256SB	256B2	✓	204
449TSTFS8002	L459	✓	52	5011LSTFS16033	E366		73	KIT 180TCN8.5	A641	✓	191	KIT 257	A257	✓	198
449TSTFS14007	L451A	✓	52	5013LSTFS6595	E363		73	KIT 180TCFS-841	A182	✓	192	KIT 258	A258	✓	198



Index

Model Number/Catalog Number

MODEL NO.	CAT. NO.	STOCK	PAGE NO.	MODEL NO.	CAT. NO.	STOCK	PAGE NO.	MODEL NO.	CAT. NO.	STOCK	PAGE NO.	MODEL NO.	CAT. NO.	STOCK	PAGE NO.
KIT 259	A259	✓	197	KIT 360TCFS	A197	✓	191	KIT 447/9TCD-WD	A419	✓	190	KIT 175986	A555	✓	193
KIT 261	A261	✓	199	KIT 360TCFSR	A395	✓	191	KIT 447/9 TERM BLK	A1004	✓	193	KIT 175987	A582	✓	193
KIT 277	A277	✓	197	KIT 360TCFSR-841	A188	✓	192	KIT 447/9TCF-WD	A429	✓	191	KIT 175988	A556	✓	193
KIT 278	A278	✓	197	KIT 360TDFC	A637	✓	192	KIT 447/9TCF2-WD	A428	✓	191	KIT 175989	A583	✓	193
KIT 279	A279	✓	195	KIT 360TSCDS	A199	✓	190	KIT 447SB	447B2	✓	204	KIT 175990	A557	✓	193
KIT 280	A280	✓	195	KIT 360TSCFSR	A396	✓	191	KIT 449BBFS	A761	✓	201	KIT 175991	A584	✓	193
KIT 280CB	A729	✓	199	KIT 360TSCFSR-841	A189	✓	192	KIT 449BBFS-319	A788	✓	201	KIT 175994	A559	✓	193
KIT 280R	A728	✓	201	KIT 360U	36U32T	✓	204	KIT 449BBFS-322	A787	✓	201	KIT 175995	A580	✓	193
KIT 280RFN	A727	✓	201	KIT 364SB	364B2	✓	204	KIT 449BRFS	A758	✓	201	KIT 631475	A561	✓	193
KIT 280RFNA	A731	✓	201	KIT 365SB	365B2	✓	204	KIT 449SB	449B2	✓	204	KIT 635115	A569	✓	193
KIT 280RFPA	A726	✓	201	KIT 370-3	A371	✓	197	KIT 449TCFS	A623	✓	191	KIT 711485	A562	✓	193
KIT 280TCD-WD	A165	190		KIT 370-4	A372	✓	197	KIT 449TSCFS-1	A624	✓	191	KIT 715130	A570	✓	193
KIT 280TCD2-WD	A164	190		KIT 370-5	A373	✓	197	KIT 449TSCFS-2	A625	✓	191	KIT 805165	A571	✓	193
KIT 280TCD2C	A287	✓	190	KIT 370-7.5	A375	✓	197	KIT 649R	A649	✓	192	KIT 905165	A572	✓	193
KIT 280TCDCA	A1287	✓	190	KIT 370-10	A376	✓	197	KIT 650R	A650	✓	192	KIT 1005195	A573	✓	193
KIT 280TCDP	A610	✓	190	KIT 370-15	A378	✓	197	KIT 651R	A651	✓	192	KIT 1125195	A574	✓	193
KIT 280TCF-WD	A175	191		KIT 370-17.5	A379	✓	197	KIT 903	A903	✓	194	KIT 1325265	A575	✓	193
KIT 280TCF2-WD	A174	191		KIT 370-20	A380	✓	197	KIT 904	A904	✓	194	KIT 1605300	A576	✓	193
KIT 280TCFN	A615	✓	191	KIT 370-25	A381	✓	197	KIT 905	A905	✓	194	KIT 1805300	A577	✓	193
KIT 280TCFN-841	A185	✓	192	KIT 370-30	A382	✓	197	KIT 906	A906	✓	194	KIT 2005350	A578	✓	193
KIT 280TCFNA	A618	✓	191	KIT 400-445 TERM BLK	A1003	✓	193	KIT 907	A907	✓	194	KIT 2255400	A579	✓	193
KIT 280TCFNA-841	A186	✓	192	KIT 400BRFS-316	A756	✓	201	KIT 908	A908	✓	194	KIT 8014100	A563	✓	193
KIT 280TCFP	A611	✓	191	KIT 400TCD-WD	A414	✓	190	KIT 909	A909	✓	194	KIT 9014115	A564	✓	193
KIT 280TCFPA	A617	✓	191	KIT 400TCD2-WD	A415	✓	190	KIT 910	A910	✓	194	KIT 10014130	A565	✓	193
KIT 280TDFNA	A656	✓	192	KIT 400TCDS	A202	✓	190	KIT 911	A911	✓	194	KIT 11194130	A566	✓	193
KIT 280TDFP	A631	✓	192	KIT 400TCFS	A203	✓	191	KIT 175058	A626	✓	190	KIT 13194165	A567	✓	193
KIT 280U	28U25T	✓	204	KIT 400TCFS-841	A190	✓	192	KIT 175059	A627	✓	190	KIT 16014195	A568	✓	193
KIT 281	A281	✓	195	KIT 400TCF-WD	A425	✓	191	KIT 175060	A628	✓	190	KIT A02H1024-BC LED	A668	✓	202
KIT 282	A282	✓	195	KIT 400TCF2-WD	A424	✓	191	KIT 175061	A654	✓	191	KIT A02H2048-BC LED	A669	✓	202
KIT 283	A283	✓	195	KIT 400TDFS	A634	✓	192	KIT 175066	A602	✓	190	KIT A688-10	A688-10	✓	202
KIT 284SB	284B2	✓	204	KIT 400TSCDS	A225	✓	190	KIT 175067	A622	✓	190	KIT A688-20	A688-20	✓	202
KIT 286SB	286B2	✓	204	KIT 400TSCFS	A226	✓	191	KIT 175068	A652	✓	191	KIT A688-25	A688-25	✓	202
KIT 308	A308	✓	195	KIT 400TSCFS-841	A191	✓	192	KIT 175076	A665	✓	191	KIT A688-30	A688-30	✓	202
KIT 311	A311	✓	199	KIT 400U	40U36T	✓	204	KIT 175077	A642	✓	191	KIT A688-50	A688-50	✓	202
KIT 320CB	A730	✓	199	KIT 404SB	404B2	✓	204	KIT 175181	A600	✓	190	KIT A688-60	A688-60	✓	202
KIT 320RFPA	A733	✓	201	KIT 405SB	405B2	✓	204	KIT 175191	A653	✓	191	KIT A688-100	A688-100	✓	202
KIT 320TCD-WD	A167	190		KIT 440-7.5	A445	✓	197	KIT 175296	A643	✓	191	KIT A690-15	A690-15	✓	202
KIT 320TCD2-WD	A166	190		KIT 440-10	A446	✓	197	KIT 175614	A662	✓	199	KIT BM6BRK	A312	✓	194
KIT 320TCDP	A613	✓	190	KIT 440BRFN	A760	✓	201	KIT 175601	A629	✓	190	KIT BM6BRK115	A317	✓	194
KIT 320TCF-WD	A177	191		KIT 440BRFN	A759	✓	201	KIT 175691	A666	✓	191	KIT BM6BRK575	A315	✓	194
KIT 320TCF2-WD	A176	191		KIT 440BRFS-318	A757	✓	201	KIT 175810	A554A	✓	193	KIT BM10BRK	A313	✓	194
KIT 320TCFP	A614	✓	191	KIT 440TCDS	A228	✓	190	KIT 175811	A555A	✓	193	KIT BM10BRK115	A318	✓	194
KIT 320TCFPA	A619	✓	191	KIT 440TCFN	A620	✓	191	KIT 175812	A556A	✓	193	KIT BM10BRK575	A316	✓	194
KIT 320TCFS	A194	✓	191	KIT 440TCFN-841	A194	✓	192	KIT 175817	A581A	✓	193	KIT BRK-3 115/230	A1306	✓	194
KIT 320TCFS-841	A187	✓	192	KIT 440TCFS	A229	✓	191	KIT 175818	A582A	✓	193	KIT BRK-3 208-230/460	A1301	✓	194
KIT 320TDFP	A632	✓	192	KIT 440TCFS-841	A192	✓	192	KIT 175819	A583A	✓	193	KIT BRK-3 575	A1297	✓	194
KIT 320TDFPA	A657	✓	192	KIT 440TSCDN	A293	✓	190	KIT 175827	A555B	✓	193	KIT BRK-6 115/230	A1307	✓	194
KIT 320TDFS	A658	✓	192	KIT 440TSCDS	A231	✓	190	KIT 175832	A582B	✓	193	KIT BRK-6 208-230/460	A1302	✓	194
KIT 320U	32U28T	✓	204	KIT 440TSCFN	A621	✓	191	KIT 175835	A594	✓	193	KIT BRK-6 575	A1298	✓	194
KIT 324SB	324B2	✓	204	KIT 440TSCFN-841	A195	✓	192	KIT 175836	A596	✓	193	KIT BRK-10 208-230/460	A1303	✓	194
KIT 326SB	326B2	✓	204	KIT 440TSCFS	A232	✓	191	KIT 175837	A598	✓	193	KIT BRK-10 575	A1299	✓	194
KIT 364-445CB	A119	✓	199	KIT 440TSCFS-841	A193	✓	192	KIT 175844	A667	✓	191	KIT ENCBOX	A801	✓	202
KIT 360BRFSR-314	A755	✓	201	KIT 440U	44U40T	✓	204	KIT 175890	A558	✓	193	KIT EP2400	A496	✓	203
KIT 360 TERM BLK	A1002	✓	193	KIT 444SB	444B2	✓	204	KIT 175900	A585	✓	193	KIT EPC260 2048	A686	✓	202
KIT 360TCD-WD	A169	190		KIT 4445TCD-WD	A417	✓	190	KIT 175901	A586	✓	193	KIT HS201024-NV	A687	✓	202
KIT 360TCD2-WD	A168	190		KIT 4445TCD2-WD	A416	✓	190	KIT 175902	A587	✓	193	KIT HS25A1024-NV	A746	✓	202
KIT 360TCDS	A196	✓	190	KIT 4445TCF-WD	A427	✓	191	KIT 175903	A588	✓	193	KIT HS25A2048-NV	A747	✓	202
KIT 360TCF-WD	A179	191		KIT 4445TCF2-WD	A426	✓	191	KIT 175984	A554	✓	193	KIT HS351024-BC	A775	✓	202
KIT 360TCF2-WD	A178	191		KIT 445SB	445B2	✓	204	KIT 175985	A581	✓	193	KIT HS351024-FC	A774	✓	202

Model Number/Catalog Number

MODEL NO.	CAT. NO.	STOCK	PAGE NO.	MODEL NO.	CAT. NO.	STOCK	PAGE NO.	MODEL NO.	CAT. NO.	STOCK	PAGE NO.	MODEL NO.	CAT. NO.	STOCK	PAGE NO.
KIT HS351024-NV	A772	✓	202	KIT SL561024-182NV	A789	✓	202								
KIT HS352048-BC	A778	✓	202	KIT SL851024-184NV	A790	✓	202								
KIT HS352048-FC	A777	✓	202	KIT SL851024-190NV	A791	✓	202								
KIT HS352048-NV	A776	✓	202	KIT SL851024-250NV	A792	✓	202								
KIT HS35A1024-BC	A738	✓	202	KIT STUBSHAFT 1IN	A807	✓	202								
KIT HS35A1024-FC	A737	✓	202	KIT VRT87BRK	A157	✓	194								
KIT HS35A1024-NV	A736	✓	202												
KIT HS35A2048-FC	A740	✓	202												
KIT HS35A2048-NV	A739	✓	202												
KIT HS35B1024-BC	A781	✓	202												
KIT HS35B1024-FC	A783	✓	202												
KIT HS35B1024-NV	A779	✓	202												
KIT HS35B2048-BC	A782	✓	202												
KIT HS35B2048-FC	A784	✓	202												
KIT HS35B2048-NV	A780	✓	202												
KIT HS35M1024	A742	✓	202												
KIT HS35AB1024-FC	A783A	✓	202												
KIT HS35AB2048-FC	A784A	✓	202												
KIT HS35AB1024-NV	A779A	✓	202												
KIT HS35AB2048-NV	A780A	✓	202												
KIT HSD351024-FC	A712	✓	202												
KIT HSD351024-NV	A711	✓	202												
KIT L449BBFS-322	A795	✓	201												
KIT L449TEBC	A796	✓	201												
KIT LDRDCR-M	A803	✓	199												
KIT LKSR02	A763	✓	202												
KIT LKSR03	A764	✓	202												
KIT LKSR512	A785	✓	202												
KIT LKSR-CFACE	A786	✓	202												
KIT M31024-FC	A754	✓	202												
KIT M31024-NV	A753	✓	202												
KIT M561024-BC	A794	✓	202												
KIT M561024BRK-140	A748	✓	202												
KIT M561024BRK-182	A749	✓	202												
KIT M561024-NV	A793	✓	202												
KIT M851024BRK-184	A750	✓	202												
KIT M851024BRK-190	A751	✓	202												
KIT M851024BRK-250	A752	✓	202												
KIT SGR-0.625-UK	A499-1	✓	203												
KIT SGR-0.875-UK	A499-2	✓	203												
KIT SGR-1.125-UK	A499-3	✓	203												
KIT SGR-1.375-UK	A499-4	✓	203												
KIT SGR-1.625-UK	A499-5	✓	203												
KIT SGR-1.875-UK	A499-6	✓	203												
KIT SGR-2.125-UK	A499-7	✓	203												
KIT SGR-2.375-UK	A499-8	✓	203												
KIT SGR-2.875-UK	A499-9	✓	203												
KIT SGR-3.375-UK	A499-10	✓	203												
KIT SGR-11.2	A500-5	✓	203												
KIT SGR-14.4	A500-8	✓	203												
KIT SGR-20.7	A500-14	✓	203												
KIT SGR-27.1	A500-20	✓	203												
KIT SGR-33.4	A500-26	✓	203												
KIT SGR-39.8	A500-32	✓	203												
KIT SGR-46.1	A500-38	✓	203												
KIT SGR-52.5	A500-44	✓	203												
KIT SGR-58.8	A500-50	✓	203												
KIT SGR-71.5	A500-62	✓	203												
KIT SGR-84.2	A500-74	✓	203												

Marathon Electric Manufacturing Corporation

MPN411 Terms and Conditions of Sale

REGAL-BELOIT CORPORATION ELECTRICAL GROUP TERMS AND CONDITIONS OF SALE ALL QUOTATIONS ARE MADE AND ALL ORDERS ARE ACCEPTED BY REGAL-BELOIT CORPORATION ELECTRICAL GROUP SUBJECT ONLY TO THESE TERMS AND CONDITIONS. THROUGHOUT THIS DOCUMENT, REGAL-BELOIT CORPORATION ELECTRICAL GROUP SHALL BE REFERRED TO AS SELLER.

1. MODIFICATIONS OF SALES TERMS:

Any Terms and Conditions contained in any purchase order or other form of communication from Seller's customers which are additional to or different from these Terms and Conditions shall be deemed rejected by Seller unless expressly accepted in writing by Seller. In general, no modification, amendment, waiver or other change of any of these Terms and Conditions and those contained on the reverse side hereof and/or in attachments hereto ("Terms and Conditions"), or of any of Seller's rights or remedies thereunder, shall be binding on Seller unless expressly accepted in writing by Seller's authorized officers. No course of dealing, usage of trade or course of performance shall be relevant to explain or supplement any of these Terms and Conditions. In case of conflict between the Terms and Conditions printed on this page and those contained on the face side or in attachments hereto, the latter shall control. If any document issued by any party hereto is sent by facsimile or another form of electronic document transmission, the parties hereto agree that (a) the copy of any such document printed on the facsimile machine or printer of the recipient thereof is a counterpart original copy thereof and is a "writing", (b) delivery of any such document to the recipient thereof by facsimile or such other form of electronic document transmission is authorized by the recipient thereof and is legally sufficient for all purposes as if delivered by United States mail, (c) the typewritten name of an authorized agent of the party sending such document on any such document is sufficient as a signature thereon on behalf of such party and the intent of such signature is to authenticate the writing, and (d) an electronically stored and reproduced copy of any such document shall be deemed to be legally sufficient evidence of the terms of such document for all purposes.

2. ACCEPTANCE OF ORDERS:

Acceptance by Seller of Buyer's purchase order(s) is expressly conditioned upon Buyer's assent to these Terms and Conditions. Buyer will be deemed to have assented to such Terms and Conditions unless Seller receives written notice of any objections within fifteen (15) days after Buyer's receipt of this form and in all events prior to any delivery or other performance by Seller of Buyer's order.

3. QUOTATIONS:

Quotations by Seller shall be deemed to be offers by Seller to sell the Goods described therein subject to these Terms and Conditions, and acceptance of such offers is expressly limited to acceptance by Buyer of all of these Terms and Conditions within thirty (30) days from the date of the quotation. Purchase orders submitted by Buyer for the Goods quoted by Seller shall be subject to and will be deemed to constitute acceptance of these Terms and Conditions. All purchase orders will be subject to approval by Seller.

4. PRICES; PRICE CHANGES:

All prices are net F.O.B. shipping point and are subject to change without notice. In the event of a change in Seller's prices, the price for Goods unshipped will be the price in effect on the date of shipment.

If Seller's quoted price was based upon delivery to and acceptance by Buyer of a specified quantity of Goods, such price shall be subject to adjustment if Buyer does not accept the quantity at the times specified in Seller's quotation, and Buyer will be invoiced at Seller's standard price without quantity discounts, if any, for the quantity of Goods actually accepted by Buyer.

5. TAXES:

In addition to any prices, Buyer shall pay the amount of any present or future manufacturer's tax, retailer's occupation tax, use tax, sales tax, excise tax, duty, custom, inspection or testing fee, or any other tax, fee or charge of any nature whatsoever imposed by any governmental authority, on or measured by the transaction between Seller and Buyer. In the event Seller is required to pay any such tax, fee or charge, Buyer shall reimburse Seller therefor; or, in lieu of such payment, Buyer shall provide Seller at the time the order is submitted with an exemption certificate or other document acceptable to the authority imposing such tax, fee or charge.

6. TERMS OF PAYMENT:

All orders are subject to the approval of Seller. Terms of payment are cash in full no later than thirty (30) days from date of shipment, without discount. If, during the period of performance of an order, the financial condition of Buyer is determined by Seller not to justify the terms of payment specified, Seller may demand full or partial payment in advance before proceeding with the work, or satisfactory security or guarantees that invoices will be promptly paid when due, or, at its option without prejudice to other lawful remedies, may defer delivery or cancel this contract. If delivery is deferred, the Goods may be stored as provided in Section 9 hereof and Seller may submit a new estimate of cost for completion based on prevailing conditions. If Buyer defaults in any payment when due, or in the event any voluntary or involuntary bankruptcy or insolvency proceedings involving Buyer are initiated by or against Buyer, then the whole contract price shall immediately become due and payable upon demand, or Seller, at its option without prejudice to its other lawful remedies, may defer delivery or cancel this contract.

Prorata payments shall become due as shipments are made. If shipments are delayed by the Buyer for any cause, payments shall become due from the date on which Seller is prepared to make shipment and storage shall be the Buyer's risk and expense as provided in Section 9 hereof. If manufacture is delayed by the Buyer for any cause, a partial payment based upon the

proportion of the order completed shall become due from the date on which Seller is notified of the delay.

7. DELIVERY; RISK OF LOSS:

All sales are F.O.B. Seller's plant or other point of shipment designated by Seller. Shipping dates are estimates only which are not guaranteed and are based upon prompt receipt from Buyer of all necessary shipping and other information. Seller reserves the right to make delivery in installments, all installments to be separately invoiced and paid for by Buyer when due per invoice, without regard to subsequent deliveries. Delivery of Goods to a commercial carrier at Seller's plant or other loading point shall constitute delivery to Buyer, and any risk of loss and further cost and responsibility thereafter for claims, delivery, loss or damage, including, if applicable, placement and storage, shall be borne by Buyer. When Goods are delivered by Seller's truck, unloading at Buyer's dock shall constitute delivery to Buyer. Claims for shortages or other errors in delivery must be made in writing to Seller within ten (10) days after receipt of shipment and failure to give such notice shall constitute unqualified acceptance and a waiver of all such claims by Buyer. Claims for loss or damage to Goods in transit by common carrier must be made to the carrier and not to Seller.

Freight and handling charges by Seller may not reflect actual freight charges prepaid to the carrier by Seller due to incentive discounts earned by Seller based upon Seller's aggregate volume of freight tendered to a carrier or when a carrier must be used which charges a rate which is different than the rate upon which Seller's freight and handling charges were based. When shipments are delivered in Seller's private trucks Buyer will be charged an amount approximating the prevailing common carrier rate.

8. EXCUSABLE DELAYS; FORCE MAJEURE:

Seller shall not be liable for any ordinary, incidental, or consequential loss or damage as a result of Seller's delay in or failure of delivery or installation due to (i) any cause beyond Seller's reasonable control, (ii) an act of God, act of the Buyer, embargo or other government act, authority, regulation or request, fire, theft, accident, strike, slowdown or other labor disturbance, war, riot, delay in transportation, or (iii) inability to obtain necessary labor, materials, components, or facilities. Should any of the aforementioned events of force majeure occur, Seller, at its option, may cancel Buyer's order with respect to any undelivered Goods or extend the delivery date for a period equal to the time lost because of delay. Notice of such election shall be given promptly to Buyer. In the event Seller elects to so cancel the order, Seller shall be released of and from all liability for failure to deliver the Goods, including, but not limited to, any and all claims on behalf of Buyer for lost profits, or any other claim of any nature which Buyer might have.

If shipping or progress of the work is delayed or interrupted by Buyer, directly or indirectly, Buyer shall pay Seller for all additional charges resulting therefrom.

9. STORAGE:

If the Goods are not shipped within thirty (30) days after notification has been made to Buyer that it is ready for shipping, for any reason beyond Seller's control, including Buyer's failure to give shipping instructions, Seller may store the Goods at Buyer's risk and expense in a warehouse or on Seller's premises, and Buyer shall pay all handling, transportation and storage costs at the prevailing commercial rates promptly following Seller's submission of invoices for such costs.

10. WARRANTIES TO DISTRIBUTORS AND INDUSTRIAL OR COMMERCIAL CUSTOMERS:

This warranty is extended only to Seller's distributors and industrial or commercial customers and does not apply to consumer purchasers.

Warranty Period - Motors

The Seller warrants motors manufactured by or for it to be free from defects in materials and workmanship and to conform to its written specifications for a period of twelve (12) months from date of first use or eighteen (18) months from date of manufacture, whichever period shall expire first.

Warranty Period - Generators

(a) The Seller warrants standby generators manufactured by or for it to be free from defects in materials and workmanship and to conform to its written specifications for a period of twenty-four (24) months from date of startup, thirty (30) months from date of shipment, or one-thousand (1,000) hours in use, whichever period shall expire first; (b) Seller warrants continuous duty generators manufactured by or for it to be free from defects in materials and workmanship and to conform to its written specifications for a period of twelve (12) months from date of startup or eighteen (18) months from date of shipment, whichever period shall expire first.

Certain Electrical Group Goods are warranted for different periods of time under specific conditions. Buyer must consult the current product catalog or internet site to confirm this warranty period.

Warranty Remedies - If, prior to expiration of the foregoing applicable warranty period, any of such Goods shall be proved to Seller's satisfaction to be defective or nonconforming, Seller will repair or replace such defective Goods or components thereof, F.O.B. Seller's plant or other destination designated by Seller, or will refund or provide Buyer with a credit in the amount of the purchase price paid therefor by Buyer, at Seller's sole option. Buyer's exclusive remedy and Seller's sole obligation under this warranty shall be limited to such repair or replacement, F.O.B. Seller's plant or other destination designated by Seller, or refund or credit by Seller, and shall be conditioned upon Seller's receiving written notice of any defect within a reasonable period of time (but in no event more than sixty (60) days) after it was discovered or by reasonable care should have been discovered. In no event shall Seller's liability for such defective or nonconforming Goods exceed the purchase price paid by Buyer therefor.

Exclusions - This warranty does not: (i) cover shipping expenses to and

Marathon Electric Manufacturing Corporation

MPN411 Terms and Conditions of Sale

from Seller's factory or other destination designated by Seller for repair or replacement of defective Goods or any tax, duty, custom, inspection or testing fee, or any other charge of any nature related thereto, nor does it cover the costs of disassembling or removing defective Goods or reassembling, reinstalling, or testing repaired or replaced Goods or finishing the reinstallation thereof; (ii) apply and shall be void with respect to Goods operated in excess of rated capacity or otherwise not in accordance with installation, maintenance, or operating instructions or requirements, to Goods repaired or altered by others than Seller or Seller's authorized service agencies, or to Goods which were subjected to abuse, negligence, misuse, misapplication, accident, damages by circumstances beyond Seller's control, to improper installation (if by others than Seller), operation, maintenance or storage, or to other than normal use or service; and (iii) apply to equipment or components not manufactured by or for Seller. With respect to Goods or components not manufactured by Seller, Seller's warranty obligations shall in all respects conform and be limited to the warranty actually extended to Seller by its suppliers, but in no event shall Seller's obligations be greater than those provided under Seller's warranty set forth in this Section 10.

THE FOREGOING WARRANTIES ARE IN LIEU OF ALL OTHER EXPRESS AND IMPLIED WARRANTIES (EXCEPT TITLE), INCLUDING, WITHOUT LIMITATION, THE IMPLIED WARRANTIES OF MERCHANTABILITY AND FITNESS FOR A PARTICULAR PURPOSE. NO EMPLOYEE, REPRESENTATIVE, OR AGENT OF SELLER OTHER THAN AN OFFICER OF SELLER IS AUTHORIZED TO ALTER OR MODIFY ANY PROVISION OF THIS SECTION 10 OR TO MAKE ANY GUARANTEE, WARRANTY, OR REPRESENTATION, EXPRESS OR IMPLIED, ORALLY OR IN WRITING, WHICH IS CONTRARY TO THE FOREGOING. Any description of the Goods, whether in writing or made orally by Seller or Seller's agents, specifications, samples, models, bulletins, drawings, diagrams, engineering sheets or similar materials used in connection with Buyer's order are for the sole purpose of identifying the Goods and shall not be construed as an express warranty. Any suggestions by Seller or Seller's agents regarding use, application or suitability of the Goods shall not be construed as an express warranty unless confirmed to be such in writing by Seller's authorized officer.

11. LIMITATIONS OF LIABILITY; CONSEQUENTIAL DAMAGES:

Nuclear Use Disclaimer - Goods sold by Seller are not intended for use in connection with any nuclear facility or activity. If so used, Seller disclaims all liability for any nuclear damage, injury or contamination, and Buyer shall indemnify and hold Seller, its officers, agents, employees, successors, assigns and customers harmless from and against any and all losses, damages or expenses of whatever form or nature (including attorneys' fees and other costs of defending any action) which they or any of them may sustain or incur, whether as a result of breach of contract, warranty, tort (including negligence) or otherwise, by reason of such use.

Consequential Damage Disclaimer - Seller's liability with respect to Goods proved to its satisfaction to be defective within the warranty period shall be limited to repair, replacement or refund as provided in Section 10 hereof, and in no event shall Seller's liability exceed the purchase price of the Goods involved. Seller shall not be subject to any obligations or liabilities, whether arising out of breach of contract, warranty, tort (including negligence) or other theories of law, with respect to Goods sold or services rendered by Seller, or any undertakings, acts or omissions relating thereto. Without limiting the generality of the foregoing, Seller specifically disclaims any liability for property or personal injury damages, penalties, special or punitive damages, damages for lost profits or revenues, loss of use of Goods or any associated Goods, cost of capital, cost of substitute products, facilities or services, downtime, shutdown, or slowdown costs, or for any other types of economic loss, and for claims of Buyer's customers for any such damages.

SELLER SHALL NOT BE LIABLE FOR AND DISCLAIMS ALL CONSEQUENTIAL, INCIDENTAL AND CONTINGENT DAMAGES WHATSOEVER. EVEN IF THE REPAIR OR REPLACEMENT REMEDY SHALL BE DEEMED TO HAVE FAILED OF ITS ESSENTIAL PURPOSE UNDER SECTION 2-719 OF THE UNIFORM COMMERCIAL CODE, SELLER SHALL HAVE NO LIABILITY TO BUYER FOR CONSEQUENTIAL DAMAGES, SUCH AS LOST PROFITS, LOST REVENUE, DAMAGE TO OTHER GOODS OR LIABILITY OR INJURY TO A THIRD PARTY.

12. INDEMNIFICATION BY BUYER:

Buyer shall indemnify, hold harmless, and defend Seller and Seller's employees and agents from and against any and all damages, liability, claims, losses, and expenses (including reasonable attorneys' fees, court costs, and out-of-pocket expenses) arising out of or resulting in any way from claims by customers of Buyer or third parties against Seller alleging a breach of contract or warranty by Seller to the extent that such damages, liability, claims, losses, and expenses which may be payable by Seller to Buyer pursuant to and as limited by Seller's warranty and damage obligations as contained in Sections 10 and 11 hereof so as to effectively limit Seller's obligations to customers of Buyer or third parties to those set forth in Sections 10 and 11 hereof.

13. PATENT INDEMNIFICATION:

Seller will, at its own expense, defend or settle any suits that may be instituted against Buyer for alleged infringement by the Goods of any United States patent, provided that: (a) such alleged infringements consist of the use of the Goods for any of the purposes for which such Goods were sold; (b) Buyer shall have made all payments for such Goods then due hereunder; (c) Buyer shall give Seller immediate notice in writing of any such suit and transmit to Seller immediately upon receipt of all processes and papers served upon Buyer; and (d) Buyer shall permit Seller through its counsel, either in the name of Buyer or in the name of Seller, to defend such suit(s) and give all needed information,

assistance and authority to enable Seller to do so.

In case of a final award of damages in any such suit, Seller will pay such award but will not be responsible for any compromise or settlement made without its written consent. In case the Goods itself is in such suit held to infringe any valid patent issued in the United States and its use enjoined, or in the event of a settlement or compromise approved by Seller which shall preclude future use of the Goods sold to Buyer hereunder, Seller shall, at its own expense and at its sole option, either: (a) procure rights to continue using such Goods; (b) modify the Goods to render it noninfringing; (c) replace the Goods with non-infringing Goods; or (d) refund the purchase price paid by Buyer for the Goods after return of the Goods to Seller. Notwithstanding the foregoing, Seller shall not be held responsible for infringements of combination or process patents covering the use of Goods in combination with other Goods or materials not furnished by Seller.

The foregoing states the entire liability of Seller for patent infringement, and **IN NO EVENT SHALL SELLER BE LIABLE FOR CONSEQUENTIAL OR INCIDENTAL DAMAGES ATTRIBUTABLE TO AN INFRINGEMENT** nor for infringement based on the use of the Goods for a purpose other than that for which sold by Seller. As to any Goods furnished by Seller to Buyer manufactured in accordance with designs proposed or furnished by Buyer or any claim of contributory infringement resulting from the use or resale by Buyer of Goods sold hereunder, Buyer shall indemnify Seller for any award made against Seller or settlement by Seller for any patent, trademark or copyright infringements including attorneys' fees and defense costs.

14. SECURITY AGREEMENT AND FINANCING STATEMENTS:

To secure payment of the purchase price and of all monies which may be due hereunder, and performance of all of Buyer's obligations hereunder, Buyer hereby grants to Seller a security interest in all Goods sold by Seller, and agrees to execute such other Security Agreements and Financing Statements as Seller may reasonably request.

15. INSURANCE:

Until payment in full of the purchase price, Buyer shall maintain insurance covering all Goods sold by Seller to Buyer in such amounts and against such risks as is customary by companies engaged in the same or similar business and similarly located, and shall, upon Seller's request, furnish evidence of such insurance satisfactory to Seller.

16. DRAWINGS; OTHER DESIGN DATA:

All specifications, drawings, designs, data, information, ideas, methods, tools, gages, dies, fixtures, patterns and/or inventions made, conceived, developed or acquired by Seller in connection with procuring and/or executing Buyer's order will vest in and inure to Seller's sole benefit notwithstanding any changes thereof which may have been or may be imposed by Seller.

Buyer shall not give, loan, exhibit, sell or transfer to any person not then employed by Buyer and authorized to receive such information, or to any organization or entity, any drawing, photograph or specification furnished by Seller or reproduction thereof which may enable such person, organization or entity to furnish similar Goods or parts therefor.

17. RETURN OF GOODS:

No Goods or part shall be returned to Seller without written authorization and shipping instructions first having been obtained from Seller.

18. ASSIGNMENT AND SUBCONTRACTING:

None of the Buyer's rights under any order shall be assigned by the Buyer to any other person, whether by operation of law or otherwise, without Seller's prior written approval. Seller may, without the necessity of obtaining Buyer's prior written consent, subcontract the production of all or any portion of the Goods.

19. CANCELLATION:

No order submitted to Seller may be cancelled by Buyer without the prior written consent of Seller, which consent will at all times be conditioned on Buyer's agreement to pay Seller's cancellation charge. For finished Goods which in Seller's judgement is readily resalable to others, the cancellation charge shall be 15% of the invoice price of the Goods. For all other cancellations, the cancellation charge shall amount to all cost and expenses incurred by Seller and arising out of or in connection with Buyer's order, net of recoverability, but in no event less than 10% of the invoice price of the Goods or more than the invoice price.

20. GENERAL:

Governing law - These Terms and Conditions, and the contract of sale between Seller and Buyer, shall be governed by and construed in accordance with the laws of the State of Wisconsin. Seller and Buyer hereby agree that any legal action deemed necessary by either party hereto shall be brought in the Circuit Court in and for Seller County, Wisconsin and hereby consent to the personal jurisdiction of such court in any such action over the parties hereto. The rights and obligations of Seller and Buyer shall not be governed by the provisions of the United Nations Convention on Contracts for the Internal Sale of Goods.

Attorneys' Fees - Buyer agrees to pay all of Seller's costs and expenses of collection and related litigation, including but not limited to attorneys' fees and costs.

Severability - The invalidity, in whole or in part, of any of the provisions of these Terms and Conditions, shall not affect the enforceability of any of the other provisions thereof.

Applicability - The Terms and Conditions as stated herein are applicable as of the date of this printing and until such time as changed by Seller.





IMPORTANT INFORMATION

Please Read Carefully



This catalog is not intended to provide operational instructions. Appropriate Marathon Electric instructions provided with the motor and precautions attached to the motor should be read carefully prior to installation, operation and/or maintenance of the equipment. Injury to personnel or motor failure may be caused by improper installation, maintenance or operation.

The following and information is supplied to you for your protection and to provide you with many years of trouble free and safe operation of your Marathon Electric product:



- Disconnect power and lock out driven equipment before working on a motor.
- Always keep hands and clothing away from moving parts.
- The lifting support on the motor is not to be used to lift the entire machine. Only the motor attached directly to the support may be safely lifted by the support.
- Install and ground per local and national codes.
- Discharge all capacitors before servicing a single phase motor.
- Misapplication of a motor in a hazardous environment can cause fire or an explosion and result in serious injury. Only the end user, local authority having jurisdiction, and/or insurance underwriter are qualified to identify the appropriate class(es), group(s), division and temperature code. Marathon Electric personnel can not evaluate or recommend what motors may be suitable for use in hazardous environments. If a motor is nameplated for hazardous locations, do not operate the motor without all of the grease and drain plugs installed.
- Never attempt to measure the temperature rise of a motor by touch. Temperature rise must be measured by thermometer, resistance, imbedded detector or thermocouple.
- Motors with automatic reset thermal protectors will automatically restart when the protector temperature drops sufficiently. Do not use motors with automatic reset thermal protectors in applications where automatic restart will be hazardous to personnel or equipment.
- Motors with manual reset thermal protectors may start unexpectedly after the protector trips when the surrounding air is at +20°Fahrenheit or lower. If the manual reset protector trips, disconnect motor from its power supply. After the protector cools (five minutes or more), it can be reset and power may be applied to the motor.
- Connect all protective device leads, marked P1, P2, etc., per instructions supplied with the motor.
- Operation of a motor at other than its nameplate rating may result in fire, damage to equipment or serious injury to personnel.
- For safety, Buyer or User should provide protective guards over all shaft extensions and any moving apparatus mounted thereon. The User is responsible for checking all applicable safety codes in his area and providing suitable guards. Failure to do so may result in bodily injury and/or damage to equipment.



- Consult qualified personnel with questions and all electrical repairs must be performed by trained and qualified personnel only.
- For motors nameplated as "belted duty only", do not operate the motor without belts properly installed.
- Motors and/or driven equipment should not be operated faster than their rated speed.
- For inverter applications, follow the inverter manufacturer's installation guidelines.
- Make sure the motor is properly secured and aligned before operation.

Resale of Goods

In the event of the resale of any of the goods, in whatever form, Resellers/Buyers will include the following language in a conspicuous place and in a conspicuous manner in a written agreement covering such sale:

The manufacturer makes no warranty or representations, express or implied, by operation of law or otherwise, as to the merchantability or fitness for a particular purpose of the goods sold hereunder. Buyer acknowledges that it alone has determined that the goods purchased hereunder will suitably meet the requirements of their intended use. In no event will the manufacturer be liable for consequential, incidental or other damages. Even if the repair or replacement remedy shall be deemed to have failed of its essential purpose under Section 2-719 of the Uniform Commercial Code, the manufacturer shall have no liability to Buyer for consequential damages.

Resellers/Buyers agree to also include this entire document including the warnings and cautions above in a conspicuous place and in a conspicuous manner in writing to instruct users on the safe usage of the product.

This information should be read together with all other printed information supplied by Marathon Electric.

For more information contact: **Marathon Electric Manufacturing Corporation**, Subsidiary of REGAL-BELOIT CORPORATION, 100 E. Randolph St., Wausau, WI 54401 Phone: 715-675-3311 or Fax: 715-675-8030.

FREQUENTLY ASKED QUESTIONS

ENERGY INDEPENDENCE AND SECURITY ACT OF 2007 (“EISA”)

These materials are intended to provide general information (not legal or other advice) about important new legislation or developments. These materials are not intended to substitute for a thorough analysis of the subject covered or any subsequent developments relating to that subject.

Q. Are medium voltage motors covered by EISA?

A. No. EISA only covers motors that are operational at 60 Hz with voltages through 600 V.

Q. Must 60/50 Hz rated motors meet EISA efficiencies?

A. Yes, 60/50 Hz motors must comply with the applicable efficiency requirement at the 60 Hz rating. 50 Hz only motors are exempt.

Q. What efficiencies are documented in NEMA tables 12-11, 12-12, 12-13 and 12-14?

A. NEMA table 12-11 defines efficiencies associated with EAct. 12-12 contains efficiencies associated with NEMA Premium (former CEE efficiencies). 12-13 defines medium voltage (>600V). 12-14 defines NEMA Premium levels @ 50 Hz.

Q. Must spread voltage (eg. 200-230/460V) or tri-voltage (eg. 230/460/796) rated motors meet EISA efficiencies at all rated voltages?

A. Yes. The motor must meet the required efficiency at each rated voltage on the nameplate. Note that since the efficiency requirements of the stated voltages may vary (200V must meet “EAct”/Table 12-11, whereas 230 & 460 must meet “NEMA Premium”/Table 12-12), varying efficiency claims must be made on the same nameplate.

Q. What about 208 volt?

A. Our view on 208 volt, is that it must meet EAct efficiencies.

Q. Are single phase motors covered by EISA?

A. No, regardless of motor frame size or HP rating.

Q. Are 48 and 56 frame motors covered by EISA?

A. No. However there are discussions about the possible establishment of efficiency standards for fractional HP motors.

Q. Are “inverter duty” motors covered by EISA?

A. Yes, if the motor is operational at 60 Hz. If the motor can be used as a “general purpose” motor, it must meet EISA-mandated efficiency. Special V/Hz motors (eg. 45Hz/230V) are not covered, nor are special ventilation schemes such as blower cooled or TENV.

Q. Are motors that are intermittent duty or 60 minute duty covered?

A. Motors that are truly intermittent duty or time limited and will fail if operated continuously are not covered. Motors that are labeled for less than continuous duty but are capable of operating continuously are covered.

Q. Are motors with brakes covered? What about gearmotors?

A. Motors that have brakes installed on the motor are not covered. Motors that are purchased with a shaft extension or “brake provisions” are covered. Motors that are part of the gear assembly and share bearings or other components such that they cannot operate without the gear assembly are not covered. Motors that can be operated separately but are used with a gearbox are covered.

Q. Are motors with encoders or encoder provisions covered?

A. Yes, both motor with encoders and motors with encoder provisions are covered based upon their other features such as enclosure, voltage and frequency. The inclusion of an encoder or other accessories is not required for the motor to operate so they are not considered reasons for exemption.

Q. Are multi-speed motors covered?

A. No, multi-speed motors (ex: 25/12.5hp 1800/900rpm) are not covered. There are no efficiency levels established for multi-speed motors so they cannot be labeled as EAct or NEMA Premium regardless of the efficiency value.

Q. Are eight (8) pole motors covered?

A. Yes, eight-pole motors operating on 60Hz power supplies are covered. There are no NEMA Premium efficiency levels defined for eight-pole motors so they cannot be labeled as NEMA Premium even if the efficiency exceeds EAct (Table 12-11) levels.

NEMA MG-1 Table 12-11 Full Load Efficiencies of EPA Act Efficient Electric Motors

HP	NOMINAL FULL LOAD EFFICIENCY							
	OPEN FRAME				ENCLOSED FRAME			
	2 POLE	4 POLE	6 POLE	8 POLE	2 POLE	4 POLE	6 POLE	8 POLE
1	N/A	82.5	80.0	74.0	75.5	82.5	80.0	74.0
1 1/2	82.5	84.0	84.0	75.5	82.5	84.0	85.5	77.0
2	84.0	84.0	85.5	85.5	84.0	84.0	86.5	82.5
3	84.0	86.5	86.5	86.5	85.5	87.5	87.5	84.0
5	85.5	87.5	87.5	87.5	87.5	87.5	87.5	85.5
7 1/2	87.5	88.5	88.5	88.5	88.5	89.5	89.5	85.5
10	88.5	89.5	90.2	89.5	89.5	89.5	89.5	88.5
15	89.5	91.0	90.2	89.5	90.2	91.0	90.2	88.5
20	90.2	91.0	91.0	90.2	90.2	91.0	90.2	89.5
25	91.0	91.7	91.7	90.2	91.0	92.4	91.7	89.5
30	91.0	92.4	92.4	91.0	91.0	92.4	91.7	91.0
40	91.7	93.0	93.0	91.0	91.7	93.0	93.0	91.0
50	92.4	93.0	93.0	91.7	92.4	93.0	93.0	91.7
60	93.0	93.6	93.6	92.4	93.0	93.6	93.6	91.7
75	93.0	94.1	93.6	93.6	93.0	94.1	93.6	93.0
100	93.0	94.1	94.1	93.6	93.6	94.5	94.1	93.0
125	93.6	94.5	94.1	93.6	94.5	94.5	94.1	93.6
150	93.6	95.0	94.5	93.6	94.5	95.0	95.0	93.6
200	94.5	95.0	94.5	93.6	95.0	95.0	95.0	94.1
250	94.5	95.4	95.4	94.5	95.4	95.0	95.0	94.5
300	95.0	95.4	95.4	N/A	95.4	95.4	95.0	N/A
350	95.0	95.4	95.4	N/A	95.4	95.4	95.0	N/A
400	95.4	95.4	N/A	N/A	95.4	95.4	N/A	N/A
450	95.8	95.8	N/A	N/A	95.4	95.4	N/A	N/A
500	95.8	95.8	N/A	N/A	95.4	95.8	N/A	N/A

NEMA TABLE 12-11

NEMA MG-1 Table 12-12 Full Load Efficiencies for 60 Hz NEMA Premium® (CEE)

Efficient Electric Motors Rated 600 Volts or less (Random Wound)

HP	NOMINAL FULL LOAD EFFICIENCY							
	OPEN FRAME				ENCLOSED FRAME			
	2 POLE	4 POLE	6 POLE	8 POLE	2 POLE	4 POLE	6 POLE	8 POLE
1	77.0	85.5	82.5	N/A	77.0	85.5	82.5	N/A
1 1/2	84.0	86.5	86.5	N/A	84.0	86.5	87.5	N/A
2	85.5	86.5	87.5	N/A	85.5	86.5	88.5	N/A
3	85.5	89.5	88.5	N/A	86.5	89.5	89.5	N/A
5	86.5	89.5	89.5	N/A	88.5	89.5	89.5	N/A
7 1/2	88.5	91.0	90.2	N/A	89.5	91.7	91.0	N/A
10	89.5	91.7	91.7	N/A	90.2	91.7	91.0	N/A
15	90.2	93.0	91.7	N/A	91.0	92.4	91.7	N/A
20	91.0	93.0	92.4	N/A	91.0	93.0	91.7	N/A
25	91.7	93.6	93.0	N/A	91.7	93.6	93.0	N/A
30	91.7	94.1	93.6	N/A	91.7	93.6	93.0	N/A
40	92.4	94.1	94.1	N/A	92.4	94.1	94.1	N/A
50	93.0	94.5	94.1	N/A	93.0	94.5	94.1	N/A
60	93.6	95.0	94.5	N/A	93.6	95.0	94.5	N/A
75	93.6	95.0	94.5	N/A	93.6	95.4	94.5	N/A
100	93.6	95.4	95.0	N/A	94.1	95.4	95.0	N/A
125	94.1	95.4	95.0	N/A	95.0	95.4	95.0	N/A
150	94.1	95.8	95.4	N/A	95.0	95.8	95.8	N/A
200	95.0	95.8	95.4	N/A	95.4	96.2	95.8	N/A
250	95.0	95.8	95.4	N/A	95.8	96.2	95.8	N/A
300	95.4	95.8	95.4	N/A	95.8	96.2	95.8	N/A
350	95.4	95.8	95.4	N/A	95.8	96.2	95.8	N/A
400	95.8	95.8	95.8	N/A	95.8	96.2	95.8	N/A
450	95.8	96.2	96.2	N/A	95.8	96.2	95.8	N/A
500	95.8	96.2	96.2	N/A	95.8	96.2	95.8	N/A

NEMA TABLE 12-12



NEMA Quick Reference Dimensional Chart

NEMA C-Face	BA Dimensions
143-5TC	2-3/4
182-4TC	3-1/2
213-5TC	4-1/4
254-6TC	4-3/4

Typical C-Face Motor

Contact your Marathon Electric sales representative for "AB", "O", & "P" Dimensions.

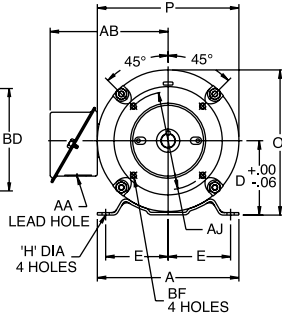
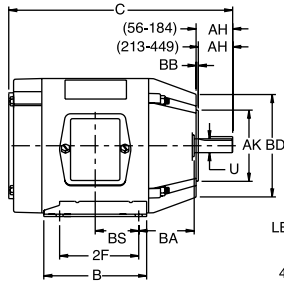

Typical Rigid Base Motor

Refer to your Marathon Electric catalog for "C" Dimensions.

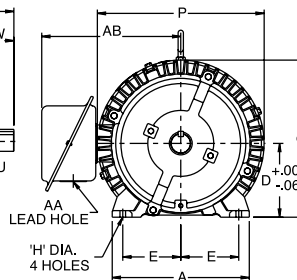
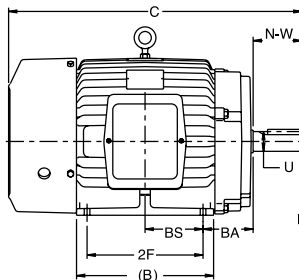

FRAME	D	E	2F	H	U	N-W	AA	AH	AJ	AK	BA	BB (MIN)	BD (MAX)	BF
48	3.00	2.12	2.75	.34 SLOT	.5000	1.50	1/2	1.69	3.750	3.000	2.50	.13	5.62	1/4-20
56	3.50	2.44	3.00	.34 SLOT	.6250	1.88	1/2	2.06	5.875	4.500	2.75	.13	6.50	3/8-16
56H	3.50	2.44	5.00	.34 SLOT	.6250	1.88	1/2	2.06	5.875	4.500	2.75	.13	6.50	3/8-16
143T	3.50	2.75	4.00	.34	.8750	2.25	3/4	2.12	5.875	4.500	2.25	.13	6.50	3/8-16
145T	3.50	2.75	5.00	.34	.8750	2.25	3/4	2.12	5.875	4.500	2.25	.13	6.50	3/8-16
182	4.50	3.75	4.50	.41	.8750	2.25	3/4	2.12	5.875	4.500	2.75	.13	6.50	3/8-16
184	4.50	3.75	5.50	.41	.8750	2.25	3/4	2.12	5.875	4.500	2.75	.13	6.50	3/8-16
182T	4.50	3.75	4.50	.41	1.125	2.75	3/4	2.62	7.250	8.500	2.75	.25	9.00	1/2-13
184T	4.50	3.75	5.50	.41	1.125	2.75	3/4	2.62	7.250	8.500	2.75	.25	9.00	1/2-13
213	5.25	4.25	5.50	.41	1.125	3.00	1	2.75	7.250	8.500	3.50	.25	9.00	1/2-13
215	5.25	4.25	7.00	.41	1.125	3.00	1	2.75	7.250	8.500	3.50	.25	9.00	1/2-13
213T	5.25	4.25	5.50	.41	1.375	3.38	1	3.12	7.250	8.500	3.50	.25	9.00	1/2-13
215T	5.25	4.25	7.00	.41	1.375	3.38	1	3.12	7.250	8.500	3.50	.25	9.00	1/2-13
254U	6.25	5.00	8.25	.53	1.375	3.75	1-1/4	3.50	7.250	8.500	4.25	.25	10.00	1/2-13
256U	6.25	5.00	10.00	.53	1.375	3.75	1-1/4	3.50	7.250	8.500	4.25	.25	10.00	1/2-13
254T	6.25	5.00	8.25	.53	1.625	4.00	1-1/4	3.75	7.250	8.500	4.25	.25	10.00	1/2-13
256T	6.25	5.00	10.00	.53	1.625	4.00	1-1/4	3.75	7.250	8.500	4.25	.25	10.00	1/2-13
284U	7.00	5.50	9.50	.53	1.625	4.88	1-1/2	4.62	9.000	10.500	4.75	.25	11.25	1/2-13
286U	7.00	5.50	11.00	.53	1.625	4.88	1-1/2	4.62	9.000	10.500	4.75	.25	11.25	1/2-13
284T	7.00	5.50	9.50	.53	1.875	4.62	1-1/2	4.38	9.000	10.500	4.75	.25	11.25	1/2-13
286T	7.00	5.50	11.00	.53	1.875	4.62	1-1/2	4.38	9.000	10.500	4.75	.25	11.25	1/2-13
284TS	7.00	5.50	9.50	.53	1.625	3.25	1-1/2	3.00	9.000	10.500	4.75	.25	11.25	1/2-13
286TS	7.00	5.50	11.00	.53	1.625	3.25	1-1/2	3.00	9.000	10.500	4.75	.25	11.25	1/2-13
324U	8.00	6.25	10.50	.66	1.875	5.62	2	5.38	11.000	12.500	5.25	.25	14.00	5/8-11
326U	8.00	6.25	12.00	.66	1.875	5.62	2	5.38	11.000	12.500	5.25	.25	14.00	5/8-11
324T	8.00	6.25	10.50	.66	2.125	5.25	2	5.00	11.000	12.500	5.25	.25	14.00	5/8-11
326T	8.00	6.25	12.00	.66	2.125	5.25	2	5.00	11.000	12.500	5.25	.25	14.00	5/8-11
324TS	8.00	6.25	10.50	.66	1.875	3.75	2	3.50	11.000	12.500	5.25	.25	14.00	5/8-11
326TS	8.00	6.25	12.00	.66	1.875	3.75	2	3.50	11.000	12.500	5.25	.25	14.00	5/8-11
364U	9.00	7.00	11.25	.66	2.125	6.38	2-1/2	6.12	11.000	12.500	5.88	.25	14.00	5/8-11
365U	9.00	7.00	12.25	.66	2.125	6.38	2-1/2	6.12	11.000	12.500	5.88	.25	14.00	5/8-11
364T	9.00	7.00	11.25	.66	2.375	5.88	2-1/2	5.62	11.000	12.500	5.88	.25	14.00	5/8-11
365T	9.00	7.00	12.25	.66	2.375	5.88	2-1/2	5.62	11.000	12.500	5.88	.25	14.00	5/8-11
364TS	9.00	7.00	11.25	.66	1.875	3.75	2-1/2	3.50	11.000	12.500	5.88	.25	14.00	5/8-11
365TS	9.00	7.00	12.25	.66	1.875	3.75	2-1/2	3.50	11.000	12.500	5.88	.25	14.00	5/8-11
404U	10.00	8.00	12.25	.81	2.375	7.12	3	6.88	11.000	12.500	6.62	.25	15.50	5/8-11
405U	10.00	8.00	13.75	.81	2.375	7.12	3	6.88	11.000	12.500	6.62	.25	15.50	5/8-11
404T	10.00	8.00	12.25	.81	2.875	7.25	3	7.00	11.000	12.500	6.62	.25	15.50	5/8-11
405T	10.00	8.00	13.75	.81	2.875	7.25	3	7.00	11.000	12.500	6.62	.25	15.50	5/8-11
404TS	10.00	8.00	12.25	.81	2.125	4.25	3	4.00	11.000	12.500	6.62	.25	15.50	5/8-11
405TS	10.00	8.00	13.75	.81	2.125	4.25	3	4.00	11.000	12.500	6.62	.25	15.50	5/8-11
444U	11.00	9.00	14.50	.81	2.875	8.62	3	8.38	14.000	16.000	7.50	.25	18.00	5/8-11
445U	11.00	9.00	16.50	.81	2.875	8.62	3	8.38	14.000	16.000	7.50	.25	18.00	5/8-11
444T	11.00	9.00	14.50	.81	3.375	8.50	3	8.25	14.000	16.000	7.50	.25	18.00	5/8-11
445T	11.00	9.00	16.50	.81	3.375	8.50	3	8.25	14.000	16.000	7.50	.25	18.00	5/8-11
444TS	11.00	9.00	14.50	.81	2.375	4.75	3	4.50	14.000	16.000	7.50	.25	18.00	5/8-11
445TS	11.00	9.00	16.50	.81	2.375	4.75	3	4.50	14.000	16.000	7.50	.25	18.00	5/8-11
447T	11.00	9.00	20.00	.81	3.375	8.50	3	8.25	14.000	16.000	7.50	.25	18.00	5/8-11
449T	11.00	9.00	25.00	.81	3.375	8.50	3	8.25	14.000	16.000	7.50	.25	18.00	5/8-11
447TS	11.00	9.00	20.00	.81	2.375	4.75	4 NPT	4.50	14.000	16.000	7.50	.25	18.00	5/8-11
449TS	11.00	9.00	25.00	.81	2.375	4.75	4 NPT	4.50	14.000	16.000	7.50	.25	18.00	5/8-11

Marathon Electric's "MAX" Family of AC Variable Speed Motors

Performance and Specification Comparisons



Characteristic	microMAX™	Black Max®	Blue Max®
Electrical Characteristics			
Horsepower range	1/8-10	1/4-30	1-1250
Base speed (# Poles)	4	4 and 6	2, 4, 6, 8, 10, 12
Standard Voltage	230, 230/460, 575	230/460, 575	230/460, 460, 575
Insulation Class	H	F	F (select models are H)
Insulation System	CR ²⁰⁰ magnet wire / Class H	MAX GUARD® / Class F	MAX GUARD® / Class F or H
Service Factor (inverter power)	1.0	1.0	1.0
Phase/Base Frequency	3/60	3/60	3/60
Design Code (NEMA)	A	A	A ("B" as noted)
Duty Cycle	Continuous	Continuous	Continuous
Thermal protection	None	Class F thermostats	Class F thermostats
Mechanical Characteristics			
Frame size (mounting)	56-215T	56-286T	143T-6805
Normal NEMA frame size	Yes	Yes	Yes
Enclosure	TENV & TEFC	TENV & EPNV	TENV, TEFC, TEBC, EPNV, DPFV
Frame material	Rolled Steel	Rolled Steel, Aluminum, and Cast Iron	Cast Iron
End bracket material	Aluminum	Aluminum, Cast Iron	Cast Iron
Conduit box material	Steel	Steel	Cast Iron
Fan guard material	Polypropylene	None (all ratings TENV)	Cast Iron
Fan material	Polypropylene	None (all ratings TENV)	Polypropylene
Severe Duty option	No	No	Yes
Lead termination	Terminal block (3 lead TENV) Conduit box (all others)	Conduit box	Conduit box
Standard mounting (stock)	C-Face with Rigid Base and C-Face Round Body	C-Face with Rigid Base	C-Face with Rigid Base (1-100 HP) Rigid base (TEFC and over 100 HP)
Drive end shaft slinger	No	No	Yes
Paint	Black (powder-coat or enamel)	Black (powder-coat or enamel)	Blue (powder-coat or enamel)
Bearings	Ball (C3 fit)	Ball (C3 fit)	Ball (C3 fit); 445T-up Roller
Grease	Mobil POLYREX EM	Mobil POLYREX EM	Mobil POLYREX EM
Standard conduit box assembly position	F3	F1, reversible to F2 (except 56/140 frame steel)	F1, reversible to F2 (F3 available on build-up)
Performance Characteristics			
Constant Torque speed range	20:1 (TEFC), 1000:1 (TENV)	1000:1 (TENV)	2000:1 (all enclosures) TEFC: 20:1 on V/H drives
Constant Horsepower speed range	2:1 (90-120 Hz intermittent)	2:1 (90-120 Hz intermittent)	1.5:1-4:1
Temperature rise	B	F	F (TENV & TEFC) B (TEBC)
Encoder provisions (stock motors)	No	Yes	Yes
High Breakdown Torque	Yes	Yes	Yes
Other Characteristics			
Agency listings	UL Recognized, CSA Certified, CE	UL Recognized, CSA Certified, CE	UL Recognized, CSA Certified, CE
Warranty	3 years	3 years	3 years

Footnotes

1	Capacitor Start/Capacitor Run design for reduced amperage	75	Addition of C-Face Kits may result in non-NEMA "BA", dimension. For the resulting "BA" dimension consult chart found in modification section
2	Capacitor Start Induction Run design	76	Addition of C-Face Kits in non-NEMA "AH" dimension. "AH" is 2.12, Rework "AH" is 2.38
3	Split Phase design	77	Frame size is drilled with three sets of footholes, 5010, 5011, and 5012 as standard. Foothole drilling for 5009 available upon request, as a build-up
4	Sleeve bearing	78	Frame size is drilled with two sets of footholes, 5012 and 5013 standard
5	56H, 143T, and 145T Combination Base with 12 mounting holes	79	Ball brgs on both ends suitable for direct connection. For belted applications, refer to Customer Service
6	Bolt-on removable base for footless mounting option	80	Rolled steel fan guard on 143T-145T
7	Shaft extension 1-1/2" long by 1/2" diameter	81	24" long #18 SO 2-conductor cord out shell at 11 o'clock position
8	Shaft extension 1-7/8" long by 1/2" diameter	82	Welded Rigid Base
9	Shaft extension 2-1/4" long by 1/2" diameter	83	Shaft extension 1-7/8" long by 5/8" diameter with 6-3/8" mounting flange
10	Shaft extension 2-1/4" long by 5/8" diameter	84	NEMA 145T C-Face mounting with removable 182T rigid base
11	Shaft extension 2-1/4" long by 7/8" diameter	85	Not tach adaptable
12	With rigid base	86	2:1 constant torque speed range; RTM for greater torque capability
13	F1 Mounting only, cannot reassemble to F2	87	10:1 Constant Torque available as build-up, RTM for price and availability
14	Will accept C-Face kit, see Accessory Section	88	182T base and shaft height, 145TC mounting face and shaft dimensions
15	Fixed CW Rotation, viewing opposite shaft (or lead end) of motor	89	Threaded NPT opening in conduit box
16	Fixed CCW Rotation, viewing opposite shaft (or lead end) of motor	90	Not UL Recognized
17	1.0 Service Factor	91	Suitable for use on VFD at 208 volt
18	1.15 Service Factor	92	7/8" Thru-bolts, shaft end
19	1.25 Service Factor	93	Permanent split capacitor-switchless
20	1.35 Service Factor	94	1/2" Thru-bolts, shaft end
21	Double shaft extension 1-1/2" long by 1/2" diameter with flat each end	95	Will not accept drip cover kit
22	Double shaft extension 1-7/8" long by 5/8" diameter each end	96	3 lead reversible design works with single pole, double throw reversing switch
23	Shaft extension 3/8" diameter	97	Addition of D-Flange kit will result in non-NEMA "BA" dimension (1/2" longer than NEMA) and non-NEMA shaft extension (1/2" shorter than NEMA).
24	Motor will NOT accept a Brake kit	98	Not UL Listed for Fire Pump applications
25	Motor will NOT accept C-Face Kits	99	Suitable for 2:1 CT operation
26	5/8" shaft adapter included	100	6" shaft extension with 2 flats 90° apart
27	Drip Cover included	110	1.20 Service Factor
28	Steel Endshields	111	1.30 Service Factor
29	Weep holes with removable plugs on end brackets. Remove bottom plug after installation	112	1.40 Service Factor
30	Resilient ring mount, base not included	113	1.50 Service Factor
31	5/8" Thru-bolts, shaft end	114	1.60 Service Factor
32	3/4" Thru bolts, shaft end	115	1.75 Service Factor
33	Shaft extension 6" long by 5/8" diameter with full flat and key 90° apart	116	1-3/4" thru-bolt extension on shaft-end
34	1" Thru-bolts, shaft end	2:1	Suitable for 2:1 CT operation; consult "R164 Rework" table for fan change pricing to upgrade to 10:1 CT
35	1-1/8" Thru-bolts, shaft end	A	NEMA Design A
36	1-1/4" Thru-bolts, shaft end	AH	Conforms to GM 7EH and satisfies Ford EM-1 and GM 7EQ
37	1-1/2" Thru-bolts, shaft end	AL	Aluminum Frame Construction
38	2" Thru-bolts, shaft end	AQ	Conforms to GM 7EQ and satisfies Daimler Chrysler NPEM-100, and Ford EM-1
39	No Thru-bolts, shaft end	BI	Class B Insulation
40	Space heaters and 100 ohm platinum stator RTDs included.	B	NEMA Design B
41	1/2" Thru-bolts, opposite shaft end	BP	Separate power supply required for blower motor
42	3/4" Thru-bolts, opposite shaft end	C	NEMA Design C
43	2-1/2" Resilient Rings included	CD	Suitable for Group C
44	1" Thru-bolts, opposite shaft end	CF	Consult Factory for Accessory Kit and/or Modification Selection
45	60° C ambient	CT	Suitable for 20:1 CT on Vector Drive, cont duty or 2000:1 CT, 60 min duty
46	65° C ambient	d	Will become build-up item when current stock is gone
47	Connected for CCW rotation (U.S. standard) facing opposite shaft end. Reversible by reconnection of leads	E	Design incorporates electronic switch
48	Connected for CW rotation (Canadian standard) facing opposite shaft end. Reversible by reconnection of leads	ES	Energy Saver Design
49	Shaft extension 1-13/16" long by 1/2" diameter with 6-3/8" mounting flange	F	Class F Insulation
50	Designed for 50 Hz operation	FN	Drive has cooling fan
51	Does not include resilient rings, see Accessory Section	H	Cass H Insulation
52	1/2" x 1-7/8" Shaft with 1-5/8" Flat	I	Reduced HP @ 120 HZ
53	1/2" Shaft with 5/8" adapter and Key	N	Totally Enclosed, Non-Ventilated
54	30 minute duty cycle, not rated for continuous duty	NE	Exempt from NEMA Premium efficiency requirement
55	Shaft extension 3-13/16" long by 5/8" diameter with 3.5" keyway	NP	Does not meet NEMA PremiumR efficiency
56	1-5/8" Thru-bolts, shaft end	NS	Single Shielded Ball Bearings
57	Open construction	PW	Part Winding Start Capability
58	Capacitor supplied with motor	Q	"Quick Connect" terminal board
59	TEAO construction	RB	Roller Bearing on shaft end for belted load only
60	Foot locating Set Screws on frame, 90° apart	S	Steel Frame Construction
61	10" Leads	SH	Space heaters
62	43" Leads	SL	Sound level exceeds standard
63	1-1/2" Thru-bolts, opposite shaft end	TS	Normally Closed Thermostats installed
65	Mounting accessories and resilient ring for pulley end are not included. Use accessory kit 161L131AB1 for resilient ring mounting.	V	Suitable for 10:1 CT 60 minute duty, otherwise 2:1 CT
67	Capacitor not included, see Accessory Section	VB	Vibration not met
68	Rated 60/50 hertz, 190/380 or 380 volt at next lower horsepower	VC	Voltage Change Device feature for quick voltage changes
69	50° C Ambient	X	XRI, Ultra High Efficiency Design
70	Not Nameplated 50 hz	YD	12 Leads for WYE-DELTA, Part Winding on low voltage, or across-the-line starting
71	Includes length adapter bracket	Z	56HZ with 7/8" x 2 1/4" shaft, 3-1/2" height, and slotted 56 frame base
72	Usable on 200 Volts at 1.0 service factor		
73	No hubs		
74	Split phase/capacitor run electrical design		

IEC Quick Reference Dimensional Chart

B3 Foot-Mounted (Ridge Base)

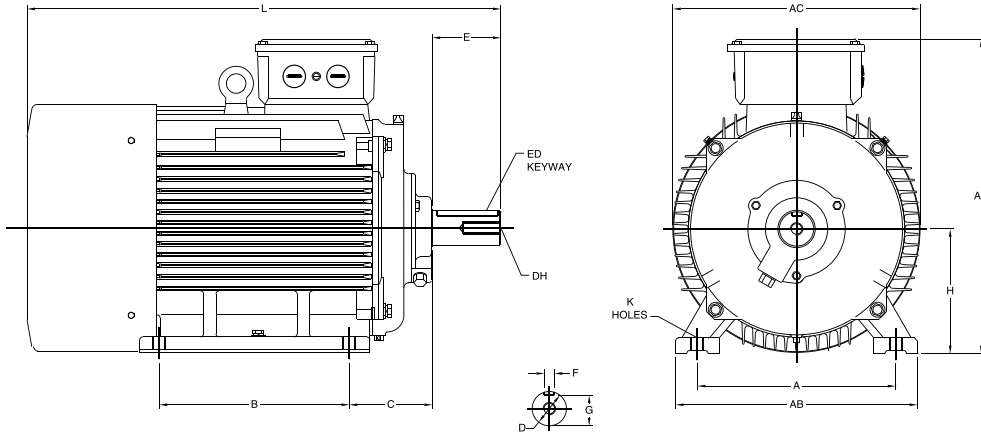

IEC Frame Dimensions (Millimeters)

FRAME	MOUNTING						SHAFT						GENERAL			B5 (FF) FLANGE						B14 (FT) FACE					
	A	B	C	H	AB	K	D	E	F	G	ED	DH	AC	AD	HD	M	N	P	S	T	LA	M	N	P	S	T	LA
63	100	80	40	63	119	7	11	23	4	8.5	10	M4 x 10	126	-	169	115	95	140	10	3.0	7	75	60	90	M5	2.5	7
71	112	90	45	71	131	7	14	30	5	11.0	20	M5 x 12.5	140	-	186	130	110	160	10	3.5	7	85	70	105	M6	2.5	9
80	125	100	50	80	157	10	19	40	6	15.5	25	M6 x 16	158	132	212	165	130	200	12	3.5	12	100	80	120	M6	3.0	9
90S	140	100	56	90	174	10	24	50	8	20.0	32	M8 x 19	178	140	230	165	130	200	12	3.5	12	115	95	140	M8	3.0	9
90L	140	125	56	90	174	10	24	50	8	20.0	32	M8 x 19	178	140	230	165	130	200	12	3.5	12	115	95	140	M8	3.0	9
100L	160	140	63	100	205	12	28	60	8	24.0	40	M10 x 22	215	178	278	215	180	250	15	4.0	11	130	110	160	M8	3.5	14
112M	190	140	70	112	245	12	28	60	8	24.0	40	M10 x 22	220	190	302	215	180	250	15	4.0	12	130	110	160	M8	3.5	11
132S	216	140	89	132	280	12	38	80	10	33.0	56	M12 x 28	275	210	342	265	230	300	15	4.0	12	165	130	200	M10	3.5	14
132M	216	178	89	132	280	12	38	80	10	33.0	56	M12 x 28	275	210	342	265	230	300	15	4.0	12	165	130	200	M10	3.5	14
160M	254	210	108	160	325	15	42	110	12	37.0	80	M16 x 36	325	254	414	300	250	350	19	5.0	13	215	180	250	M12	4.0	13
160L	254	254	108	160	325	15	42	110	12	37.0	80	M16 x 36	325	254	414	300	250	350	19	5.0	13	215	180	250	M12	4.0	13
180M	279	241	121	180	335	15	48	110	14	42.5	80	M16 x 36	360	310	490	300	250	350	19	5.0	15						
180L	279	279	121	180	335	15	48	110	14	42.5	80	M16 x 36	360	310	490	300	250	350	19	5.0	15						
200L	318	305	133	200	395	19	55	110	16	49.0	100	M20 x 42	400	340	540	350	300	400	19	5.0	19.5						
225S	356	286	149	225	435	19	55*/	110*/	16*/	49*/	100*/	M20 x 42	445	414	639	400	350	450	19	5.0	21.0						
225M	356	311	149	225	435	19	55*/	110*/	16*/	49*/	100*/	M20 x 42	445	414	639	400	350	450	19	5.0	21.0						
							60	140	18	53	125																
250M	406	349	168	250	490	24	60*/	140	18	53*/	125	M20 x 42	500	440	690	400	350	450	19	5.0	21.0						
							65		58																		

**NOT
DEFINED
BY
IEC 72**

*2 Pole Dimensions

1mm = .03937", 1" = 25.4mm

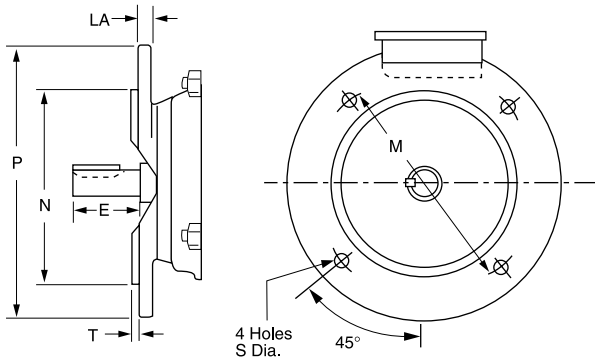

FF Flange B5 Mount

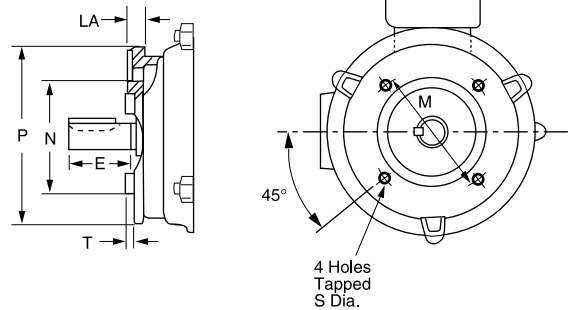

FT Face B14 Mount



100 East Randolph Street, P.O. Box 8003
Wausau, WI 54402-8003
PH: 715-675-3311

marathonelectric.com

A Regal Brand



www.regalbeloit.com